



# UNISONIC TECHNOLOGIES CO., LTD

## UT2316

Power MOSFET

### N-CHANNEL ENHANCEMENT MODE

■ DESCRIPTION

The UTC **UT2316L** is N-channel enhancement mode Power MOSFET, designed in serried ranks with fast switching speed, low on-resistance, favorable stabilization.

Used in commercial and industrial surface mount applications and suited for low voltage applications such as DC/DC converters.

■ SYMBOL

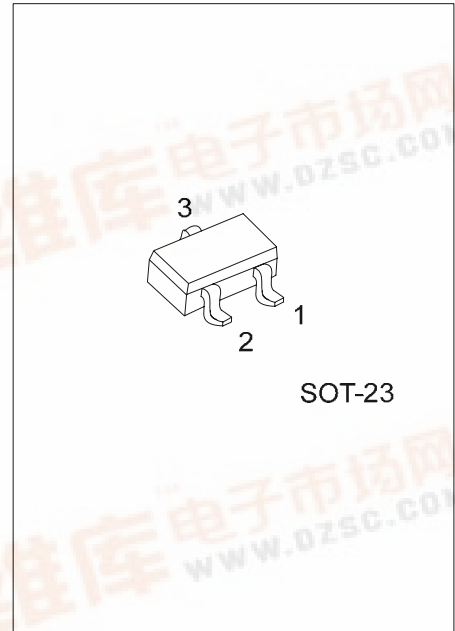
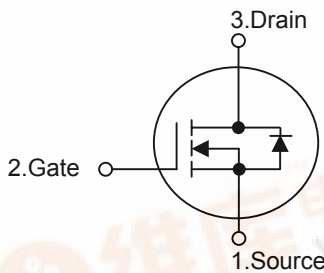

SOT-23

\*Pb-free plating product number: UT2316L

■ ORDERING INFORMATION

Ordering Number		Package	Pin Assignment			Packing
Normal	Lead Free Plating		1	2	3	
UT2316-AE3-R	UT2316L-AE3-R	SOT-23	S	G	D	Tape Reel

UT2316L-AE3-R (1) Packing Type (2) Package Type (3) Lead Plating	(1) R: Tape Reel (2) AE3: SOT-23 (3) L: Lead Free Plating, Blank: Pb/Sn
---	---

■ MARKING

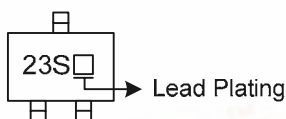

■ ABSOLUTE MAXIMUM RATINGS (Ta = 25 , unless otherwise specified)

PARAMETER	SYMBOL	RATING	UNITS
Drain-Source Voltage	V <sub>DS</sub>	30	V
Gate-Source Voltage	V <sub>GS</sub>	±20	V
Continuous Drain Current (Note 3)	I <sub>D</sub>	3.6	A
Pulsed Drain Current (Note 1, 2)	I <sub>DM</sub>	16	A
Total Power Dissipation (Ta=25 )	P <sub>D</sub>	0.96	W
Junction Temperature	T <sub>J</sub>	+150	
Storage Temperature	T <sub>STG</sub>	-55 ~ +150	

Note: Absolute maximum ratings are those values beyond which the device could be permanently damaged. Absolute maximum ratings are stress ratings only and functional device operation is not implied.

■ THERMAL DATA

PARAMETER	SYMBOL	MIN	TYP	MAX	UNIT
Junction to Ambient (Note 3)	θ <sub>JA</sub>			175	/W

■ ELECTRICAL CHARACTERISTICS (T<sub>J</sub>=25 , unless otherwise specified)

PARAMETER	SYMBOL	TEST CONDITIONS	MIN	TYP	MAX	UNITS
<b>OFF CHARACTERISTICS</b>						
Drain-Source Breakdown Voltage	BV <sub>DSS</sub>	V <sub>GS</sub> =0V, I <sub>D</sub> =250μA	30			V
Drain-Source Leakage Current	I <sub>DSS</sub>	V <sub>DS</sub> =24V, V <sub>GS</sub> =0V			1	μA
Gate-Source Leakage Current	I <sub>GSS</sub>	V <sub>DS</sub> =0V, V <sub>GS</sub> =±20V			±100	nA
<b>ON CHARACTERISTICS</b>						
Gate Threshold Voltage	V <sub>GS(TH)</sub>	V <sub>DS</sub> =V <sub>GS</sub> , I <sub>D</sub> =250μA	0.8			V
On-State Drain Current	I <sub>D(ON)</sub>	V <sub>DS</sub> = 4.5V, V <sub>GS</sub> = 10V	6			A
		V <sub>DS</sub> = 4.5V, V <sub>GS</sub> = 4.5V	4			A
Drain-Source On-State Resistance (Note 2)	R <sub>DS(ON)</sub>	V <sub>GS</sub> =10V, I <sub>D</sub> =3.4A		42	50	mΩ
		V <sub>GS</sub> =4.5V, I <sub>D</sub> =2.6A		68	85	mΩ
<b>DYNAMIC CHARACTERISTICS</b>						
Input Capacitance	C <sub>ISS</sub>	V <sub>DS</sub> =15V, V <sub>GS</sub> =0V, f=1.0MHz		215		pF
Output Capacitance	C <sub>OSS</sub>			90		pF
Reverse Transfer Capacitance	C <sub>RSS</sub>			55		pF
<b>SWITCHING CHARACTERISTICS</b>						
Turn-ON Delay Time	t <sub>D(ON)</sub>	V <sub>DD</sub> =15V, V <sub>GS</sub> =10V, I <sub>D</sub> = 1A, R <sub>G</sub> =6Ω, R <sub>L</sub> =15Ω		9	15	ns
Turn-ON Rise Time	t <sub>R</sub>			9	15	ns
Turn-OFF Delay Time	t <sub>D(OFF)</sub>			14	20	ns
Turn-OFF Fall Time	t <sub>F</sub>			6	12	ns
Total Gate Charge	Q <sub>G</sub>			4.3	7	nC
Gate-Source Charge	Q <sub>GS</sub>	V <sub>DS</sub> =15V, V <sub>GS</sub> =10V, I <sub>D</sub> =3.6A		0.65		nC
Gate-Drain Charge	Q <sub>GD</sub>			1.2		nC
<b>SOURCE- DRAIN DIODE RATINGS AND CHARACTERISTICS</b>						
Drain-Source Diode Forward Voltage(Note2)	V <sub>SD</sub>	V <sub>GS</sub> =0V, I <sub>S</sub> =0.8A		0.88	1.2	V
Maximum Continuous Drain-Source Diode Forward Current	I <sub>S</sub>	V <sub>D</sub> =V <sub>G</sub> =0V, V <sub>S</sub> =1.2V		0.8		A

- Notes: 1. Pulse width limited by T<sub>J(MAX)</sub>  
 2. Pulse width ≤300us, duty cycle ≤2%.  
 3. Surface mounted on 1 in<sup>2</sup> copper pad of FR4 board

## TYPICAL CHARACTERISTICS

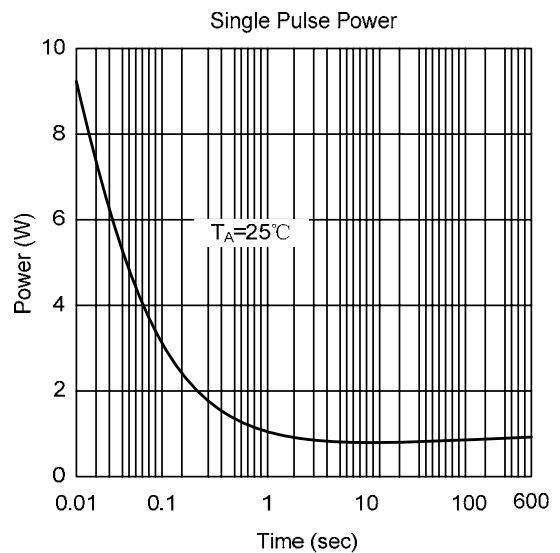
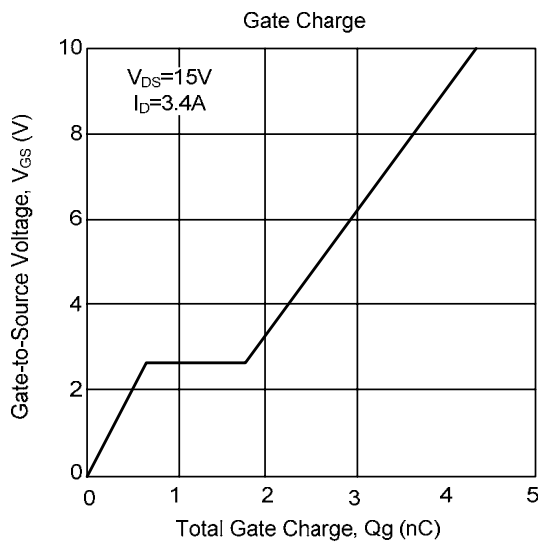
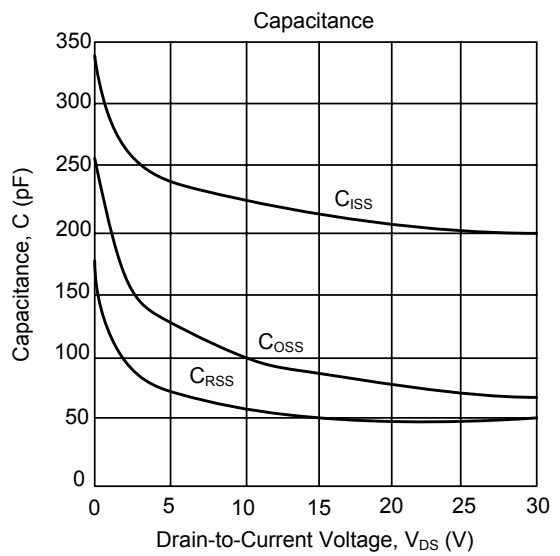
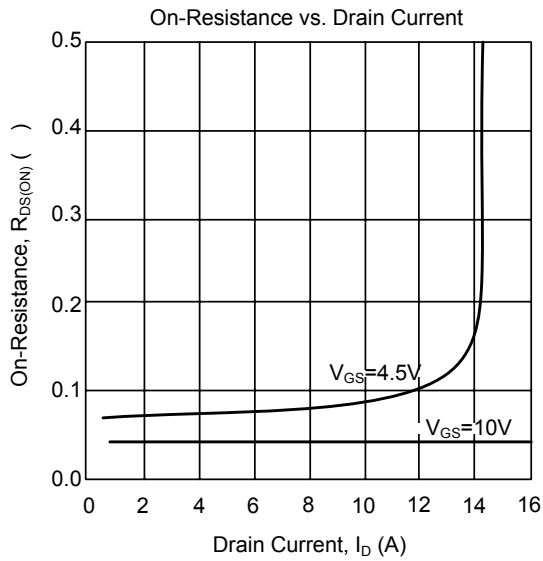
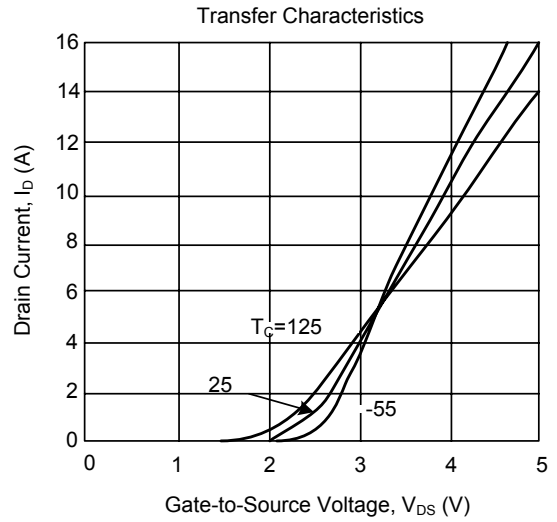
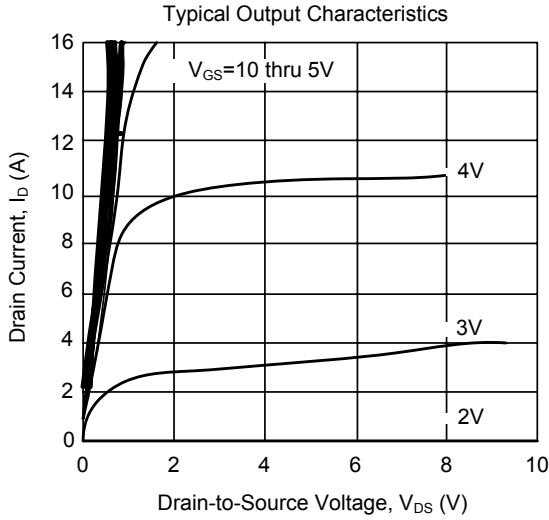

## ■ TYPICAL CHARACTERISTICS(Cont.)

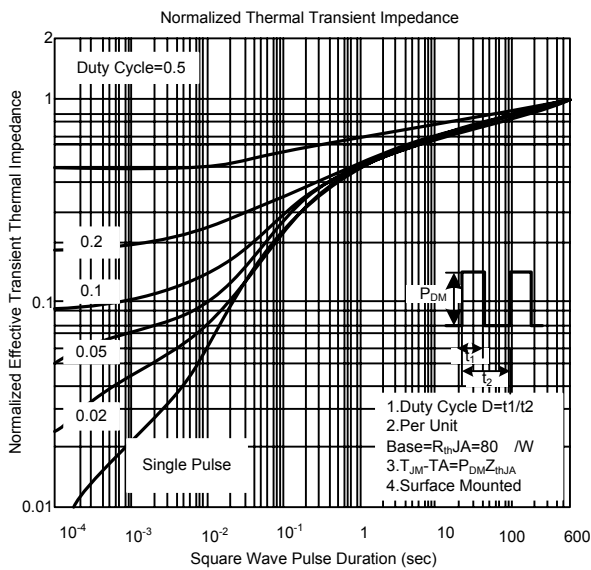
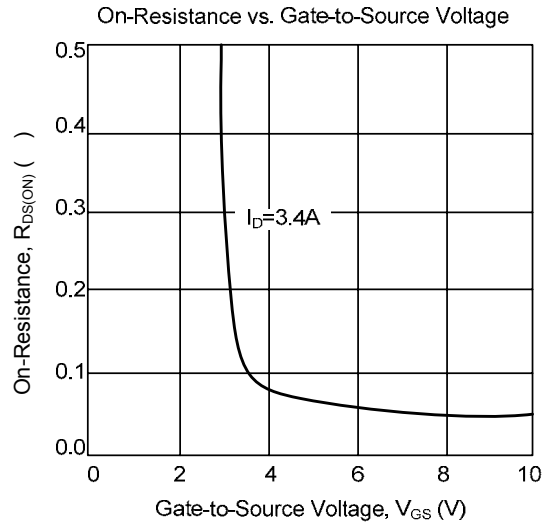
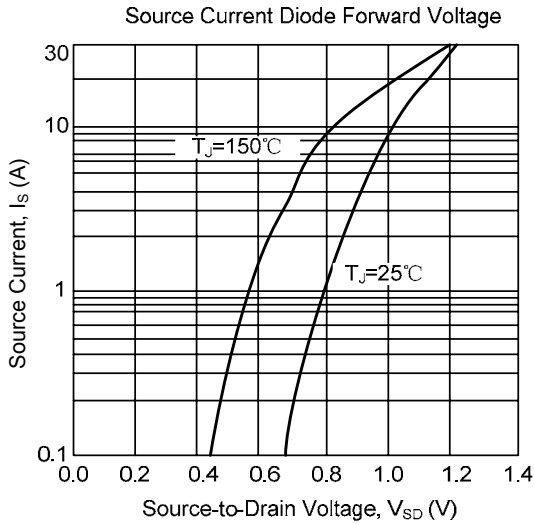

UTC assumes no responsibility for equipment failures that result from using products at values that exceed, even momentarily, rated values (such as maximum ratings, operating condition ranges, or other parameters) listed in products specifications of any and all UTC products described or contained herein. UTC products are not designed for use in life support appliances, devices or systems where malfunction of these products can be reasonably expected to result in personal injury. Reproduction in whole or in part is prohibited without the prior written consent of the copyright owner. The information presented in this document does not form part of any quotation or contract, is believed to be accurate and reliable and may be changed without notice.