



**P-Channel Enhancement-Mode Vertical DMOS FETs**

**Ordering Information**

BV <sub>DSS</sub> / BV <sub>DGS</sub>	R <sub>DS(ON)</sub> (max)	I <sub>D(ON)</sub> (min)	Order Number / Package	
			TO-39	TO-92
-60V	0.9Ω	-4A	VP2206N2	VP2206N3

†MIL visual screening available

**High Reliability Devices**

See pages 5-4 and 5-5 for MILITARY STANDARD Process Flows and Ordering Information.

**Features**

- Free from secondary breakdown
- Low power drive requirement
- Ease of paralleling
- Low C<sub>ISS</sub> and fast switching speeds
- Excellent thermal stability
- Integral Source-Drain diode
- High input impedance and high gain
- Complementary N- and P-channel devices

**Applications**

- Motor controls
- Converters
- Amplifiers
- Switches
- Power supply circuits
- Drivers (relays, hammers, solenoids, lamps, memories, displays, bipolar transistors, etc.)

**Absolute Maximum Ratings**

Drain-to-Source Voltage	BV <sub>DSS</sub>
Drain-to-Gate Voltage	BV <sub>DGS</sub>
Gate-to-Source Voltage	± 20V
Operating and Storage Temperature	-55°C to +150°C
Soldering Temperature*	300°C

\* Distance of 1.6 mm from case for 10 seconds.

**Advanced DMOS Technology**

These enhancement-mode (normally-off) transistors utilize a vertical DMOS structure and Supertex's well-proven silicon-gate manufacturing process. This combination produces devices with the power handling capabilities of bipolar transistors and with the high input impedance and positive temperature coefficient inherent in MOS devices. Characteristic of all MOS structures, these devices are free from thermal runaway and thermally-induced secondary breakdown.

Supertex's vertical DMOS FETs are ideally suited to a wide range of switching and amplifying applications where high breakdown voltage, high input impedance, low input capacitance, and fast switching speeds are desired.

**Package Options**

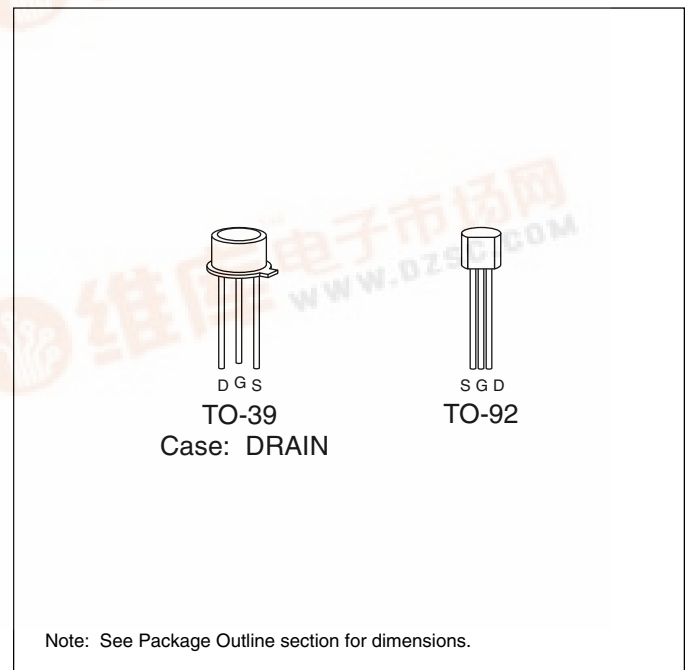

## Thermal Characteristics

Package	$I_D$ (continuous)*	$I_D$ (pulsed)	Power Dissipation @ $T_C = 25^\circ\text{C}$	$\theta_{jc}$ $^\circ\text{C/W}$	$\theta_{ja}$ $^\circ\text{C/W}$	$I_{DR}^*$	$I_{DRM}$
TO-39	-0.75A	-8.0A	6.0W	20.8	125	-0.75A	-8.0A
TO-92	-0.64A	-4.0A	1.0W	125	170	-0.64A	-4.0A

\*  $I_D$  (continuous) is limited by max rated  $T_J$ .

## Electrical Characteristics (@ $25^\circ\text{C}$ unless otherwise specified)

Symbol	Parameter	Min	Typ	Max	Unit	Conditions
$BV_{DSS}$	Drain-to-Source Breakdown Voltage	-60			V	$V_{GS} = 0V, I_D = -10mA$
$V_{GS(th)}$	Gate Threshold Voltage	-1.0		-3.5	V	$V_{GS} = V_{DS}, I_D = -10mA$
$\Delta V_{GS(th)}$	Change in $V_{GS(th)}$ with Temperature		-4.3	-5.5	mV/ $^\circ\text{C}$	$V_{GS} = V_{DS}, I_D = -10mA$
$I_{GSS}$	Gate Body Leakage		-1	-100	nA	$V_{GS} = \pm 20V, V_{DS} = 0V$
$I_{DSS}$	Zero Gate Voltage Drain Current			-50	$\mu\text{A}$	$V_{GS} = 0V, V_{DS} = \text{Max Rating}$
				-10	mA	$V_{GS} = 0V, V_{DS} = 0.8 \text{ Max Rating}$ $T_A = 125^\circ\text{C}$
$I_{D(ON)}$	ON-State Drain Current	-0.85	-2		A	$V_{GS} = -5V, V_{DS} = -25V$
		-4	-9			$V_{GS} = -10V, V_{DS} = -25V$
$R_{DS(ON)}$	Static Drain-to-Source ON-State Resistance		1.3	1.5	$\Omega$	$V_{GS} = -5V, I_D = -1A$
			0.75	0.9		$V_{GS} = -10V, I_D = -3.5A$
$\Delta R_{DS(ON)}$	Change in $R_{DS(ON)}$ with Temperature		0.85	1.2	%/ $^\circ\text{C}$	$V_{GS} = -10V, I_D = -3.5A$
$G_{FS}$	Forward Transconductance	0.8	1.4		$\text{S}$	$V_{DS} = -25V, I_D = -2A$
$C_{ISS}$	Input Capacitance		325	450	pF	$V_{GS} = 0V, V_{DS} = -25V$ $f = 1 \text{ MHz}$
$C_{OSS}$	Common Source Output Capacitance		125	180		
$C_{RSS}$	Reverse Transfer Capacitance		30	40		
$t_{d(ON)}$	Turn-ON Delay Time		4	15	ns	$V_{DD} = -25V$ $I_D = -4A$ $R_{GEN} = 10\Omega$
$t_r$	Rise Time		16	25		
$t_{d(OFF)}$	Turn-OFF Delay Time		16	50		
$t_f$	Fall Time		22	50		
$V_{SD}$	Diode Forward Voltage Drop		-1.1	-1.6	V	$V_{GS} = 0V, I_{SD} = -3.5A$
$t_{rr}$	Reverse Recovery Time		500		ns	$V_{GS} = 0V, I_{SD} = -1A$

Note 1: All D.C. parameters 100% tested at  $25^\circ\text{C}$  unless otherwise stated. (Pulse test:  $300\mu\text{s}$  pulse, 2% duty cycle.)

Note 2: All A.C. parameters sample tested.

## Switching Waveforms and Test Circuit

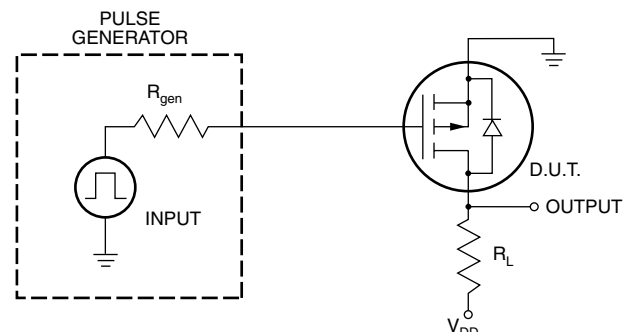
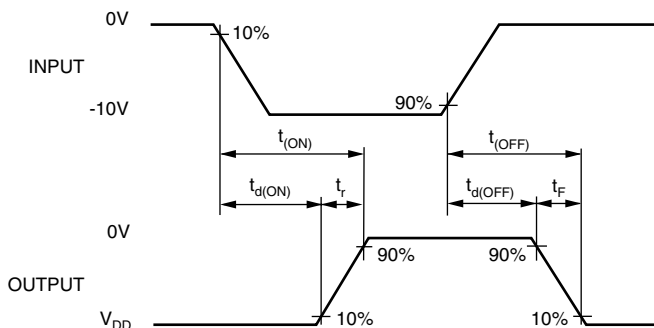

# Typical Performance Curves

Output Characteristics

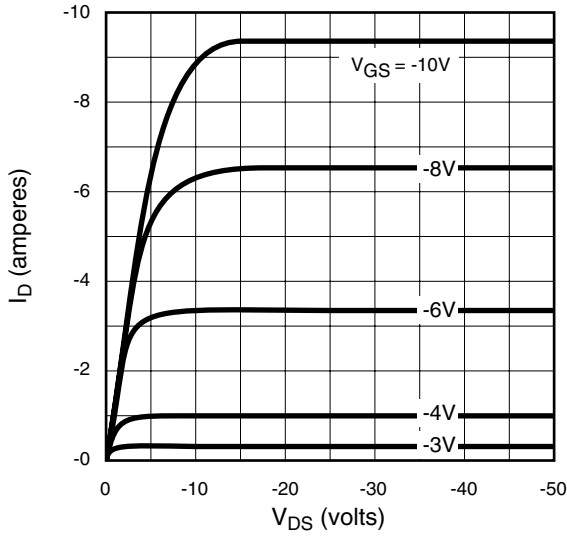

Saturation Characteristics

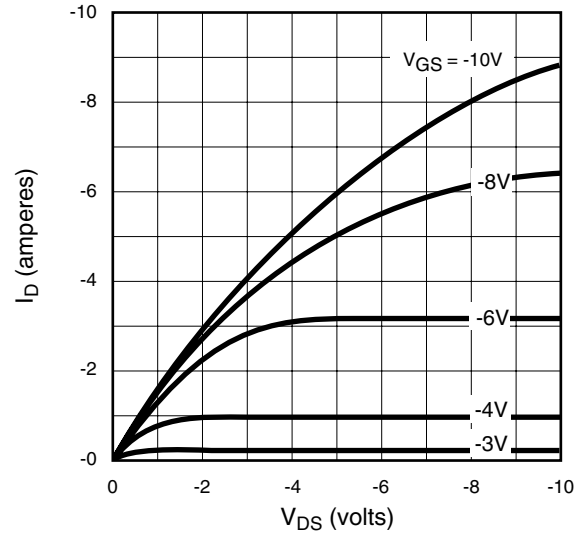

Transconductance vs. Drain Current

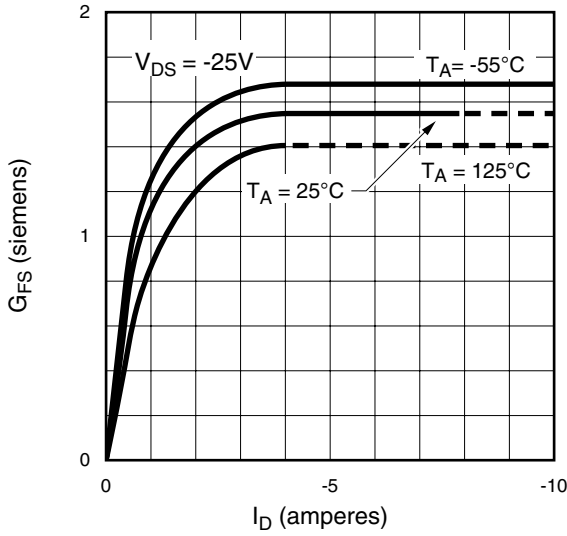

Power Dissipation vs. Case Temperature

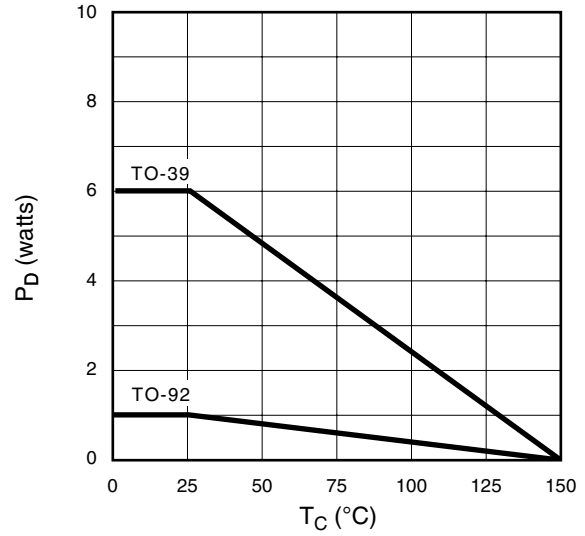

Maximum Rated Safe Operating Area

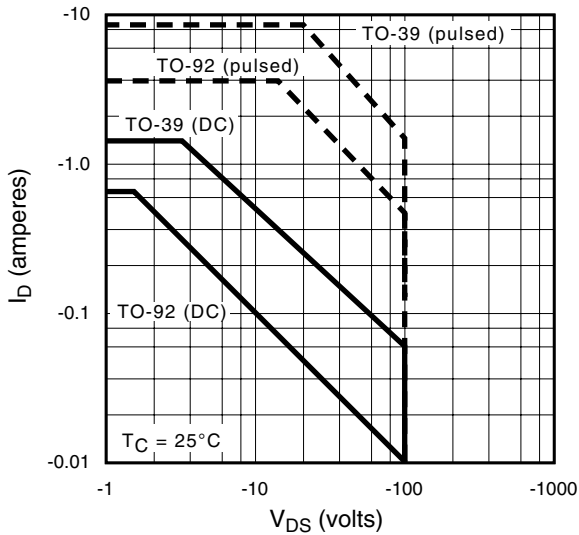

Thermal Response Characteristics

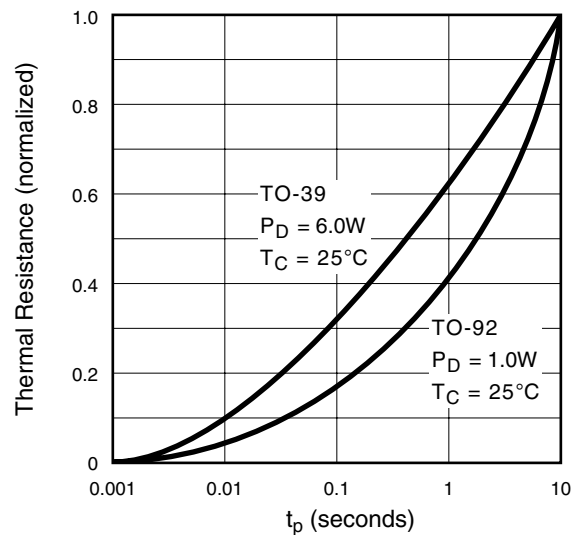

# Typical Performance Curves

BV<sub>DSS</sub> Variation with Temperature

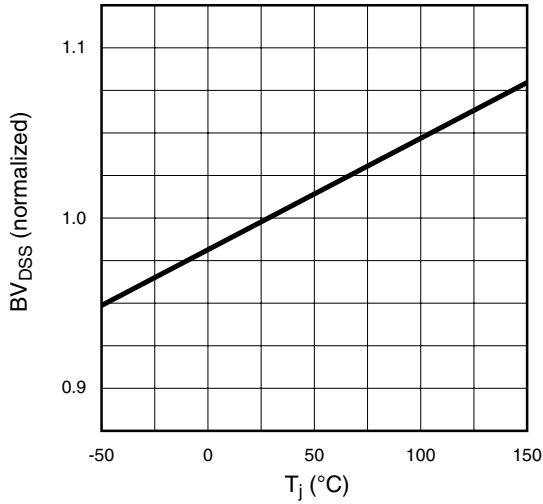

On-Resistance vs. Drain Current

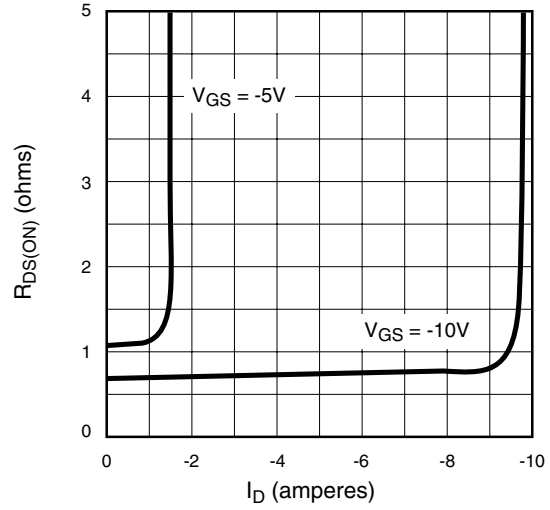

Transfer Characteristics

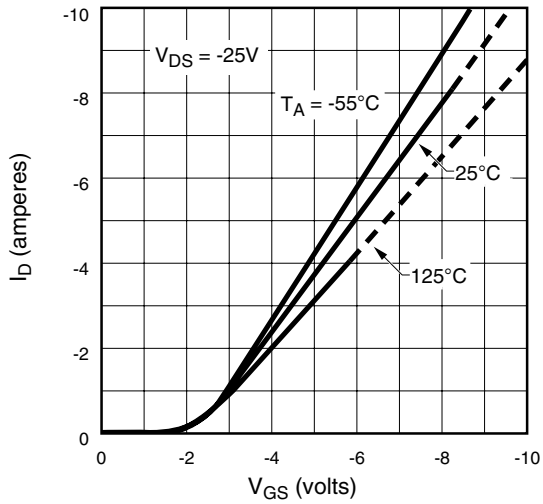

V<sub>(th)</sub> and R<sub>DS</sub> Variation with Temperature

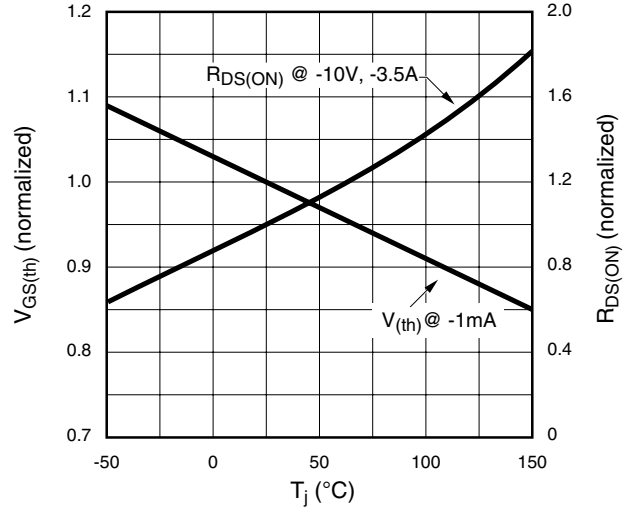

Capacitance vs. Drain-to-Source Voltage

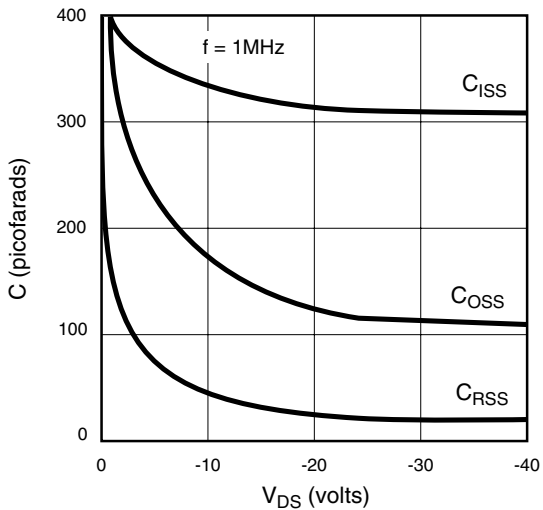

Gate Drive Dynamic Characteristics

