

Kingbright

T-1 3/4 (5mm) SOLID STATE LAMP

WP1513EC

HIGH EFFICIENCY RED

Features

- LOW POWER CONSUMPTION.
- VERSATILE MOUNTING ON P.C. BOARD OR PANEL.
- T-1 3/4 DIAMETER PACKAGE, TAPERED TYPE.
- RELIABLE AND RUGGED.
- RoHS COMPLIANT.

Description

The High Efficiency Red source color devices are made with Gallium Arsenide Phosphide on Gallium Phosphide Orange Light Emitting Diode.

Package Dimensions

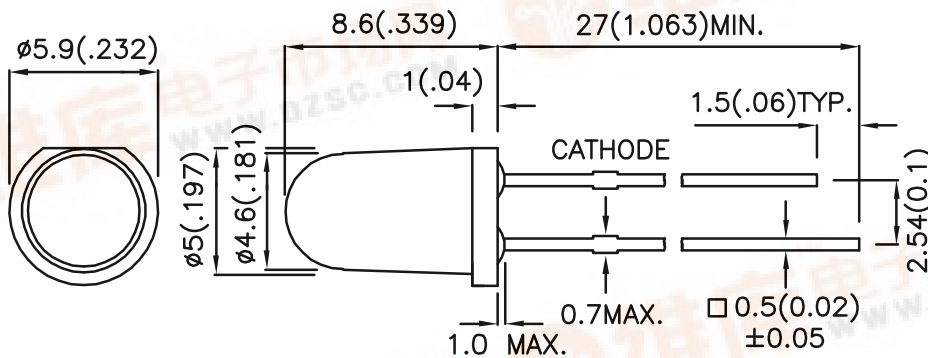

Notes:

1. All dimensions are in millimeters (inches).
2. Tolerance is $\pm 0.25 (0.01)$ unless otherwise noted.
3. Lead spacing is measured where the leads emerge from the package.
4. Specifications are subject to change without notice.

Selection Guide

Part No.	Dice	Lens Type	Iv (mcd) @ 10mA		Viewing Angle
			Min.	Typ.	2 θ 1/2
WP1513EC	HIGH EFFICIENCY RED(GaAsP/GaP)	WATER CLEAR	40	80	20°

Note:

1. θ1/2 is the angle from optical centerline where the luminous intensity is 1/2 the optical centerline value.

Electrical / Optical Characteristics at TA=25°C

Symbol	Parameter	Device	Typ.	Max.	Units	Test Conditions
λ _{peak}	Peak Wavelength	High Efficiency Red	627		nm	I _F =20mA
λ _D	Dominant Wavelength	High Efficiency Red	625		nm	I _F =20mA
Δλ _{1/2}	Spectral Line Half-width	High Efficiency Red	45		nm	I _F =20mA
C	Capacitance	High Efficiency Red	15		pF	V _F =0V;f=1MHz
V _F	Forward Voltage	High Efficiency Red	2.0	2.5	V	I _F =20mA
I _R	Reverse Current	High Efficiency Red		10	uA	V _R = 5V

Absolute Maximum Ratings at TA=25°C

Parameter	High Efficiency Red	Units
Power dissipation	105	mW
DC Forward Current	30	mA
Peak Forward Current [1]	160	mA
Reverse Voltage	5	V
Operating/Storage Temperature	-40°C To +85°C	
Lead Solder Temperature [2]	260°C For 3 Seconds	
Lead Solder Temperature [3]	260°C For 5 Seconds	

Notes:

1. 1/10 Duty Cycle, 0.1ms Pulse Width.
2. 2mm below package base.
3. 5mm below package base.

Kingbright

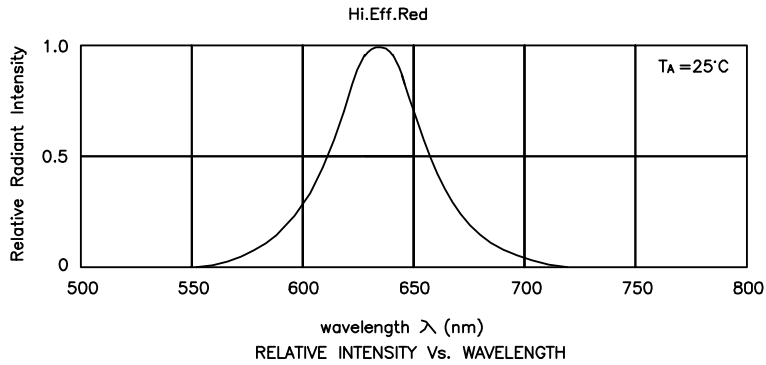

High Efficiency Red

WP1513EC

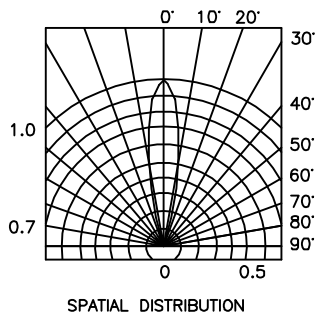
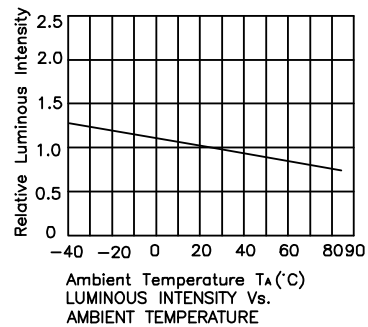
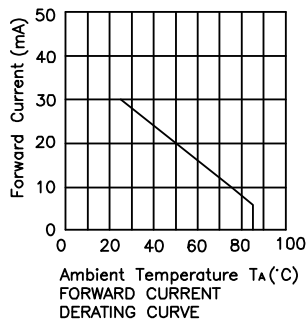
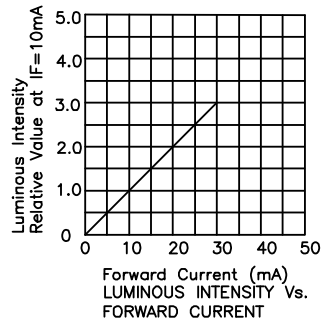
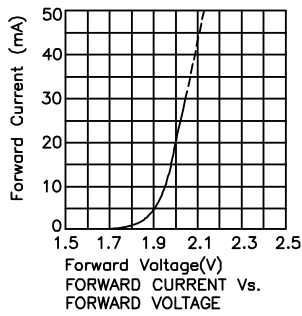

Kingbright

PACKING & LABEL SPECIFICATIONS

WP1513EC

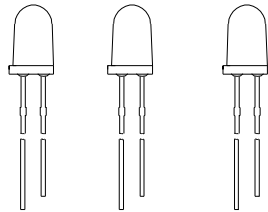

P/N: WP1513EC

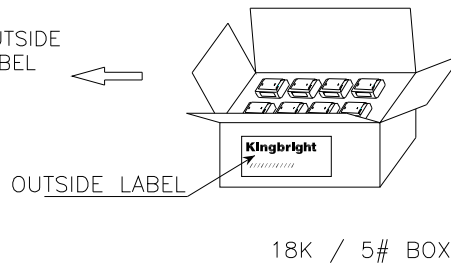
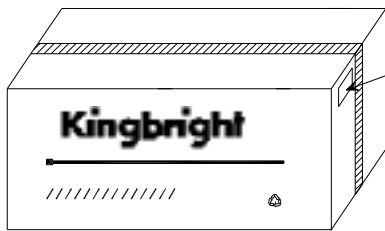
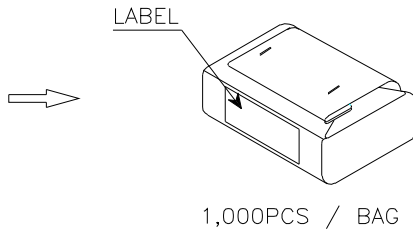

Kingbright				
Q.C.	<table border="1"> <tr> <td style="text-align: center;">QC</td> </tr> <tr> <td style="text-align: center;">xx xx xx</td> </tr> <tr> <td style="text-align: center;">PASSED</td> </tr> </table>	QC	xx xx xx	PASSED
QC				
xx xx xx				
PASSED				
TYPE NO : WP1513EC				
QUANTITY : 1,000 pcs				
S/N : XXX	CODE: XX			
LOT NO	 xxxxxxxxxx			
RoHS Compliant				

Remarks:

If special sorting is required (e.g. binning based on forward voltage, luminous intensity, or wavelength), the typical accuracy of the sorting process is as follows:

1. Wavelength: +/-1nm
2. Luminous Intensity: +/-15%
3. Forward Voltage: +/-0.1V

Note: Accuracy may depend on the sorting parameters.