

# Kingbright

## T-1 3/4 (5mm) SOLID STATE LAMP

WP1513GT

GREEN

### Features

- LOW POWER CONSUMPTION.
- VERSATILE MOUNTING ON P.C. BOARD OR PANEL.
- T-1 3/4 DIAMETER PACKAGE, TAPERED TYPE.
- RELIABLE AND RUGGED.
- RoHS COMPLIANT.

### Description

The Green source color devices are made with Gallium Phosphide Green Light Emitting Diode.

### Package Dimensions

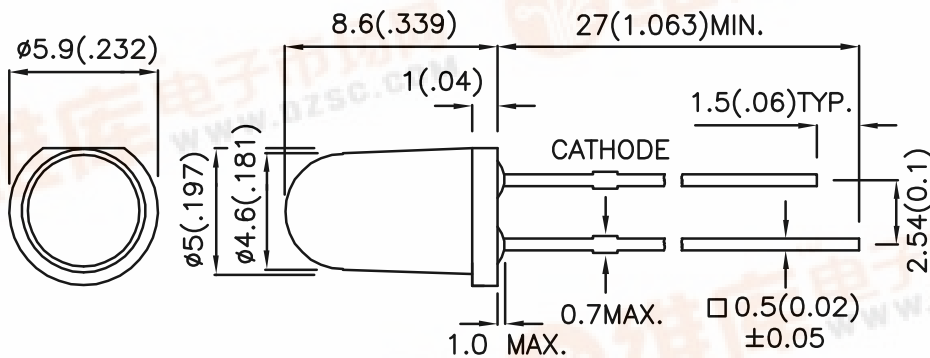

#### Notes:

1. All dimensions are in millimeters (inches).
2. Tolerance is  $\pm 0.25(0.01)$  unless otherwise noted.
3. Lead spacing is measured where the leads emerge from the package.
4. Specifications are subject to change without notice.



## Selection Guide

Part No.	Dice	Lens Type	Iv (mcd) @ 10mA		Viewing Angle
			Min.	Typ.	2 θ 1/2
WP1513GT	GREEN (GaP)	GREEN TRANSPARENT	18	50	20°

Note:

1. θ1/2 is the angle from optical centerline where the luminous intensity is 1/2 the optical centerline value.

## Electrical / Optical Characteristics at T<sub>A</sub>=25°C

Symbol	Parameter	Device	Typ.	Max.	Units	Test Conditions
λ <sub>peak</sub>	Peak Wavelength	Green	565		nm	I <sub>F</sub> =20mA
λ <sub>D</sub>	Dominant Wavelength	Green	568		nm	I <sub>F</sub> =20mA
Δλ <sub>1/2</sub>	Spectral Line Half-width	Green	30		nm	I <sub>F</sub> =20mA
C	Capacitance	Green	15		pF	V <sub>F</sub> =0V;f=1MHz
V <sub>F</sub>	Forward Voltage	Green	2.2	2.5	V	I <sub>F</sub> =20mA
I <sub>R</sub>	Reverse Current	Green		10	uA	V <sub>R</sub> = 5V

## Absolute Maximum Ratings at T<sub>A</sub>=25°C

Parameter	Green	Units
Power dissipation	105	mW
DC Forward Current	25	mA
Peak Forward Current [1]	140	mA
Reverse Voltage	5	V
Operating / Storage Temperature	-40°C To +85°C	
Lead Solder Temperature [2]	260°C For 3 Seconds	
Lead Solder Temperature [3]	260°C For 5 Seconds	

Notes:

1. 1/10 Duty Cycle, 0.1ms Pulse Width.
2. 2mm below package base.
3. 5mm below package base.

# Kingbright

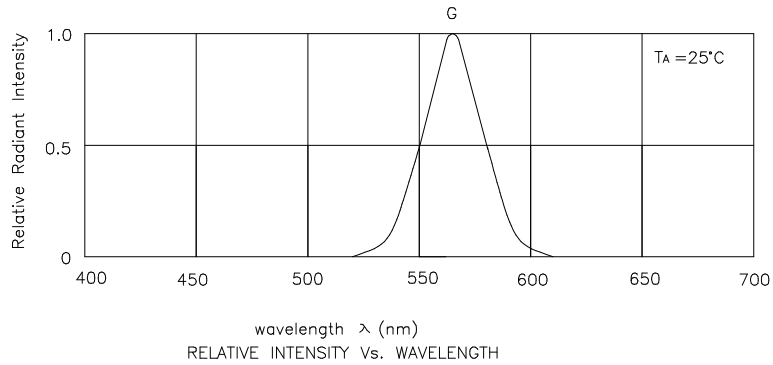

Green

WP1513GT

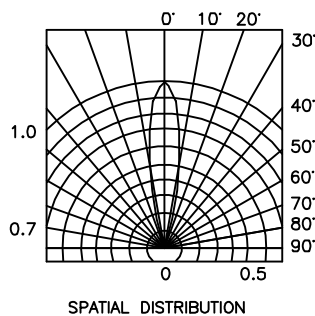
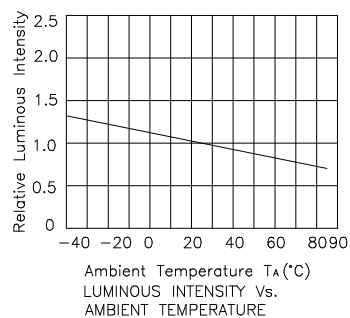
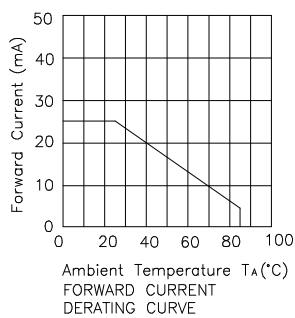
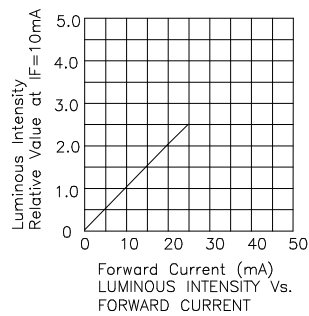
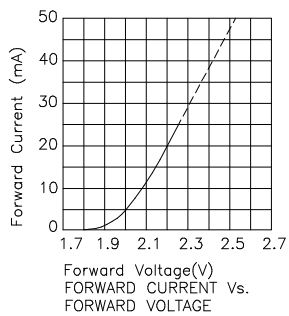

# Kingbright

## PACKING & LABEL SPECIFICATIONS

## WP1513GT

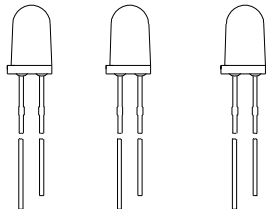

P/N: WP1513GT

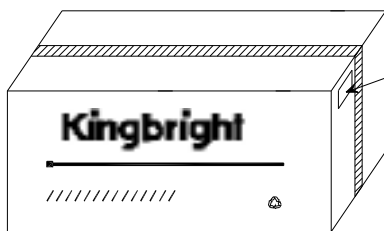
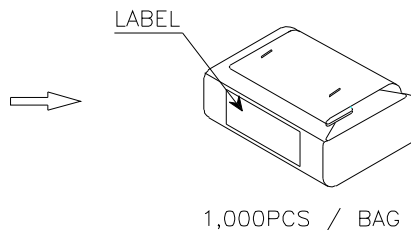

OUTSIDE LABEL

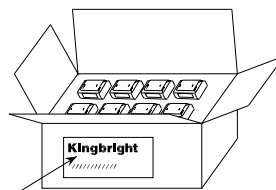

OUTSIDE LABEL

<b>Kingbright</b>				
Q.C.	<table border="1"> <tr> <td style="text-align: center;">QC</td> </tr> <tr> <td style="text-align: center;">xx xx xx</td> </tr> <tr> <td style="text-align: center;">PASSED</td> </tr> </table>	QC	xx xx xx	PASSED
QC				
xx xx xx				
PASSED				
TYPE NO : WP1513GT				
QUANTITY : 1,000 pcs				
S/N : xxx	CODE: XX			
LOT NO	 xxxxxxxxxx			
RoHS Compliant				

### Remarks:

If special sorting is required (e.g. binning based on forward voltage, luminous intensity, or wavelength), the typical accuracy of the sorting process is as follows:

1. Wavelength: +/-1nm
2. Luminous Intensity: +/-15%
3. Forward Voltage: +/-0.1V

Note: Accuracy may depend on the sorting parameters.