

[查询W83194BG-603供应商](#)

[捷多邦，专业PCB打样工厂，24小时加急出货](#)



**W83194BR-603**

**W83194BG-603**

# **Winbond Clock Generator For INTEL P4 Springdale Series Chipset**

Date: Mar/23/2006

Revision: 0.7



## W83194BR-603/W83194BG-603



### W83194BR-603/W83194BG-603 Data Sheet Revision History

	PAGES	DATES	VERSION	WEB VERSION	MAIN CONTENTS
1	n.a.			n.a.	All of the versions before 0.50 are for internal use.
2	n.a.	09/09/2003	0.5	n.a.	First published preliminary version.
3	6	09/17/2003	0.6	n.a.	Modify frequency table
4		03/23/2006	0.7	0.7	Add lead-free part number W83194BG-603
5					
6					
7					
8					
9					
10					

Please note that all data and specifications are subject to change without notice. All the trademarks of products and companies mentioned in this data sheet belong to their respective owners.

### LIFE SUPPORT APPLICATIONS

These products are not designed for use in life support appliances, devices, or systems where malfunction of these products can reasonably be expected to result in personal injury. Winbond customers using or selling these products for use in such applications do so at their own risk and agree to fully indemnify Winbond for any damages resulting from such improper use or sales.

# W83194BR-603/W83194BG-603



## CLOCK GEN. FOR INTEL P4 SPRINGDALE/PRESCOTT SERIES CHIPSET

### Table of Content-

1.	GENERAL DESCRIPTION .....	1
2.	PRODUCT FEATURES .....	1
3.	PIN CONFIGURATION .....	2
4.	BLOCK DIAGRAM .....	2
5.	PIN DESCRIPTION.....	3
5.1	Crystal I/O .....	3
5.2	CPU, SRC, 3V66 and PCI Clock Outputs.....	3
5.3	Fixed Frequency Outputs.....	4
5.4	I2C Control Interface .....	4
5.5	Power Management Pins.....	5
5.6	IREF selects Function .....	5
5.7	Power Pins.....	5
6.	FREQUENCY SELECTION BY HARDWARE OR SOFTWARE .....	6
7.	I2C CONTROL AND STATUS REGISTERS .....	7
7.1	Register 0: Frequency Select Register (Default = 10h) .....	7
7.2	Register 1: CPU Clock Register (1 = Enable, 0 = Stopped) (Default: E2h) .....	7
7.3	Register 2: PCI Clock Register (1 = Enable, 0 = Stopped) (Default: FFh).....	8
7.4	Register 3: PCI, 3V66 Clock Register (1 = Enable, 0 = Stopped) (Default: EFh).....	8
7.5	Register 4: 24_48MHz, 48MHz, REF, SRC Control Register (1 = Enable, 0 = Stopped) (Default: BFh).....	8
7.6	Register 5: Watchdog Control Register (Default: 02h).....	9
7.7	Register 6: Winbond Chip ID Register (Default: 60h) (Read Only) .....	9
7.8	Register 7: Winbond Chip ID Register (Default: 70h) (Read Only) .....	10
7.9	Register 8: M/N Program Register (Default: 90h) .....	10
7.10	Register 9: M/N Program Register (Default: 7Ah).....	10
7.11	Register 10: M/N Program Register (Default: BBh) .....	11
7.12	Register 11: Spread Spectrum Programming Register (Default: 0Bh) .....	11
7.13	Register 12: Divisor and Step-less Enable Control Register: (Default: FBh).....	12
7.14	Register 13: Divisor and Step-less Enable Control Register (Default: 0Fh) .....	12
7.15	Register 14: Control Register (Default: 0Ah).....	13
7.16	Register 15: Control Register (Default: 2Ch).....	13
7.17	Register 16: Control Register (Default: 24h) .....	14
7.18	Register 17: Slew rate Control Register (Default: 00h).....	14
7.19	Register 18: Slew rate Control Register (Default: 00h).....	14
7.20	Register 19: Control Register (Default: D2h).....	15
7.21	Register 20: Watch dog timer Register (Default: 88h) .....	15

# W83194BR-603/W83194BG-603



## CLOCK GEN. FOR INTEL P4 SPRINGDALE/PRESCOTT SERIES CHIPSET

7.22	Register21: Control Register (Default: 00h) .....	15
8.	ACCESS INTERFACE .....	16
8.1	Block Write protocol .....	16
8.2	Block Read protocol .....	16
8.3	Byte Write protocol .....	16
8.4	Byte Read protocol .....	16
9.	SPECIFICATIONS .....	17
9.1	ABSOLUTE MAXIMUM RATINGS .....	17
9.2	General Operating Characteristics .....	17
9.3	Skew Group timing clock .....	17
9.4	CPU 0.7V Electrical Characteristics .....	18
9.5	3V66 Electrical Characteristics .....	18
9.6	PCI Electrical Characteristics .....	18
9.7	24M, 48M Electrical Characteristics .....	19
9.8	REF Electrical Characteristics .....	19
10.	ORDERING INFORMATION .....	19
11.	HOW TO READ THE TOP MARKING .....	20
12.	PACKAGE DRAWING AND DIMENSIONS .....	21

# W83194BR-603/W83194BG-603



## 1. GENERAL DESCRIPTION

The W83194BR-603 is a Clock Synthesizer for Intel Springdale/Prescott chipset. W83194BR-603 provides all clocks required for high-speed microprocessor and provides step-less frequency programming and 32 different frequencies of CPU, PCI, and 3V66 clocks setting, support SRC clock outputs, all clocks are externally selectable with smooth transitions.

The W83194BR-603 provides I<sup>2</sup>C serial bus interface to program the registers to enable or disable each clock outputs and provides -0.5% and +/-0.25% center type spread spectrum or programmable S.S.T. scale to reduce EMI.

The W83194BR-603 also has watchdog timer and reset output pin to support auto-reset when systems hanging caused by improper frequency setting.

The W83194BR-603 accepts a 14.318 MHz reference crystal as its input and runs on a 3.3V supply.

## 2. PRODUCT FEATURES

- 2 0.7V current-mode Differential pairs clock outputs for CPU
- 1 0.7V current-mode Differential pairs clock outputs for SRC
- 3 3V66 clock outputs
- 1 VCH/3V66 selectable 48MHz or 66MHz
- 9 PCI synchronous clocks
- 1 24\_48Mhz clock output for super I/O.
- 1 48 MHz clock output for USB.
- 2 14.318MHz REF clock outputs.
- 3V66/PCI clock out supports synchronous and asynchronous mode
- Smooth frequency switch with selections from 100 to 400MHz
- Step-less frequency programming
- I<sup>2</sup>C 2-Wire serial interface and support byte read/write and block read/write.
- -0.5% and +/- 0.25% center type spread spectrum
- Programmable S.S.T. scale to reduce EMI
- Programmable registers to enable/stop each output and select modes
- Programmable clock outputs Slew rate control and Skew control
- Watch Dog Timer and RESET# output pins
- 48-pin SSOP package

# W83194BR-603/W83194BG-603



## 3. PIN CONFIGURATION

FS1*/REF0	1	48	VDDA
FS0*/REF1	2	47	GND
VDDREF	3	46	IREF
XIN	4	45	CPUT_ITP
XOUT	5	44	CPUC_ITP
GND	6	43	GND
FS2*/PCL_F0	7	42	CPUT1
FS4*/PCL_F1	8	41	CPUC1
PCL_F2	9	40	VDDCPU
VDDPCI	10	39	CPUT0
GND	11	38	CPUC0
MODE*/PCI0	12	37	GND
PCI1	13	36	SRCT
PCI2	14	35	SRCC
PCI3	15	34	VDD
VDDPCI	16	33	VTT_PWRGD#
GND	17	32	SDATA*
PCI4	18	31	SCLK*
PCI5	19	30	3V66_0/RESET#
PD#	20	29	3V66_1
SEL24_48# &/24_48MHz	21	28	GND
FS3*/48MHz	22	27	VDD3V66
GND	23	26	3V66_2
VDD48	24	25	3V66_3/VCH

#: Active low  
 \*: Internal pull up resistor 120K to VDD  
 &: Internal Pull-down resistor 120K to GND

## 4. BLOCK DIAGRAM

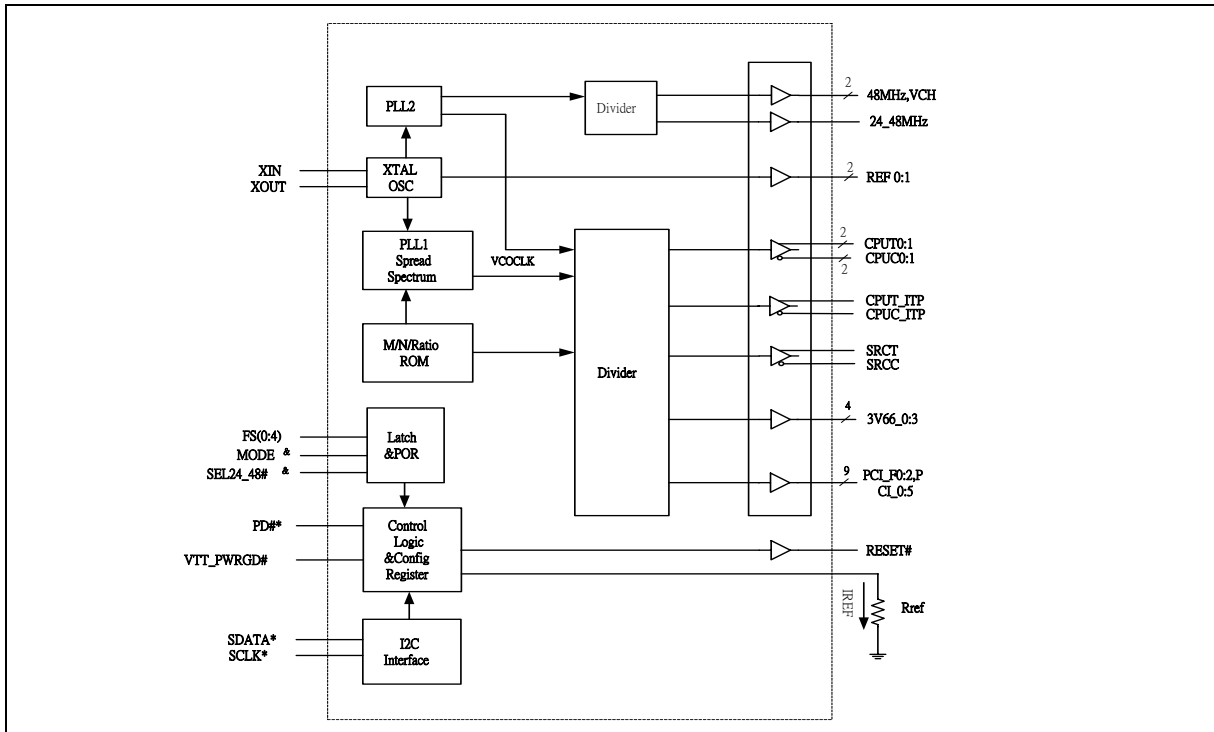

## W83194BR-603/W83194BG-603



### 5. PIN DESCRIPTION

BUFFER TYPE SYMBOL	DESCRIPTION
IN	Input
IN <sub>tp120k</sub>	Latched input at power up, internal 120kΩ pull up.
IN <sub>td120k</sub>	Latched input at power up, internal 120kΩ pull down.
OUT	Output
OD	Open Drain
I/OD	Bi-directional Pin, Open Drain.
#	Active Low
*	Internal 120kΩ pull-up
&	Internal 120 kΩ pull-down

#### 5.1 Crystal I/O

PIN	PIN NAME	TYPE	DESCRIPTION
4	XIN	IN	Crystal input with internal loading capacitors (18pF) and feedback resistors.
5	XOUT	OUT	Crystal output at 14.318MHz nominally with internal loading capacitors (18pF).

#### 5.2 CPU, SRC, 3V66 and PCI Clock Outputs

PIN	PIN NAME	TYPE	DESCRIPTION
42,39,41,38	CPUT [0:1] CPUC [0:1]	OUT	Low skew (< 250ps) differential clock outputs for host frequencies of CPU
45,44	CPUT_ITP CPUC_ITP	OUT	Differential clock outputs for host frequencies of CPU
36,35	SRCT, SRCC	OUT	Differential clock outputs 100MHz/200MHz Select by for SRC
30	3V66_0	OUT	3.3V 66MHz clock output (Default). Selected by MODE latch input =0.
	RESET#	OD	System reset signal when the watchdog is time out. This pin will generate 250ms low phase when the watchdog timer is timeout. Selected by MODE latch input =1.
29,26	3V66_1:2	OUT	3.3V 66MHz clock outputs.
25	3V66_3	OUT	3.3V 66MHz clock output (Default), Selected by Register byte 3 bit 4 =0.
	VCH_CLK	OUT	3.3V 48MHz clock output, Selected by Register byte 3 bit 4 =1.
7	PCI_F0	OUT	3.3V PCI free running clock output.
	FS2 <sup>&amp;</sup>	IN <sub>td120k</sub>	Latched input for FS2 at initial power up for H/W selecting the output frequency. This is internal 120K pull down.

## W83194BR-603/W83194BG-603



CPU, SRC, 3V66 and PCI Clock Outputs, continued

PIN	PIN NAME	TYPE	DESCRIPTION
8	PCI_F1	OUT	3.3V PCI free running clock output.
	FS4 <sup>&amp;</sup>	IN <sub>td120k</sub>	Latched input for FS4 at initial power up for H/W selecting the output frequency, This is internal 120K pull down.
9	PCI_F2	OUT	3.3V PCI free running clock output.
12	PCI0	OUT	3.3V PCI clock output.
	MODE <sup>&amp;</sup>	IN <sub>td120k</sub>	Latched input for pin 30 at initial power up selecting the 0=3V66 clock output, 1=RESET# control pin. This is internal 120K $\Omega$ pull down.
13,14,15,18,19	PCI [1:5]	OUT	Low skew (< 250ps) 3.3V PCI clock outputs.

### 5.3 Fixed Frequency Outputs

PIN	PIN NAME	TYPE	DESCRIPTION
1	REF0	OUT	14.318MHz output.
	FS1 <sup>*</sup>	IN <sub>tp120k</sub>	Latched input for FS1 at initial power up for H/W selecting the output frequency. This is internal 120K pull up.
2	REF1	OUT	14.318MHz output.
	FS0 <sup>&amp;</sup>	IN <sub>td120k</sub>	Latched input for FS0 at initial power up for H/W selecting the output frequency. This is internal 120K pull down.
22	48MHz	OUT	48MHz clock output for USB.
	FS3 <sup>&amp;</sup>	IN <sub>td120k</sub>	Latched input for FS3 at initial power up for H/W selecting the output frequency. This is internal 120K pull down.
21	24_48MHz	OUT	24MHz or 48MHz(default) clock output, In power on reset period, it is a hardware-latched pin, and it can be R/W by I2C control after power on reset period. Select by register 5 bit 7.
	SEL24_48# <sup>&amp;</sup>	IN <sub>td120k</sub>	Latched input for 24MHz or 48MHz select pin. This is internal 120K pull down default 48MHz. In power on reset period, it is a hardware-latched pin, and it can be R/W by I2C control after power on reset period. Select by register 5 bit 7.

### 5.4 I2C Control Interface

PIN	PIN NAME	TYPE	DESCRIPTION
32	SDATA <sup>*</sup>	I/OD	Serial data of I <sup>2</sup> C 2-wire control interface with internal pull-up resistor.
31	SCLK <sup>*</sup>	IN	Serial clock of I <sup>2</sup> C 2-wire control interface with internal pull-up resistor.



## W83194BR-603/W83194BG-603



### 5.5 Power Management Pins

PIN	PIN NAME	TYPE	DESCRIPTION
33	VTT_PWRGD#	IN	Power good input signal is power on trapping with LOW active. This 3.3V input is level sensitive strobe used to determine FS [4:0]. This pin is LOW active.
20	PD#*	IN <sub>tp120k</sub>	Power Down Function. This is power down pin, low active (PD#). Internal 120K pull up
46	IREF	OUT	Deciding the reference current for the CPU CLOCK pairs. The pin was connected to the precision resistor tied to ground to decide the appropriate current.

### 5.6 IREF selects Function

BOARD TARGET TRACE/TERM Z	REFERENCE R, IREF = ADD/(3*RR)	OUTPUT CURRENT	VOH @ Z
50 Ω	Rr =221 1% IREF = 5.00mA	Ioh=4*IREF	1.0V @ 50
50 Ω	Rr =475 1% IREF = 2.32mA	Ioh=6*IREF	0.7V @ 50

### 5.7 Power Pins

PIN	PIN NAME	TYPE	DESCRIPTION
3	VDDREF	PWR	3.3V power supply for REF.
10,16	VDDPCI	PWR	3.3V power supply for PCI.
27	VDD3V66	PWR	3.3V power supply for 3V66.
40	VDDCPU	PWR	3.3V power supply for CPU.
24	VDD48	PWR	3.3 power supply for 48MHz.
34	VDD	PWR	3.3V power supply for SRC.
48	VDDA	PWR	3.3V power for Analog power
7,12,19,25,29,38,44,47	GND	PWR	Ground pin

## W83194BR-603/W83194BG-603



### 6. FREQUENCY SELECTION BY HARDWARE OR SOFTWARE

This frequency table is used at power on latched FS [4:0] value or software programming at SSEL [4:0] (Register 0 bit 7 ~ 3), **mark – is reserved.**

FS4	FS3	FS2	FS1	FS0	CPU (MHZ)	3V66 (MHZ)	PCI (MHZ)
0	0	0	0	0	100.00	66.67	33.33
0	0	0	0	1	200.01	66.67	33.33
0	0	0	1	0	133.34	66.67	33.33
0	0	0	1	1	-	-	-
0	0	1	0	0	200.01	66.67	33.33
0	0	1	0	1	400.01	66.67	33.33
0	0	1	1	0	266.68	66.67	33.33
0	0	1	1	1	-	-	-
0	1	0	0	0	101.1	67.34	33.67
0	1	0	0	1	202.2	67.34	33.67
0	1	0	1	0	134.68	67.34	33.67
0	1	0	1	1	-	-	-
0	1	1	0	0	-	-	-
0	1	1	0	1	-	-	-
0	1	1	1	0	-	-	-
0	1	1	1	1	-	-	-
1	0	0	0	0	100.00	66.67	33.33
1	0	0	0	1	200.01	66.67	33.33
1	0	0	1	0	133.34	66.67	33.33
1	0	0	1	1	-	-	-
1	0	1	0	0	200.01	66.67	33.33
1	0	1	0	1	400.01	66.67	33.33
1	0	1	1	0	266.68	66.67	33.33
1	0	1	1	1	-	-	-
1	1	0	0	0	105.04	70.02	35.01
1	1	0	0	1	210.07	70.02	35.01
1	1	0	1	0	140.05	70.02	35.01
1	1	0	1	1	-	-	-
1	1	1	0	0	-	-	-
1	1	1	0	1	-	-	-
1	1	1	1	0	-	-	-
1	1	1	1	1	-	-	-

## W83194BR-603/W83194BG-603



### 7. I2C CONTROL AND STATUS REGISTERS

#### 7.1 Register 0: Frequency Select Register (Default = 10h)

BIT	NAME	PWD	DESCRIPTION
7	SSEL [4]	0	Frequency selection by software via I <sup>2</sup> C
6	SSEL [3]	0	
5	SSEL [2]	0	
4	SSEL [1]	1	
3	SSEL [0]	0	
2	EN_SSEL	0	Enable software program FS [4:0]. 0 = Select frequency by hardware. 1 = Select frequency by software I <sup>2</sup> C - Bit 7~ 3.
1	EN_SPSP	0	Enable Spread Spectrum in the frequency table. 0 = Normal 1 = Spread Spectrum enabled
0	EN_SAFE_FREQ	0	Enable reload safe frequency when the watchdog is timeout. 0 = reload the FS [4:0] latched pins when watchdog time out. 1 = reload the safe frequency bit defined at Register 5 bit 4~0.

#### 7.2 Register 1: CPU Clock Register (1 = Enable, 0 = Stopped) (Default: E2h)

BIT	PIN NO	PWD	DESCRIPTION
7	45,44	1	CPUT/C_ITP output control.
6	42,41	1	CPUT1 / C1 output control.
5	39,38	1	CPUT0 / C0 output control.
4	-	X	Power on latched value of FS4 pin. Default: 0. (Read Only).
3	-	X	Power on latched value of FS3 pin. Default: 0. (Read Only).
2	-	X	Power on latched value of FS2 pin. Default: 0. (Read Only).
1	-	X	Power on latched value of FS1 pin. Default: 1. (Read Only).
0	-	X	Power on latched value of FS0 pin. Default: 0. (Read Only).

## W83194BR-603/W83194BG-603



### 7.3 Register 2: PCI Clock Register (1 = Enable, 0 = Stopped) (Default: FFh)

BIT	PIN NO	PWD	DESCRIPTION
7	9	1	PCI_F2 output control.
6	8	1	PCI_F1 output control.
5	7	1	PCI_F0 output control.
4	-	1	Reserved
3	-	1	Reserved
2	19	1	PCI5 output control.
1	18	1	PCI4 output control.
0	15	1	PCI3 output control.

### 7.4 Register 3: PCI, 3V66 Clock Register (1 = Enable, 0 = Stopped) (Default: EFh)

BIT	PIN NO	PWD	DESCRIPTION
7	14	1	PCI2 output control.
6	13	1	PCI1 output control.
5	12	1	PCI0 output control.
4	-	0	3V66_3 / VCH output select 1: VCH output, 0: 3V66 output (Default)
3	25	1	3V66_3 / VCH output control.
2	26	1	3V66_2 output control.
1	29	1	3V66_1 output control.
0	30	1	3V66_0 output control.

### 7.5 Register 4: 24\_48MHz, 48MHz, REF, SRC Control Register (1 = Enable, 0 = Stopped) (Default: BFh)

BIT	PIN NO	PWD	DESCRIPTION
7	21	1	24_48MHz output control.
6	-	0	Reserved
5	22	1	48MHz output control.
4	-	1	Reserved
3	2	1	REF1 output control.
2	1	1	REF0 output control.
1	35,36	1	SRCT/C output control.
0	-	1	Reserved

## W83194BR-603/W83194BG-603



### 7.6 Register 5: Watchdog Control Register (Default: 02h)

BIT	NAME	PWD	DESCRIPTION
7	SEL24_48	X	24 / 48 MHz output selection, 1: 24 MHz.0: 48 MHz. (Default) Default value follow hardware trapping data on SEL24_48# pin.
6	EN_WD	0	Program this bit => 1: Enable Watchdog Timer feature. 0: Disable Watchdog Timer feature. Read-back this bit => During timer count down the bit read back to 1. If count to zero, this bit read back to 0.
5	WD_TIMEOUT	0	Read Back only. Timeout Flag. This bit is Read Only. 1: Watchdog has ever started and counts to zero. 0: Watchdog is restarted and counting.
4	SAF_FREQ [4]	0	These bits will be reloaded in Reg-0 to select frequency table. As the watchdog is timeout and EN_SAFE_FREQ=1.
3	SAF_FREQ [3]	0	
2	SAF_FREQ [2]	0	
1	SAF_FREQ [1]	1	
0	SAF_FREQ [0]	0	

### 7.7 Register 6: Winbond Chip ID Register (Default: 60h) (Read Only)

BIT	NAME	PWD	DESCRIPTION
7	MAS_ID [1]	0	MASK definition for master body *A****: 01, *B****: 10, *C****: 11, *D****: 00
6	MAS_ID [0]	1	
5	SUB_ID [1]	1	MASK definition for code body *A****001: 01, *A****002: 10, *A****003: 11, *A****004: 00
4	SUB_ID [0]	0	
3	MAS_VER_ID [1]	0	MASK version definition for master body *A****001A: 00, *A****001B: 01, *A****001C: 10, *A****001D: 11.
2	MAS_VER_ID [0]	0	
1	SUB_VER_ID [1]	0	MASK version definition for code body *A****001A: 00, *A****001B: 01 *A****001C: 10, *A****001D: 11
0	SUB_VER_ID [0]	0	

## W83194BR-603/W83194BG-603



### 7.8 Register 7: Winbond Chip ID Register (Default: 70h) (Read Only)

BIT	NAME	PWD	DESCRIPTION
7	CHPI_ID [7]	0	Winbond Chip ID. W83194BR-603 (SA5870)
6	CHPI_ID [6]	1	Winbond Chip ID.
5	CHPI_ID [5]	1	Winbond Chip ID.
4	CHPI_ID [4]	1	Winbond Chip ID.
3	CHPI_ID [3]	0	Winbond Chip ID.
2	CHPI_ID [2]	0	Winbond Chip ID.
1	CHPI_ID [1]	0	Winbond Chip ID.
0	CHPI_ID [0]	0	Winbond Chip ID.

### 7.9 Register 8: M/N Program Register (Default: 90h)

BIT	NAME	PWD	DESCRIPTION
7	N_DIV [8]	1	Programmable N divisor value. Bit 7 ~0 are defined in the Register 9.
6	M_DIV [6]	0	Programmable M divisor value.
5	M_DIV [5]	0	
4	M_DIV [4]	1	
3	M_DIV [3]	0	
2	M_DIV [2]	0	
1	M_DIV [1]	0	
0	M_DIV [0]	0	

### 7.10 Register 9: M/N Program Register (Default: 7Ah)

BIT	NAME	PWD	DESCRIPTION
7	N_DIV [7]	0	Programmable N divisor value bit 7 ~0. The bit 8 is defined in Register 8.
6	N_DIV [6]	1	
5	N_DIV [5]	1	
4	N_DIV [4]	1	
3	N_DIV [3]	1	
2	N_DIV [2]	0	
1	N_DIV [1]	1	
0	N_DIV [0]	0	

## W83194BR-603/W83194BG-603



CLOCK GEN. FOR INTEL P4 SPRINGDALE/PRESCOTT SERIES CHIPSET

### 7.11 Register 10: M/N Program Register (Default: BBh)

BIT	NAME	PWD	DESCRIPTION
7	N_DIV [9]	1	Programmable N divisor bit 9.
6	N3<6>	0	Programmable N3 divisor bit 6 ~0 for programmable SRC clocks. Frequency range: 86.8M ~ 115.2M Resolution: 224K
5	N3<5>	1	
4	N3<4>	1	
3	N3<3>	1	
2	N3<2>	0	
1	N3<1>	1	
0	N3<0>	1	

### 7.12 Register 11: Spread Spectrum Programming Register (Default: 0Bh)

BIT	NAME	PWD	DESCRIPTION
7	SP_UP [3]	0	Spread Spectrum Up Counter bit 3 ~ bit 0.
6	SP_UP [2]	0	
5	SP_UP [1]	0	
4	SP_UP [0]	0	
3	SP_DOWN [3]	1	Spread Spectrum Down Counter bit 3 ~ bit 0 2's complement representation. Ex: 1 -> 1111; 2 -> 1110; 7 -> 1001; 8 -> 1000
2	SP_DOWN [2]	0	
1	SP_DOWN [1]	1	
0	SP_DOWN [0]	1	

## W83194BR-603/W83194BG-603



### 7.13 Register 12: Divisor and Step-less Enable Control Register: (Default: FBh)

BIT	NAME	PWD	DESCRIPTION
7	Reserved	1	Reserved
6	DS9	1	Define the 3V66 divider ratio Table-2 integrate the all divider configuration
5	DS5	1	
4	Reserved	1	Reserved
3	Reserved	1	
2	DS2	0	Define the CPU divider ratio
1	DS1	1	Refer to Table-2
0	DS0	1	

Table-2 CPU, 3V66 divider ratio selection Table

		LSB		CPU				
		3V66		Bit1, 0				
		Bit5		Bit1, 0				
		0	1	00	01	10	11	
MSB	Bit2/ Bit9	0	Div6	Div7	Div2	Div3	Div4	Div6
	1	Div10	Div12	Div8	Div8	Div8	Div8	

### 7.14 Register 13: Divisor and Step-less Enable Control Register (Default: 0Fh)

BIT	NAME	PWD	DESCRIPTION
7	EN_MN_PROG	0	0: Output frequency depend on frequency table 1: Program all clock frequency by changing M/N value The equation is <b><math>VCO = 14.318MHz * (N+4) / M</math></b> Once the watchdog timer timeout, the bit will be clear. Then the frequency will be decided by hardware default FS<4:0> or desired frequency select SAF_FREQ [4:0] depend on EN_SAFE_FREQ (Reg0 - bit 0).
6	Reserved	0	Reserved
5	Reserved	0	Reserved
4	Reserved	0	Reserved
3	IVAL<3>	1	Charge pump current selection
2	IVAL<2>	1	
1	IVAL<1>	1	
0	IVAL<0>	1	



## W83194BR-603/W83194BG-603



### 7.15 Register 14: Control Register (Default: 0Ah)

BIT	NAME	PWD	DESCRIPTION
7	CPUT_DRI	0	CPUT output state in during POWER DOWN or Stop mode assertion. 1: Driven (2*Iref) 0: Tristate (Floating) CPUC always tri-state (floating) in power down Assertion.
6	SRCT_DRI	0	SRC_T output state in during POWER DOWN or Stop mode assertion. 1: Driven (6*Iref => STOP mode) (2*Iref => POWER DOWN) 0: Tristate (Floating) SRC_C always tri-state (floating) in power down Assertion.
5	SPCNT [5]	0	Spread Spectrum Programmable time, the resolution is 280ns. Default period is 11.8us
4	SPCNT [4]	0	
3	SPCNT [3]	1	
2	SPCNT [2]	0	
1	SPCNT [1]	1	
0	SPCNT [0]	0	

### 7.16 Register 15: Control Register (Default: 2Ch)

BIT	NAME	PWD	DESCRIPTION
7	INV_CPU	0	Invert the CPU phase, 0: Default, 1: Inverse
6	Reserved	0	Reserved
5	SPSP_TYPE	1	Spread spectrum implementation method 1: Pendulum type, 0: Original
4	SPSP1	0	Spread Spectrum type select.
3	SPSP0	1	00: Down 1% 01: Down 0.5% 10: Center +/- 0.5% 11: Center +/- 0.25%
2	ASKEW [2]	1	CPU to 3V66 skew control, Skew resolution is 340ps
1	ASKEW [1]	0	Expand the skew direction is same as CPU_3V66_SKEW [2:0] setting
0	ASKEW [0]	0	

## W83194BR-603/W83194BG-603



### 7.17 Register 16: Control Register (Default: 24h)

BIT	NAME	PWD	DESCRIPTION
7	INV_3V66	0	Invert the 3V66 phase, 0: Default, 1: Inverse
6	INV_PCI	0	Invert the PCI phase, 0: Default, 1: Inverse
5	SSKEW [2]	1	CPU to SRC skew control, Skew resolution is 340ps Expand the skew direction is same as CPU_SRC_SKEW [2:0] setting
4	SSKEW [1]	0	
3	SSKEW [0]	0	
2	PSKEW [2]	1	CPU to PCI skew control, Skew resolution is 340ps Expand the skew direction is same as CPU_PCI_SKEW [2:0] setting
1	PSKEW [1]	0	
0	PSKEW [0]	0	

### 7.18 Register 17: Slew rate Control Register (Default: 00h)

BIT	NAME	PWD	DESCRIPTION
7	PCI_F2_S2	0	PCI_F2 slew rate control 11: Strong, 00: Weak, 10/01: Normal
6	PCI_F2_S1	0	
5	PCI_F0_S2	0	PCI_F1 / PCI_F0 slew rate control 11: Strong, 00: Weak, 10/01: Normal
4	PCI_F0_S1	0	
3	3V66_2_S2	0	3V66_2 slew rate control 11: Strong, 00: Weak, 10/01: Normal
2	3V66_2_S1	0	
1	3V66_10_S2	0	3V66_1 /3V66_0 slew rate control 11: Strong, 00: Weak, 10/01: Normal
0	3V66_10_S1	0	

### 7.19 Register 18: Slew rate Control Register (Default: 00h)

BIT	NAME	PWD	DESCRIPTION
7	PCI_65_S2	0	PCI6, 5 slew rate control 11: Strong, 00: Weak, 10/01: Normal
6	PCI_65_S1	0	
5	PCI_42_S2	0	PCI4, 3,2 slew rate control 11: Strong, 00: Weak, 10/01: Normal
4	PCI_42_S1	0	
3	PCI_10_S2	0	PCI1, 0 slew rate control 11: Strong, 00: Weak, 10/01: Normal
2	PCI_10_S1	0	
1	REF_S2	0	REF0, 1 slew rate control 11: Strong, 00: Weak, 10/01: Normal
0	REF_S1	0	

## W83194BR-603/W83194BG-603



### 7.20 Register 19: Control Register (Default: D2h)

BIT	NAME	PWD	DESCRIPTION
7	CPU1STOP_EN	1	Stop CPU1 clocks, 1: Enable stop feature, 0: Disable
6	CPU0STOP_EN	1	Stop CPU0 clocks, 1: Enable stop feature, 0: Disable
5	SRC_S2	0	SRC slew rate control 11: Strong, 00: Weak, 10/01: Normal
4	SRC_S1	1	
3	INV_48MHz	0	Invert the 48MHz phase, 0: In phase with 24_48MHz 1: 180 degrees out of phase
2	48MHz_S2	0	48MHz/24_48MHz slew rate control 11: Strong, 00: Weak, 10/01: Normal
1	48MHz_S1	1	
0	MODE	X	Pin 30 Mode selection, 1: RESET# output, 0: 3V66_0 (Default) Default value follow hardware trapping data on MODE <sup>8</sup> /PCI0 pin.

### 7.21 Register 20: Watch dog timer Register (Default: 88h)

BIT	NAME	PWD	DESCRIPTION
7	SRCF1	1	SRC frequency select, 00/01: 25MHz, 10: 100MHZ(Default), 11: 200MHz
6	WD_TIME [6]	0	Setting the down count depth. One bit resolution represents 250ms. Default time depth is 8*250ms = 2.0 second. If the watchdog timer is counting, this register will return present down count value
5	WD_TIME [5]	0	
4	WD_TIME [4]	0	
3	WD_TIME [3]	1	
2	WD_TIME [2]	0	
1	WD_TIME [1]	0	
0	WD_TIME [0]	0	

### 7.22 Register21: Control Register (Default: 00h)

BIT	NAME	PWD	DESCRIPTION	
7	Tri-state	0	Tri-state all output if set 1	
6	Reserved	0	Don't modify it	
5	Reserved	0	Don't modify it	
4	FIX_SEL	0	3V66 output frequency select mode 0: Output frequency according to frequency selection table 1: Output frequency according to FIX frequency Reg21 bit 0~2	
3	SRCF0	0	SRC frequency select, 0:100MHz. (Default), 1:200MHz	
2	ASEL_2	0	Asynchronous 3V66/PCI frequency table selection ASEL_ <2:0>	
1	ASEL_1	0		
0	ASEL_0	0		001: 66 / 33M      010: 75.43 / 37.7M
				011: 88 / 44M      100: 88 / 44M
			101: 66 / 33M      110: 75.43 / 33M	
			111: 88 / 33M      000: Clock from PLL1	

# W83194BR-603/W83194BG-603



## 8. ACCESS INTERFACE

The W83194BR-603 provides I<sup>2</sup>C Serial Bus for microprocessor to read/write internal registers. In the W83194BR-603 is provided Block Read/Block Write and Byte-Data Read/Write protocol. The I<sup>2</sup>C address is defined at 0xD2.

Block Read and Block Write Protocol

### 8.1 Block Write protocol

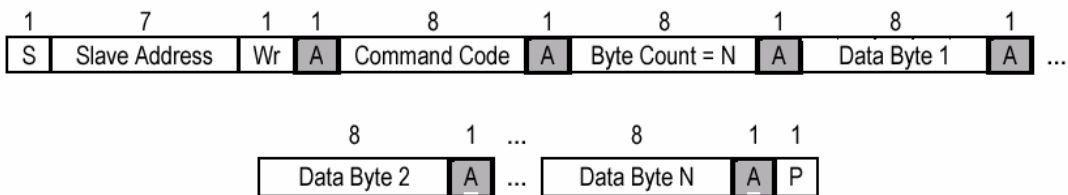

### 8.2 Block Read protocol

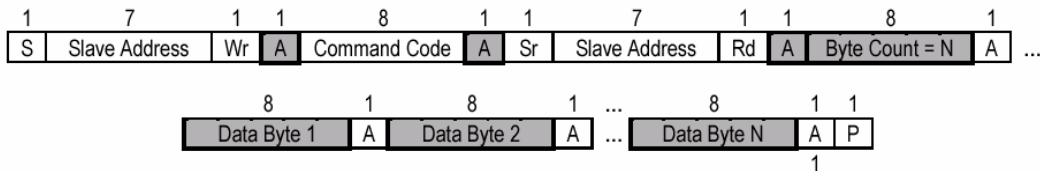

## In block mode, the command code must filled 8'h00

### 8.3 Byte Write protocol

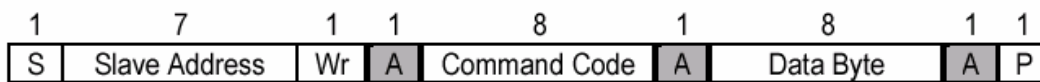

### 8.4 Byte Read protocol

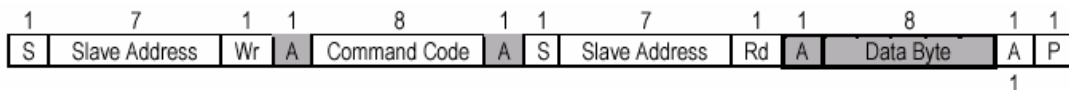

# W83194BR-603/W83194BG-603



## 9. SPECIFICATIONS

### 9.1 ABSOLUTE MAXIMUM RATINGS

Stresses greater than those listed in this table may cause permanent damage to the device. Precautions should be taken to avoid application of any voltage higher than the maximum rated voltages to this circuit. Subjection to maximum conditions for extended periods may affect reliability. Unused inputs must always be tied to an appropriate logic voltage level (Ground or VDD).

PARAMETER	RATING
Absolute 3.3V Core Supply Voltage	-0.5V to +4.6V
Absolute 3.3V I/O Supply Voltage	- 0.5 V to + 4.6 V
Operating 3.3V Core Supply Voltage	3.135V to 3.465V
Operating 3.3V I/O Supply Voltage	3.135V to 3.465V
Storage Temperature	- 65°C to + 150°C
Ambient Temperature	- 55°C to + 125°C
Operating Temperature	0°C to + 70°C
Input ESD protection (Human body model)	2000V

### 9.2 General Operating Characteristics

VDDA=VDD3V66=VDDCPU=VDDREF=VDDPCI= 3.3V ± 5 %, TA = 0°C to +70°C, CI=10pF					
PARAMETER	SYMBOL	MIN	MAX	UNITS	TEST CONDITIONS
Input Low Voltage	V <sub>IL</sub>		0.8	V <sub>dc</sub>	
Input High Voltage	V <sub>IH</sub>	2.0		V <sub>dc</sub>	
Output Low Voltage	V <sub>OL</sub>		0.4	V <sub>dc</sub>	All outputs using 3.3V power
Output High Voltage	V <sub>OH</sub>	2.4		V <sub>dc</sub>	All outputs using 3.3V power
Operating Supply Current	I <sub>dd</sub>		350	mA	CPU = 100 to 400 MHz PCI = 33.3 MHz with load
Input pin capacitance	C <sub>in</sub>		5	pF	
Output pin capacitance	C <sub>out</sub>		6	pF	
Input pin inductance	L <sub>in</sub>		7	nH	

### 9.3 Skew Group timing clock

VDDA=VDD3V66=VDDCPU=VDDREF=VDDPCI = 3.3V ± 5 %, TA = 0°C to +70°C, CI=10pF					
PARAMETER	MIN	TYP	MAX	UNITS	TEST CONDITIONS
3V66 to PCI Skew	1.5	2.6	3.5	ns	Measured at 1.5V
CPU to CPU Skew			200	ps	Crossing point
3V66 to 3V66 Skew			250	ps	Measured at 1.5V
PCI to PCI Skew			500	ps	Measured at 1.5V
48MHz to 48MHz Skew			1000	ps	Measured at 1.5V
REF to REF Skew			500	ps	Measured at 1.5V

## W83194BR-603/W83194BG-603



### 9.4 CPU 0.7V Electrical Characteristics

<i>VDDA=VDDCPU= 3.3V ± 5 %, TA = 0°C to +70°C, Test load Rs=33, Rp=49.9 CI=10pF, Vr=475, IREF=2.32mA, loh=6*IREF</i>				
PARAMETER	MIN	MAX	UNITS	TEST CONDITIONS
Rise Time	175	700	ps	100 to 200 Mhz
Fall Time	175	700	ps	100 to 200Mhz
Absolute crossing point Voltages	250	550	mV	100 to 200Mhz
Cycle to Cycle jitter		150	ps	100 to 200Mhz
Duty Cycle	45	55	%	100 to 200Mhz

### 9.5 3V66 Electrical Characteristics

<i>VDD3V66= 3.3V ± 5 %, TA = 0°C to +70°C, Test load, CI=10pF,</i>				
PARAMETER	MIN	MAX	UNITS	TEST CONDITIONS
Rise Time	500	2000	ps	
Fall Time	500	2000	ps	
Cycle to Cycle jitter		250	ps	
Duty Cycle	45	55	%	
Pull-Up Current Min	-33		mA	Vout=1.0V
Pull-Up Current Max		-33	mA	Vout=3.135V
Pull-Down Current Min	30		mA	Vout=1.95V
Pull-Down Current Max		38	mA	Vout=0.4V

### 9.6 PCI Electrical Characteristics

<i>VDDPCI= 3.3V ± 5 %, TA = 0°C to +70°C, Test load, CI=10pF,</i>				
PARAMETER	MIN	MAX	UNITS	TEST CONDITIONS
Rise Time	500	2000	ps	
Fall Time	500	2000	ps	
Cycle to Cycle jitter		250	ps	
Duty Cycle	45	55	%	
Pull-Up Current Min	-33		mA	Vout=1.0V
Pull-Up Current Max		-33	mA	Vout=3.135V
Pull-Down Current Min	30		mA	Vout=1.95V
Pull-Down Current Max		38	mA	Vout=0.4V

## W83194BR-603/W83194BG-603



CLOCK GEN. FOR INTEL P4 SPRINGDALE/PRESCOTT SERIES CHIPSET

### 9.7 24M, 48M Electrical Characteristics

<b>VDD48= 3.3V ± 5 %, TA = 0°C to +70°C, Test load, CI=10pF,</b>				
<b>PARAMETER</b>	<b>MIN</b>	<b>MAX</b>	<b>UNITS</b>	<b>TEST CONDITIONS</b>
Rise Time	500	2000	ps	
Fall Time	500	2000	ps	
Long term jitter		500	ps	
Duty Cycle	45	55	%	
Pull-Up Current Min	-33		mA	Vout=1.0V
Pull-Up Current Max		-33	mA	Vout=3.135V
Pull-Down Current Min	30		mA	Vout=1.95V
Pull-Down Current Max		38	mA	Vout=0.4V

### 9.8 REF Electrical Characteristics

<b>VDDREF= 3.3V ± 5 %, TA = 0°C to +70°C, Test load, CI=10pF,</b>				
<b>PARAMETER</b>	<b>MIN</b>	<b>MAX</b>	<b>UNITS</b>	<b>TEST CONDITIONS</b>
Rise Time	1000	4000	ps	
Fall Time	1000	4000	ps	
Cycle to Cycle jitter		1000	ps	
Duty Cycle	45	55	%	
Pull-Up Current Min	-33		mA	Vout=1.0V
Pull-Up Current Max		-33	mA	Vout=3.135V
Pull-Down Current Min	30		mA	Vout=1.95V
Pull-Down Current Max		38	mA	Vout=0.4V

## 10. ORDERING INFORMATION

<b>PART NUMBER</b>	<b>PACKAGE TYPE</b>	<b>PRODUCTION FLOW</b>
W83194BR-603	48 PIN SSOP	Commercial, 0°C to +70°C
W83194BG-603	48 PIN SSOP (Pb-free package)	Commercial, 0°C to +70°C

## W83194BR-603/W83194BG-603



### 11. HOW TO READ THE TOP MARKING

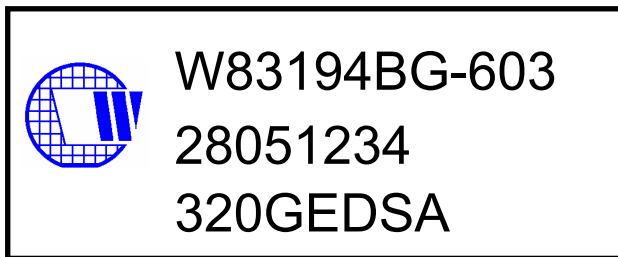
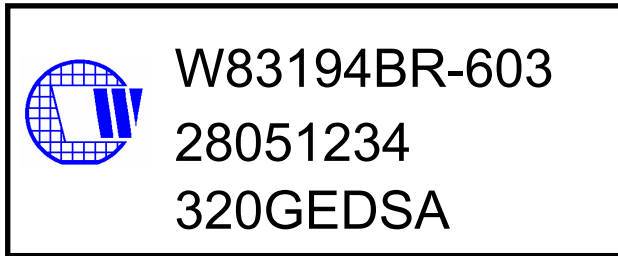

1st line: Winbond logo and the type number: W83194BR-603/W83194BG-603

2nd line: Tracking code 2 8051234

2: wafers manufactured in Winbond FAB 2

8051234: wafer production series lot number

3rd line: Tracking code 320 G E D SA

320: packages made in '2003, week 20

G: assembly house ID; O means OSE, G means GR

E: Internal use code

D: IC revision

SA: mask version

All the trademarks of products and companies mentioned in this data sheet belong to their respective owners.



# W83194BR-603/W83194BG-603



## 12. PACKAGE DRAWING AND DIMENSIONS

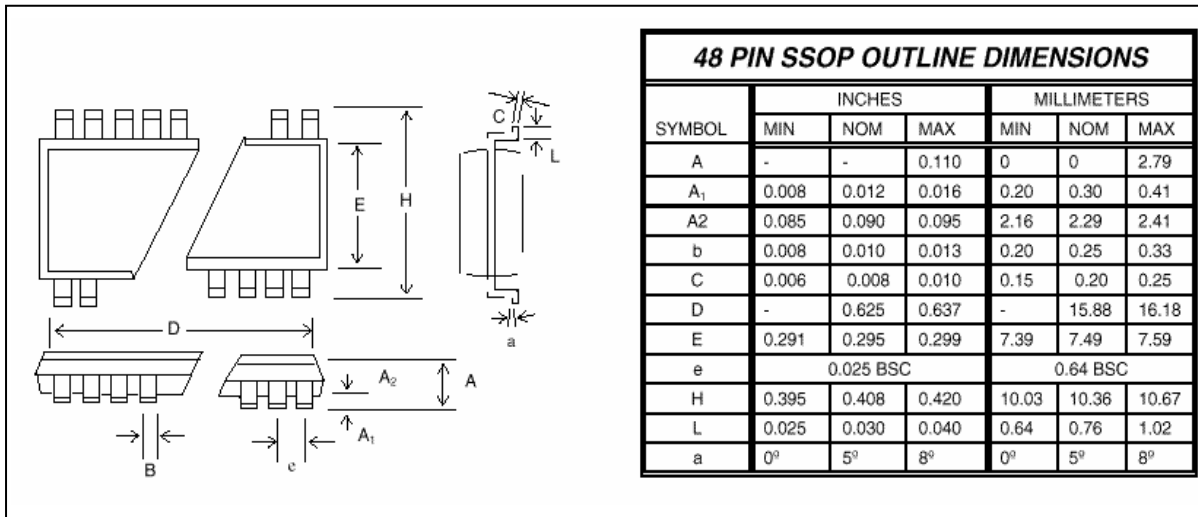

Please note that all data and specifications are subject to change without notice. All the trade marks of products and companies mentioned in this data sheet belong to their respective owners.

**W83194BR-603/W83194BG-603**



### **Important Notice**

Winbond products are not designed, intended, authorized or warranted for use as components in systems or equipment intended for surgical implantation, atomic energy control instruments, airplane or spaceship instruments, transportation instruments, traffic signal instruments, combustion control instruments, or for other applications intended to support or sustain life. Further more, Winbond products are not intended for applications wherein failure of Winbond products could result or lead to a situation wherein personal injury, death or severe property or environmental damage could occur.

Winbond customers using or selling these products for use in such applications do so at their own risk and agree to fully indemnify Winbond for any damages resulting from such improper use or sales.