

13.5-17.0/27.0-34.0 GHz Doubler QFN, 3X3mm



February 2008 - Rev 06-Feb-08

XX1007-QT
RoHS

Features

- ✕ Integrated Gain, Doubler and Driver Stages
- ✕ Single Positive Supply, +5V
- ✕ Integrated Bypassing Capacitor
- ✕ +20.0 dBm Output Saturated Power
- ✕ 35.0 dBc Fundamental Suppression
- ✕ On-Chip ESD Protection
- ✕ 100% RF, DC and Output Power Testing
- ✕ 3x3 QFN Package
- ✕ RoHS Compliant

Chip Device Layout



General Description

Mimix Broadband's 13.5-17.0 / 27.0-34.0 GHz GaAs MMIC doubler integrates a gain stage, passive doubler and driver amplifier onto a single device. The XX1007-QT has a self-biased architecture requiring a single positive supply (+5V) only and integrated on-chip bypassing and DC blocking capacitors eliminating the need for any external components. This device uses Mimix Broadband's 0.15um GaAs PHEMT device model technology, and is based upon electron beam lithography to ensure high repeatability and uniformity. XX1007-QT has integrated ESD structures for protection and comes in a low cost 3x3mm QFN package. The device is well suited for Millimeter wave Point-to-Point Radio, LMDS, SATCOM and VSAT applications.

Absolute Maximum Ratings

Supply Voltage (Vd)	+6.0 VDC
Supply Current (Id)	300 mA
Gate Bias Voltage (Vg)	+0.3 VDC
Input Power (RF Pin)	10 dBm
Storage Temperature (Tstg)	-65 to +165 °C
Operating Temperature (Ta)	-55 to MTTF Table ¹
Channel Temperature (Tch)	MTTF Table ¹

(1) Channel temperature affects a device's MTTF. It is recommended to keep channel temperature as low as possible for maximum life.

Electrical Characteristics (Ambient Temperature T = 25 °C)

Parameter	Units	Min.	Typ.	Max.
Input Frequency Range (fin)	GHz	13.5	-	17.0
Output Frequency Range (fout)	GHz	27.0	-	34.0
Input Return Loss (S11)	dB	-	-8.0	-
Output Return Loss (S22)	dB	-	-10.0	-
Fundamental Suppression	dBc	-	-35.0	-
RF Input Power (RF Pin)	dBm	-	7.0	-
Output Power at 5.0 dBm Pin (Pout)	dBm	-	+20.0	-
Drain Bias Voltage (Vd)	VDC	-	+5.0	+5.5
Supply Current (Id1,2,3) (Vd=5.0V Typical)	mA	-	200	240



13.5-17.0/27.0-34.0 GHz Doubler QFN, 3X3mm



February 2008 - Rev 06-Feb-08

X1007-QT
RoHS

Doubler Measurements

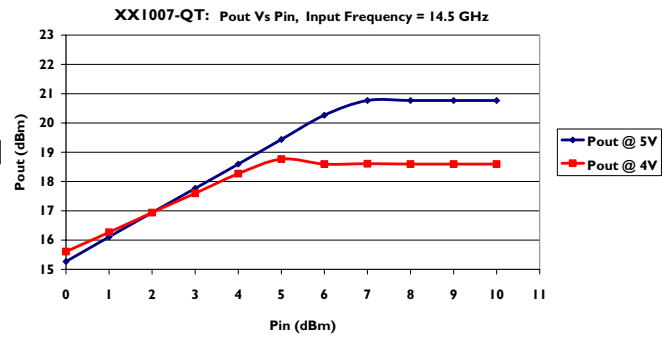
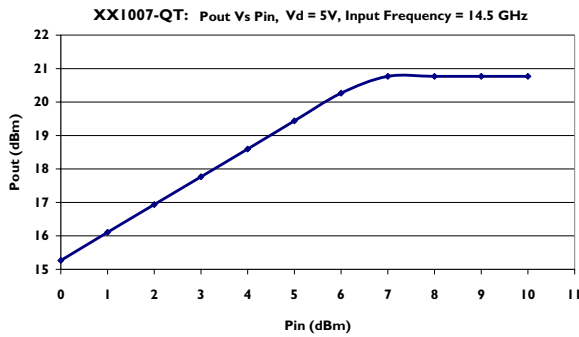
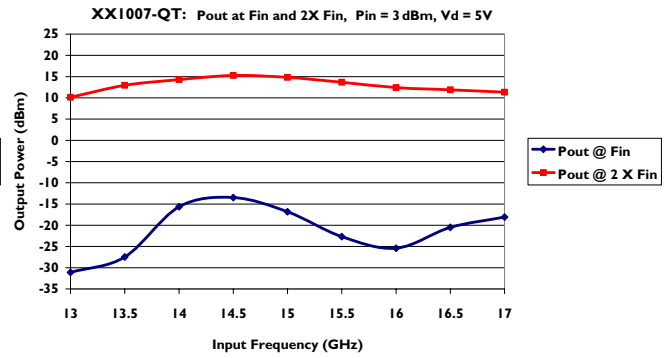
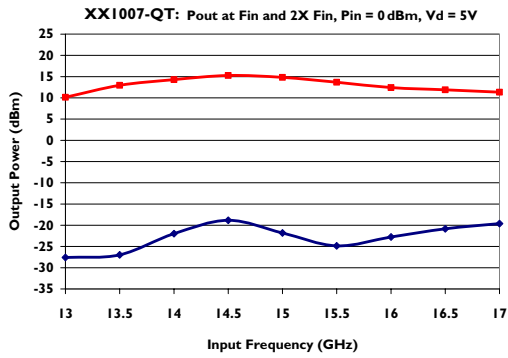
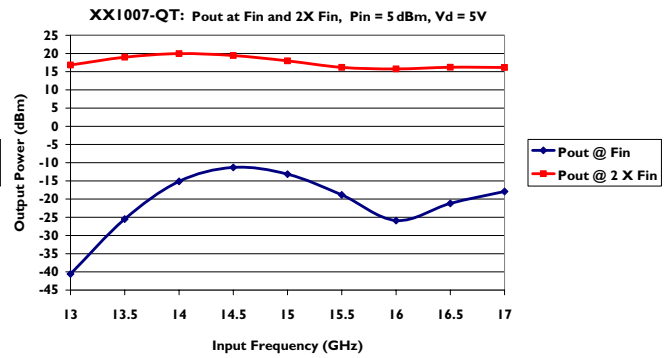
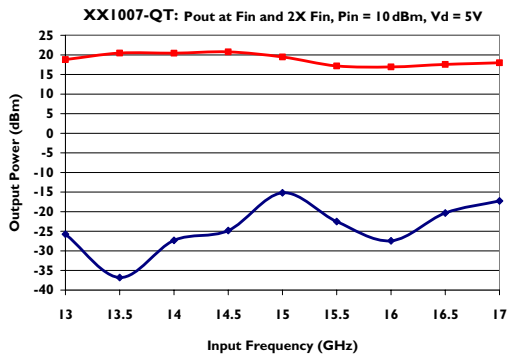

13.5-17.0/27.0-34.0 GHz Doubler QFN, 3X3mm



February 2008 - Rev 06-Feb-08

X1007-QT
RoHS

Doubler Measurements (cont.)

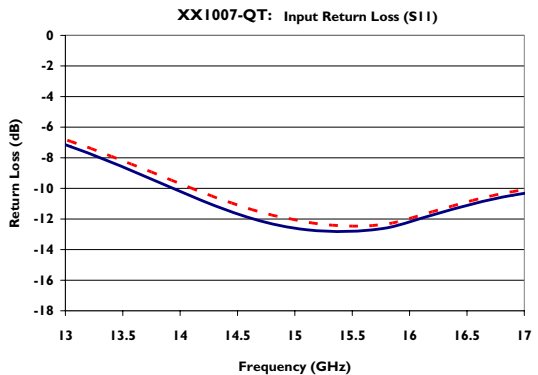
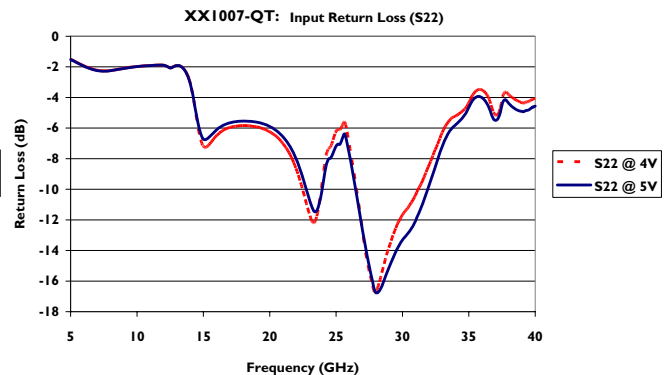
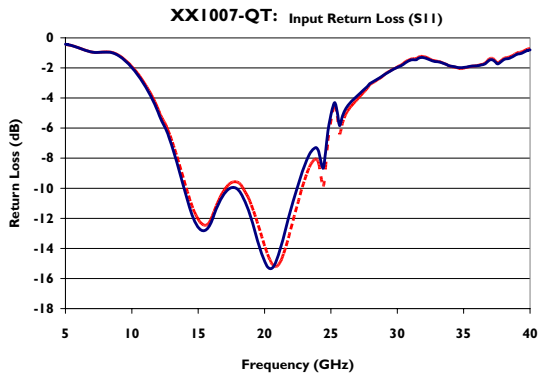
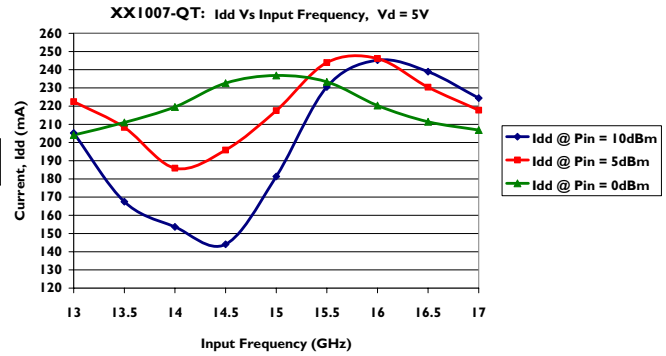
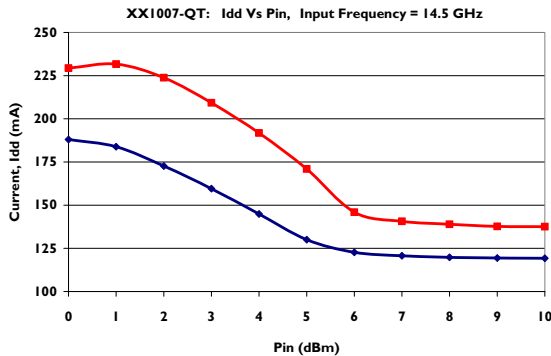

13.5-17.0/27.0-34.0 GHz Doubler QFN, 3X3mm



February 2008 - Rev 06-Feb-08

XX1007-QT
RoHS

Functional Block Diagram

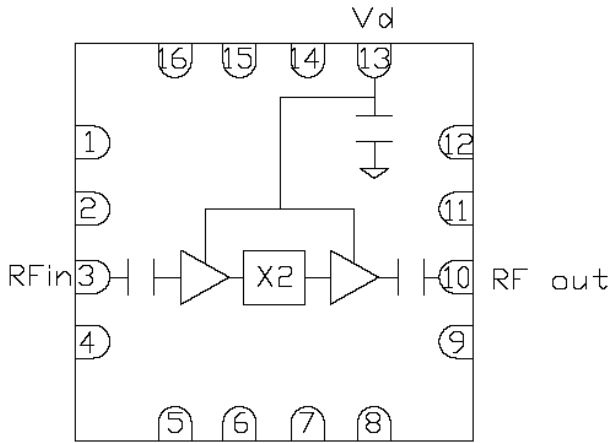

Pin Designation

Pin Number	Function	Typ. Value	Unit
3	RF in	5	dBm
10	RF out	20	dBm
13	Vd	5	V
1,2,4,5,6,7,8,9	NC		
11,12,14,15,16	NC		

NC: No Connection

Physical Dimensions

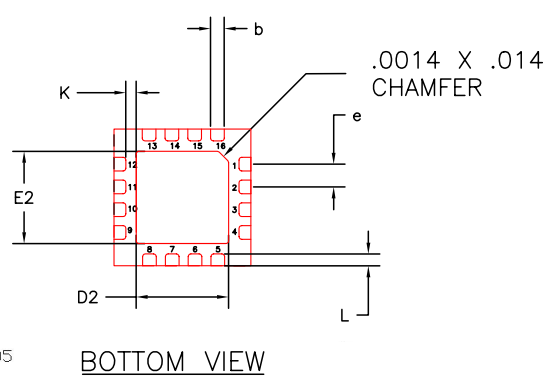
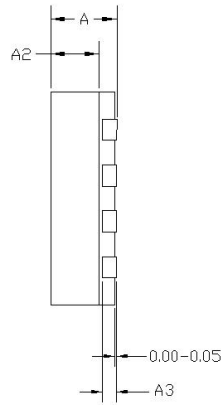
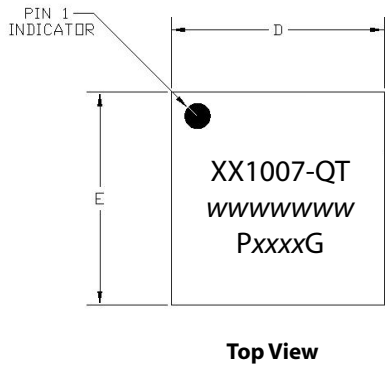

RECOMMENDED SOLDER PAD PITCH AND DIMENSIONS

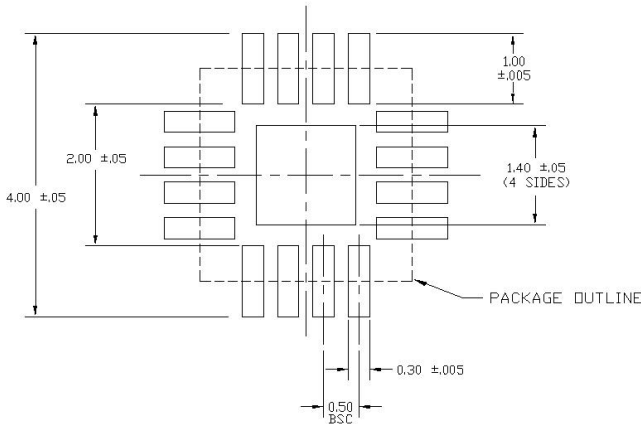

NOTE:
1. ALL DIMENSIONS ARE IN mm

	MIN	NOM	MAX
A	0.80	0.90	1.00
A3	0.20 REF		
A2	0	0.65	1.00
b	0.20	0.25	0.30
K	0.20	-	-
D	3.00 BSC		
E	3.00 BSC		
e	0.50		
D2	1.50	1.65	1.80
E2	1.50	1.65	1.80
L	0.16	0.26	0.36

13.5-17.0/27.0-34.0 GHz Doubler QFN, 3X3mm

February 2008 - Rev 06-Feb-08

X1007-QT
RoHS

Evaluation Board Layout

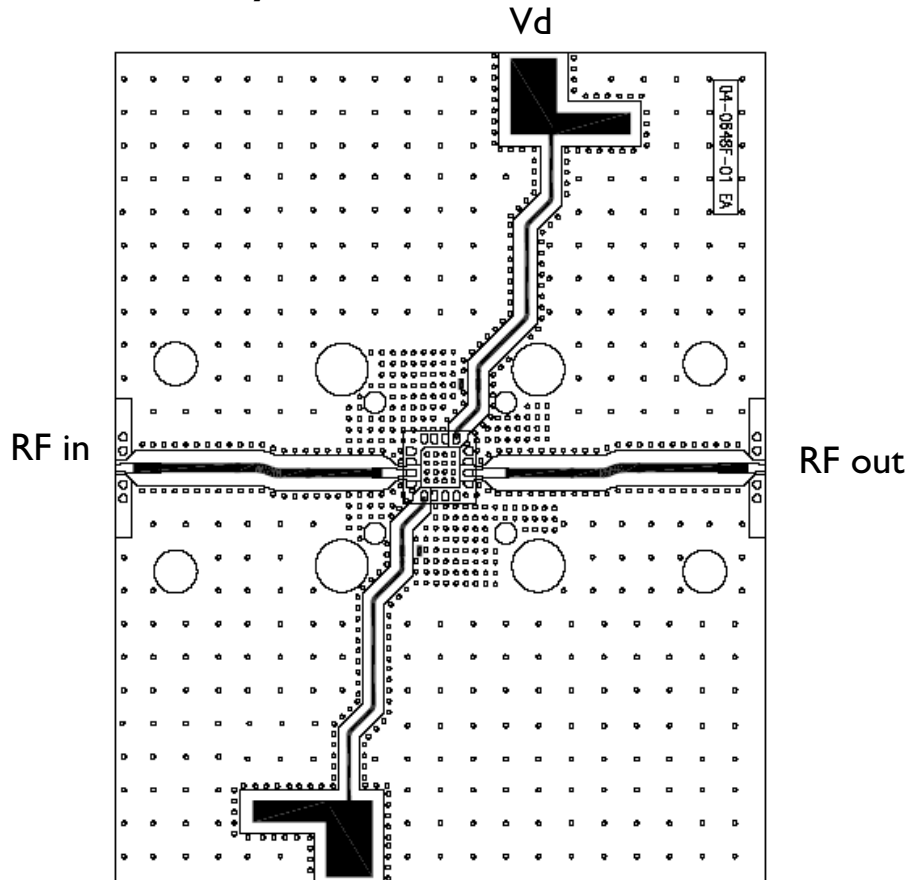

MTTF Tables (TBD)

These numbers were calculated based on accelerated life test information and thermal model analysis received from the fabricating foundry.

Backplate Temperature	Channel Temperature	Rth	MTTF Hours	FITs
75 deg Celsius	192 deg Celsius	126 C/W	3.4 E+06	2.9 E+02

Bias Conditions: Vd=5.0V, Id=200mA

13.5-17.0/27.0-34.0 GHz Doubler QFN, 3X3mm



February 2008 - Rev 06-Feb-08

X1007-QT
RoHS

Handling and Assembly Information

CAUTION! - Mimix Broadband MMIC Products contain gallium arsenide (GaAs) which can be hazardous to the human body and the environment. For safety, observe the following procedures:

- Do not ingest.
- Do not alter the form of this product into a gas, powder, or liquid through burning, crushing, or chemical processing as these by-products are dangerous to the human body if inhaled, ingested, or swallowed.
- Observe government laws and company regulations when discarding this product. This product must be discarded in accordance with methods specified by applicable hazardous waste procedures.

Life Support Policy - Mimix Broadband's products are not authorized for use as critical components in life support devices or systems without the express written approval of the President and General Counsel of Mimix Broadband. As used herein: (1) Life support devices or systems are devices or systems which, (a) are intended for surgical implant into the body, or (b) support or sustain life, and whose failure to perform when properly used in accordance with instructions for use provided in the labeling, can be reasonably expected to result in a significant injury to the user. (2) A critical component is any component of a life support device or system whose failure to perform can be reasonably expected to cause the failure of the life support device or system, or to affect its safety or effectiveness.

Package Attachment - This packaged product from Mimix Broadband is provided as a rugged surface mount package compatible with high volume solder installation. The package is a low-cost plastic package. Vacuum tools or other suitable pick and place equipment may be used to pick and place this part. Care should be taken to ensure that there are no voids or gaps in the solder connection so that good RF, DC and ground connections are maintained. Voids or gaps can eventually lead not only to RF performance degradation, but reduced reliability and life of the product due to thermal stress.

Typical Reflow Profiles

Reflow Profile	SnPb	Pb Free
Ramp Up Rate	3-4 °C/sec	3-4 °C/sec
Activation Time and Temperature	60-120 sec @ 140-160 °C	60-180 sec @ 170-200 °C
Time Above Melting Point	60-150 sec	60-150 sec
Max Peak Temperature	240 °C	265 °C
Time Within 5 °C of Peak	10-20 sec	10-20 sec
Ramp Down Rate	4-6 °C/sec	4-6 °C/sec

Mimix Lead-Free RoHS Compliant Program - Mimix has an active program in place to meet customer and governmental requirements for eliminating lead (Pb) and other environmentally hazardous materials from our products. All Mimix RoHS compliant components are form, fit and functional replacements for their non-RoHS equivalents. Lead plating of our RoHS compliant parts is 100% matte tin (Sn) over copper alloy and is backwards compatible with current standard SnPb low-temperature reflow processes as well as higher temperature (260°C reflow) "Pb Free" processes.

Ordering Information

Part Number for Ordering

XX1007-QT-0G00

XX1007-QT-0G0T

XX1007-QT-EV1

Description

Matte Tin plated RoHS compliant QFN 3x3 16L surface mount package in bulk quantity

Matte Tin plated RoHS compliant QFN 3x3 16L surface mount package in tape and reel

XX1007-QT Evaluation Board

We also offer this part with alternative plating. Please contact your regional sales manager for more information regarding different plating types.



Caution: ESD Sensitive
Appropriate precautions in handling, packaging
and testing devices must be observed.

Proper ESD procedures should be followed when handling this device.

Mimix Broadband, Inc., 10795 Rockley Rd., Houston, Texas 77099
Tel: 281.988.4600 Fax: 281.988.4615 mimixbroadband.com

Page 6 of 6