

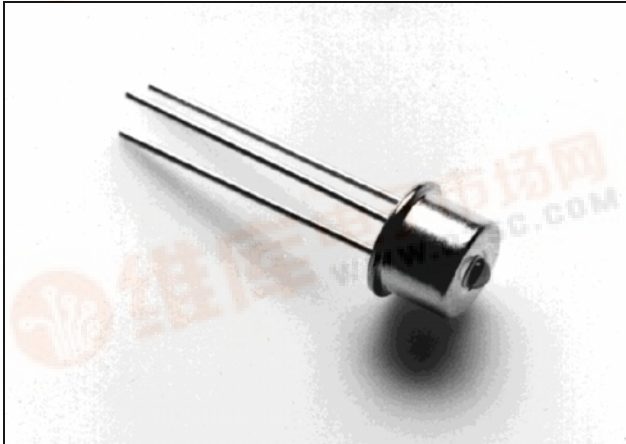

ZL60005 VCSEL Laser Diode

Data Sheet

August 2004



Ordering Information

ZL60005/TBD	TO-46 Package
ZL60005/TDD	ST Housing
ZL60005/TGD	SMA Housing

0°C to +70°C

Note: Rated Optical Power apply only on the TO-46 package, for housing options optical power is typically 10% less.

Warning: Laser Radiation, avoid exposure to beam. Class 3B laser product, potential eye hazard. Warning labels in each box.

Features

- High power
- Low beam divergence
- Low drive current
- Hermetically sealed
- Easy alignment

Applications

- Fiber optic datalinks
- Position sensor
- Range finder
- Free air datalinks
- Optical storage

Description

This High-Power VCSEL (Vertical Cavity Surface-Emitting Laser) is designed for industrial and sensors applications. It operates in multiple transverse and single longitudinal mode, ensuring stable output power and low noise.

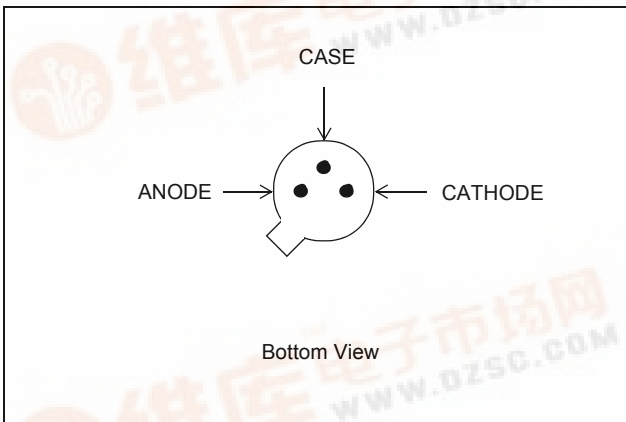

Figure 1 - Pin Description

Optical and Electrical Characteristics - Case Temperature 25°C

Parameter	Symbol	Min.	Typ.	Max.	Unit	Test Condition
Optical Power	P_o	6	7		mW	$I_F=40$ mA. Note 1
Slope Efficiency (dP _o /dI _F)	h		300		mW/A	$I_F=40$ mA
Beam Divergence	Θ		11		deg	Full Width at I/e^2
Bandwidth 3 dB _{el})	f_c	1			GHz	$I_F=40$ mA
Peak Wavelength	λ_p	830	845	860	nm	$I_F=40$ mA
Spectral Width	DI		0.5	1.5	nm	$I_F=40$ mA
Forward voltage	V_F		2.0	2.3	V	$I_F=40$ mA
Threshold Current	I_{th}		14	19	mA	

Note 1: Measured with 10 ms pulse.

Absolute Maximum Ratings - Not necessarily applied together. Exceeding these values may cause permanent damage. Functional operation under these conditions is not implied.

Parameter	Symbol	Limit
Storage Temperature	T_{stg}	-55 to +125°C
Operating Temperature	T_{op}	0 to +70°C
Electrical Power Dissipation	P_{tot}	100 mW
Continuous Forward Current (f<10 kHz)	I_F	50 mA
Peak Forward Current (duty Cycle<50%, f>1 MHz)	I_{FRM}	80 mA
Reverse Voltage	V_R	1.5 V
Soldering Temperature (2 mm from the case for 10 sec.)	T_{sld}	260°C

Thermal characteristics

Parameter	Symbol	Min.	Typ.	Max.	Unit
Thermal Resistance - Infinite Heat Sink	R_{thjc}		200		°C/W
Thermal Resistance - No Heat Sink	R_{thja}		500		°C/W
Temp Coefficient - Wavelength	$d\lambda/dT_j$		0.06		nm/°C
Optical Power - Variation 0 to 70°C	ΔP		3		dB
Threshold Current - Variation 0 to 70°C	ΔI_{th}		5		mA

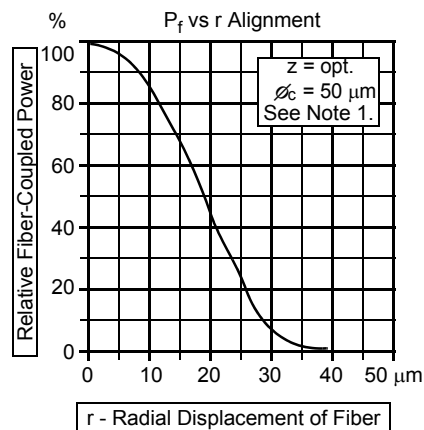
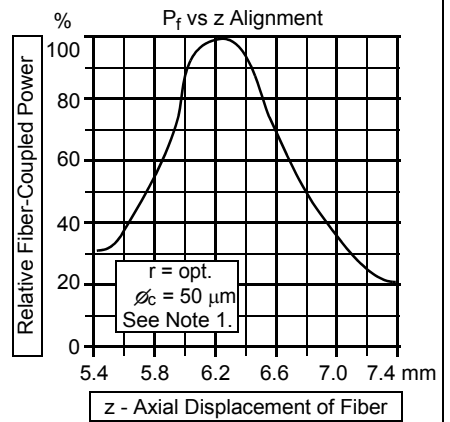
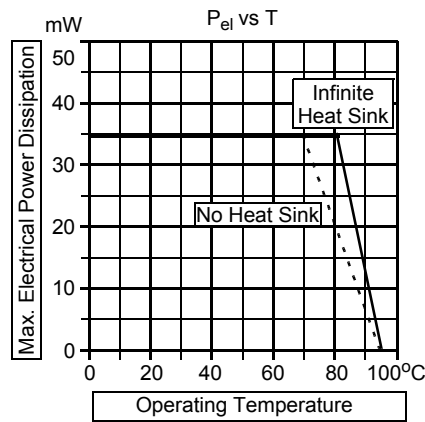
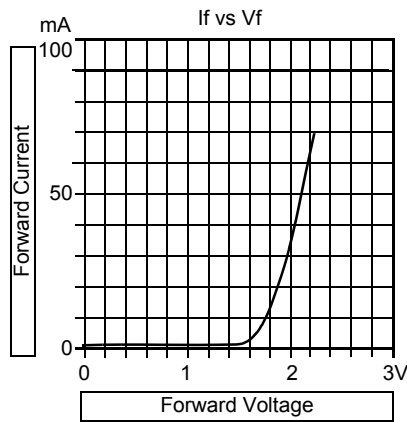
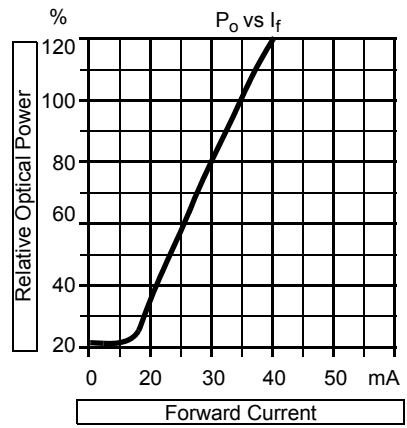
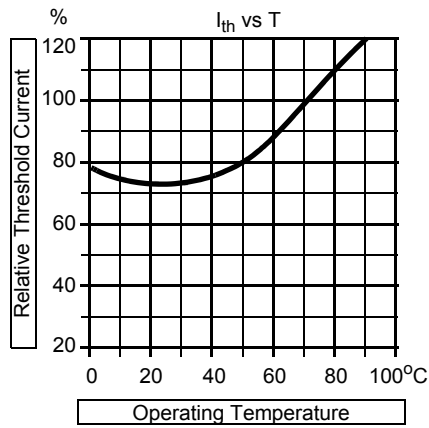
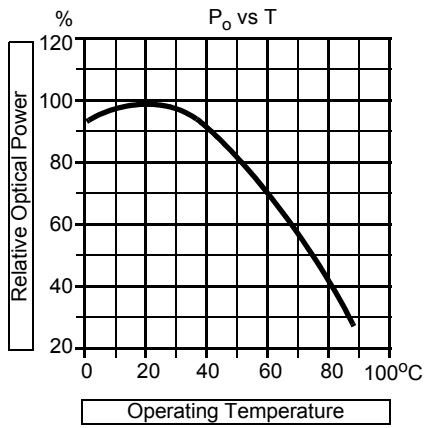

Note 1

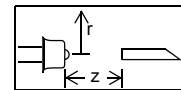

BOTTOM VIEW (10 : 1)

SIDE VIEW

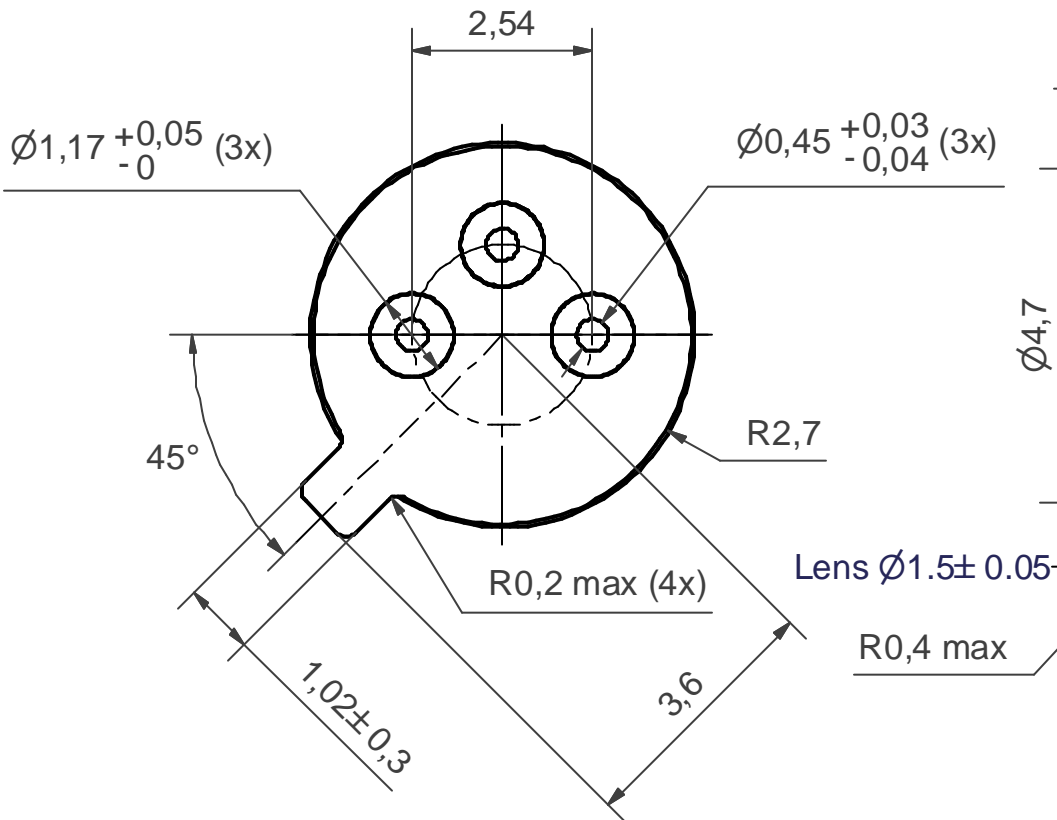

NOTES:-

1. All dimensions in mm.
2. General tol. ISO-2768-mK.
3. Coating: Case: Ni 1,5-2,5
Header: Ni 2-3 µm

© Zarlink Semiconductor 2002. All rights reserved.

ISSUE	1			
ACN	JS004076R1A			
DATE	22-MAR-03			
APPRD.	TD/BE			



Previous package codes

Pack

Drawn
Pack

Title



**For more information about all Zarlink products
visit our Web Site at
www.zarlink.com**

Information relating to products and services furnished herein by Zarlink Semiconductor Inc. or its subsidiaries (collectively "Zarlink") is believed to be reliable. However, Zarlink assumes no liability for errors that may appear in this publication, or for liability otherwise arising from the application or use of any such information, product or service or for any infringement of patents or other intellectual property rights owned by third parties which may result from such application or use. Neither the supply of such information or purchase of product or service conveys any license, either express or implied, under patents or other intellectual property rights owned by Zarlink or licensed from third parties by Zarlink, whatsoever. Purchasers of products are also hereby notified that the use of product in certain ways or in combination with Zarlink, or non-Zarlink furnished goods or services may infringe patents or other intellectual property rights owned by Zarlink.

This publication is issued to provide information only and (unless agreed by Zarlink in writing) may not be used, applied or reproduced for any purpose nor form part of any order or contract nor to be regarded as a representation relating to the products or services concerned. The products, their specifications, services and other information appearing in this publication are subject to change by Zarlink without notice. No warranty or guarantee express or implied is made regarding the capability, performance or suitability of any product or service. Information concerning possible methods of use is provided as a guide only and does not constitute any guarantee that such methods of use will be satisfactory in a specific piece of equipment. It is the user's responsibility to fully determine the performance and suitability of any equipment using such information and to ensure that any publication or data used is up to date and has not been superseded. Manufacturing does not necessarily include testing of all functions or parameters. These products are not suitable for use in any medical products whose failure to perform may result in significant injury or death to the user. All products and materials are sold and services provided subject to Zarlink's conditions of sale which are available on request.

Purchase of Zarlink's I²C components conveys a licence under the Philips I²C Patent rights to use these components in and I²C System, provided that the system conforms to the I²C Standard Specification as defined by Philips.

Zarlink, ZL and the Zarlink Semiconductor logo are trademarks of Zarlink Semiconductor Inc.

Copyright Zarlink Semiconductor Inc. All Rights Reserved.

TECHNICAL DOCUMENTATION - NOT FOR RESALE
