



Part Number: **ZMDKVG45W**

3.5x2.8mm PLCC4 SMD LED

**Features**

- BOTH CHIPS CAN BE CONTROLLED SEPARATELY.
- SUITABLE FOR ALL SMT ASSEMBLY AND SOLDER PROCESS.
- AVAILABLE ON TAPE AND REEL.
- PACKAGE: 1500PCS / REEL.
- MOISTURE SENSITIVITY LEVEL : LEVEL 4.
- RoHS COMPLIANT.

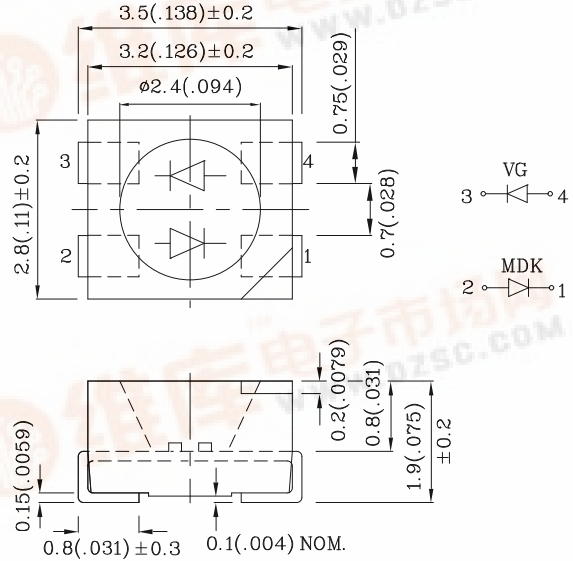

Notes:

1. All dimensions are in millimeters (inches).
2. Tolerance is ± 0.25(0.01") unless otherwise noted.
3. Specifications are subject to change without notice.

Absolute Maximum Ratings (TA=25°C)		MDK (InGaAlP)	VG (InGaAlP)	Unit
Reverse Voltage	V <sub>R</sub>	5	5	V
Forward Current	I <sub>F</sub>	30	30	mA
Forward Current (Peak) 1/10Duty Cycle 0.1ms Pulse Width	i <sub>FS</sub>	185	150	mA
Power Dissipation	P <sub>T</sub>	75	75	mW
Operating Temperature	T <sub>A</sub>	-40 ~ +85		°C
Storage Temperature	T <sub>stg</sub>	-40 ~ +85		

Operating Characteristics (TA=25°C)		MDK (InGaAlP)	VG (InGaAlP)	Unit
Forward Voltage (Typ.) (I <sub>F</sub> =20mA)	V <sub>F</sub>	1.95	2.1	V
Forward Voltage (Max.) (I <sub>F</sub> =20mA)	V <sub>F</sub>	2.5	2.5	V
Reverse Current (Max.) (V <sub>R</sub> =5V)	I <sub>R</sub>	10	10	µA
Wavelength Of Peak Emission (Typ.) (I <sub>F</sub> =20mA)	λ <sub>P</sub>	650	574	nm
Wavelength Of Dominant Emission (Typ.) (I <sub>F</sub> =20mA)	λ <sub>D</sub>	635	570	nm
Spectral Line Full Width At Half-Maximum (Typ.) (I <sub>F</sub> =20mA)	Δλ	28	20	nm
Capacitance (Typ.) (V <sub>F</sub> =0V, f=1MHz)	C	35	15	pF

Part Number	Emitting Color	Emitting Material	Lens-color	Luminous Intensity (I <sub>F</sub> =20mA) mcd		Wavelength nm λ <sub>P</sub>	Viewing Angle 2θ 1/2
				min.	typ.		
ZMDKVG45W	Red	InGaAlP	Water Clear	70	198	650	120°
	Green	InGaAlP		18	79		



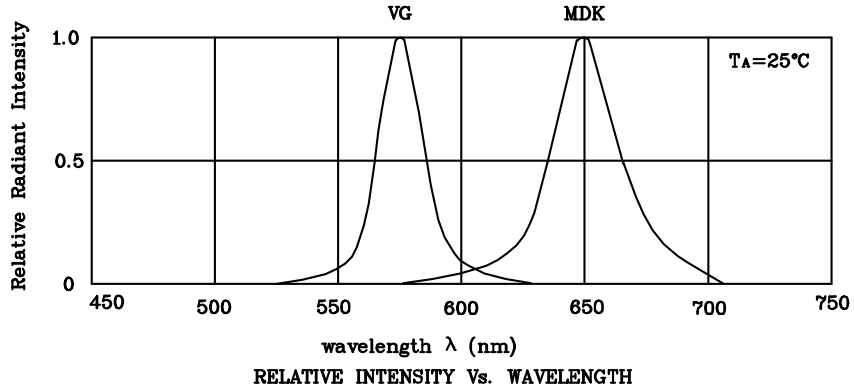

❖ MDK

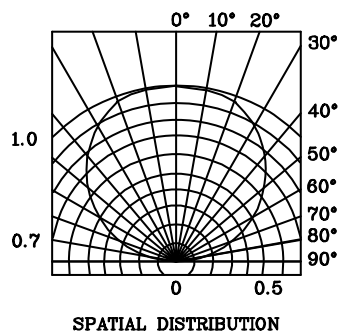
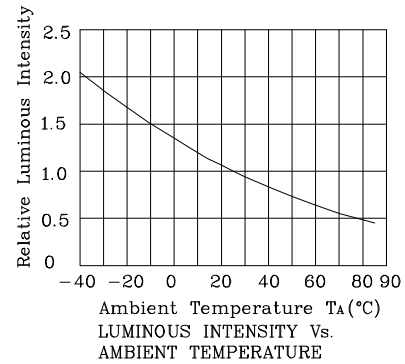
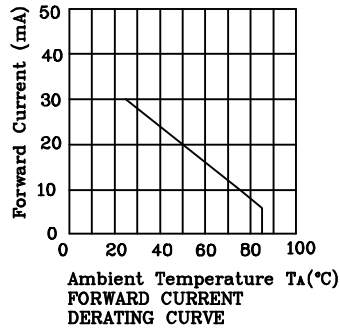
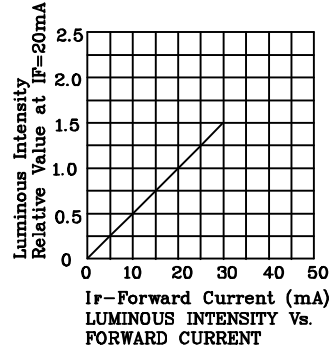
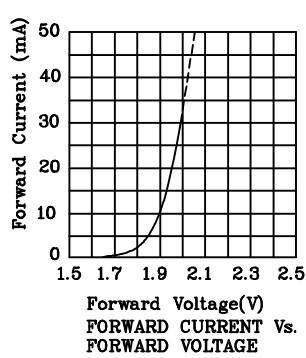

❖ VG

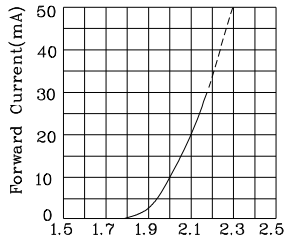

Forward Voltage(V)  
 FORWARD CURRENT Vs.  
 FORWARD VOLTAGE

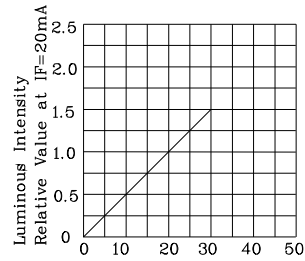

IF-Forward Current (mA)  
 LUMINOUS INTENSITY Vs.  
 FORWARD CURRENT

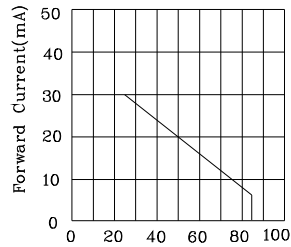

Ambient Temperature  $T_a$  (°C)  
 FORWARD CURRENT  
 DERATING CURVE

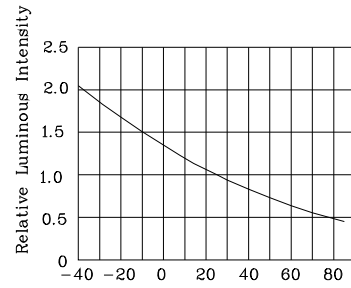

Ambient Temperature  $T_a$  (°C)  
 LUMINOUS INTENSITY Vs.  
 AMBIENT TEMPERATURE

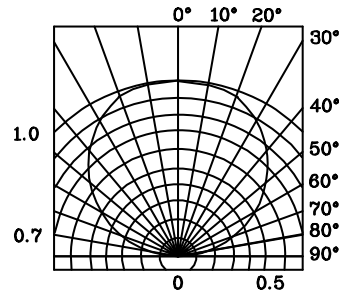

SPATIAL DISTRIBUTION

Reflow Soldering Profile For Lead-free SMT Process.

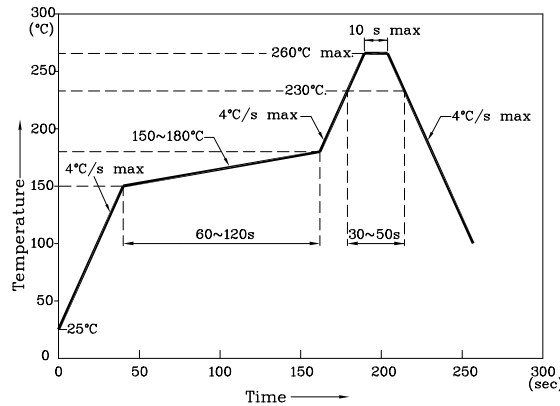

NOTES:

1. Maximum soldering temperature should not exceed 260°C.
2. Recommended reflow temperature: 145°C-260°C.
3. Do not put stress to the epoxy resin during high temperatures conditions.

❖ Recommended Soldering Pattern (Units : mm; Tolerance: ± 0.1)

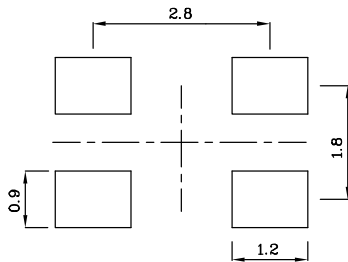

❖ The device has a single mounting surface. The device must be mounted according to the specifications.

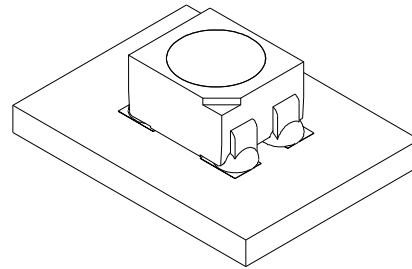

❖ Tape Specification (Units : mm)

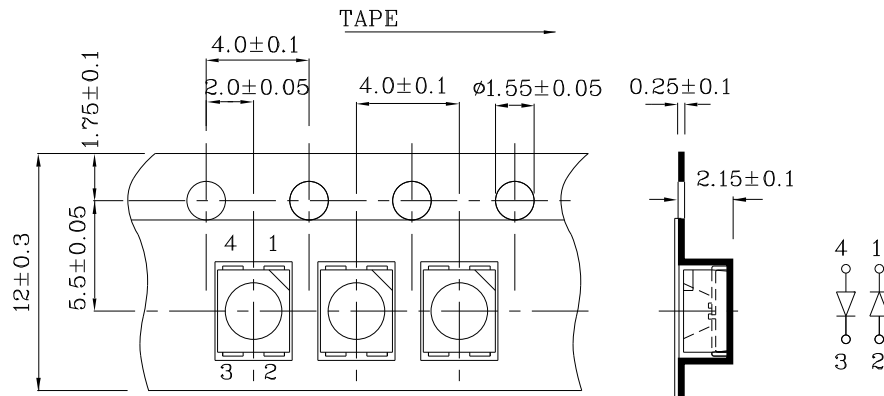

Remarks:



If special sorting is required (e.g. binning based on forward voltage, Luminous intensity / luminous flux, or wavelength), the typical accuracy of the sorting process is as follows:

1. Wavelength: +/-1nm
2. Luminous intensity / Luminous Flux: +/-15%
3. Forward Voltage: +/-0.1V

Note: Accuracy may depend on the sorting parameters.

**PACKING & LABEL SPECIFICATIONS**

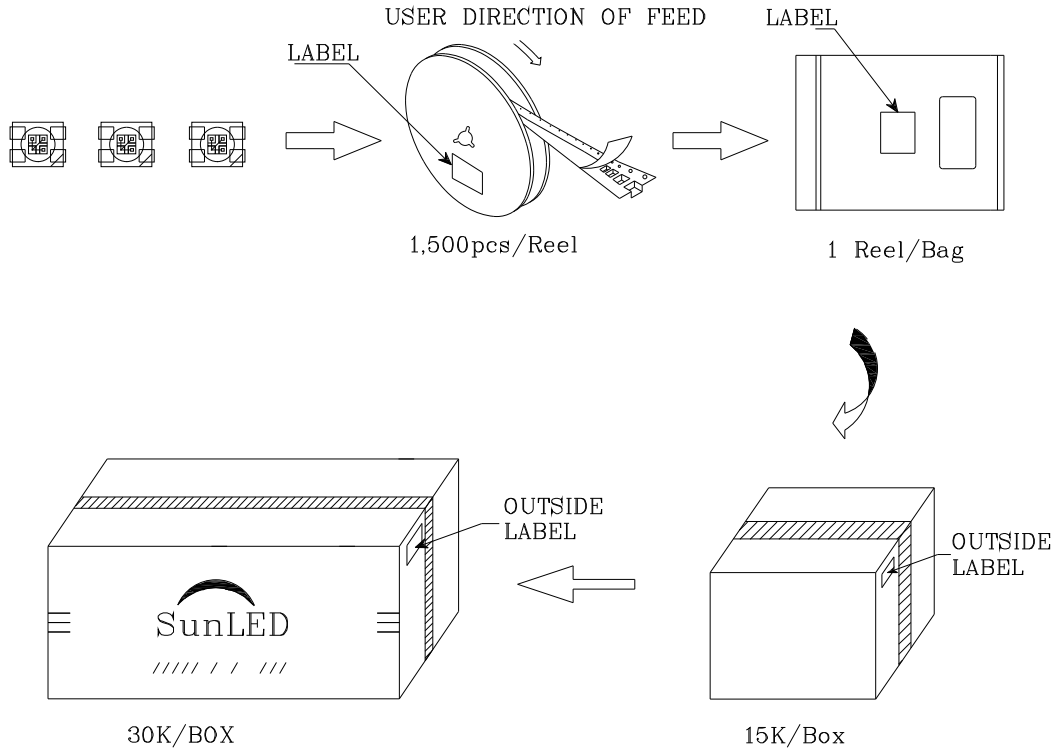
**ZMDKVG45W**

Q.C.

Q C	
XX	XX. XXXX
PASSED	

P/NO : Zxxx45x	
QTY : 1,500 pcs	CODE: XXX
S/N : XX	
LOT NO :	
 XXXXXXXXXXXXXXXXXXXXXXXXXXXX	
RoHS Compliant	