

ZN458

2.45V PRECISION REFERENCE REGULATOR

The ZN458 is a monolithic integrated circuit providing a precise stable reference source of 2.45V in a two lead package without the need for an external shaping capacitor.

FEATURES

- Guaranteed 5mV Maximum Deviation over Full Temperature Range
- Low Temperature Coefficient 0.003%/°C
- Low Slope Resistance - 0.1 Ohms
- Very Good Long Term Stability - 10ppm
- Low Noise - 10 microvolts
- Internally Shaped
- Tight Tolerance ±1.43%
- Two Pin Package
- Wide Operating Current 2-120mA

ABSOLUTE MAXIMUM RATINGS

Dissipation	300mW
Operating temperature range	-20°C to +70°C
Storage temperature range	-55°C to +150°C

ORDERING INFORMATION

Device	TC (ppm/°C)	Temperature range
ZN458	99	-20°C to +70°C
ZN458A	49	-20°C to +70°C
ZN458B	29	-20°C to +70°C

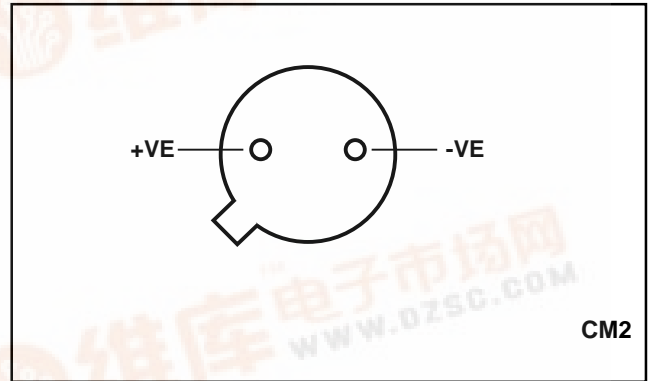

Fig.1 Pin connection - bottom view

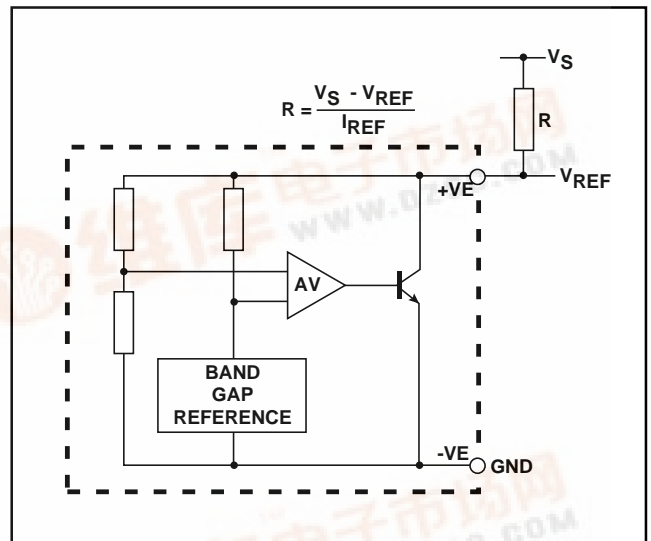

Fig.2 Circuit diagram



ZN458

ELECTRICAL CHARACTERISTICS (at $T_{amb} = 25^{\circ}\text{C}$ unless otherwise specified)

Parameter	Symbol	Min.	Typ.	Max.	Units	Test conditions
Output voltage	V_{REF}	2.42	2.45	2.49	V	Measured at 2mA
Slope resistance	R_{REF}	-	0.1	0.2	Ω	
Reference current	I_{REF}	2.0	-	120	mA	
Maximum change in V_{REF}	ΔV_{REF}	-	10	22	mV	-20 to +70°C
ZN458		-	6	11	mV	
ZN458A ZN458B		-	4	6.5	mV	
RMS noise voltage 1Hz-10kHz		-	10	-	μV	
V_{REF} drift at 70°C		-	± 10	-	ppm/1000 hours	

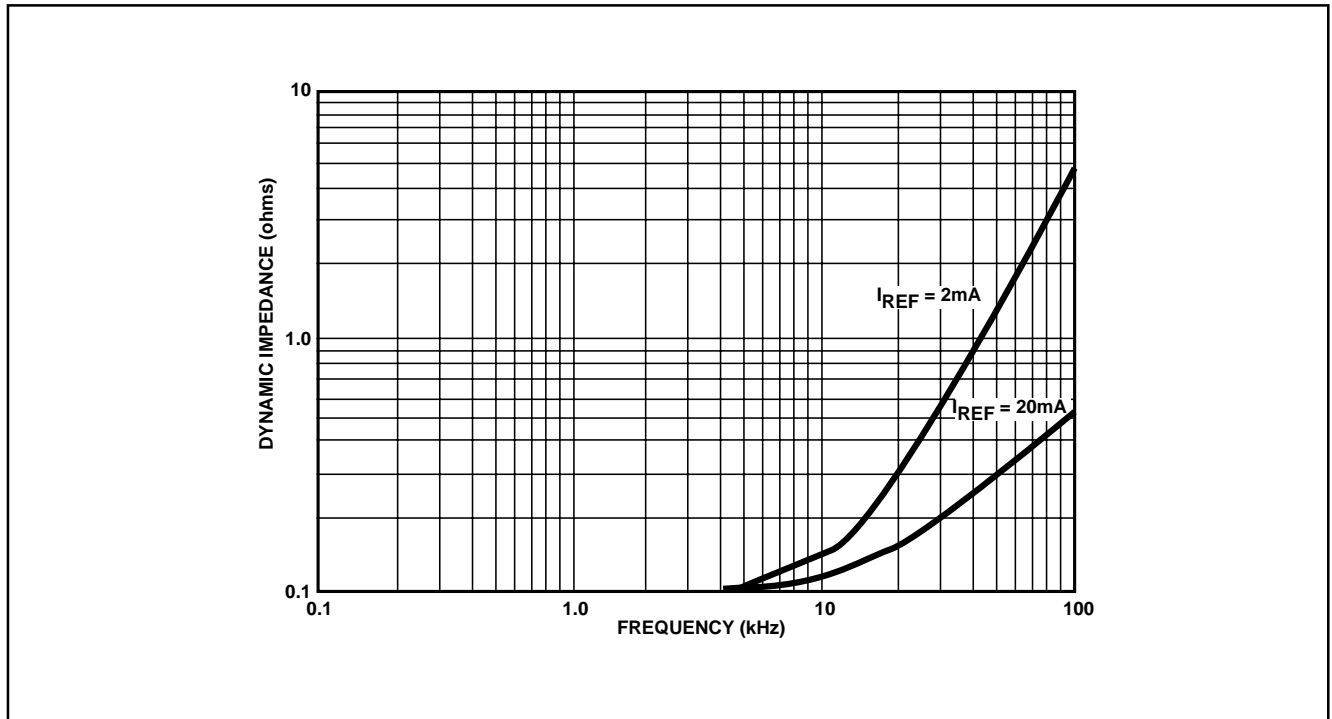

Fig.3 Dynamic impedance

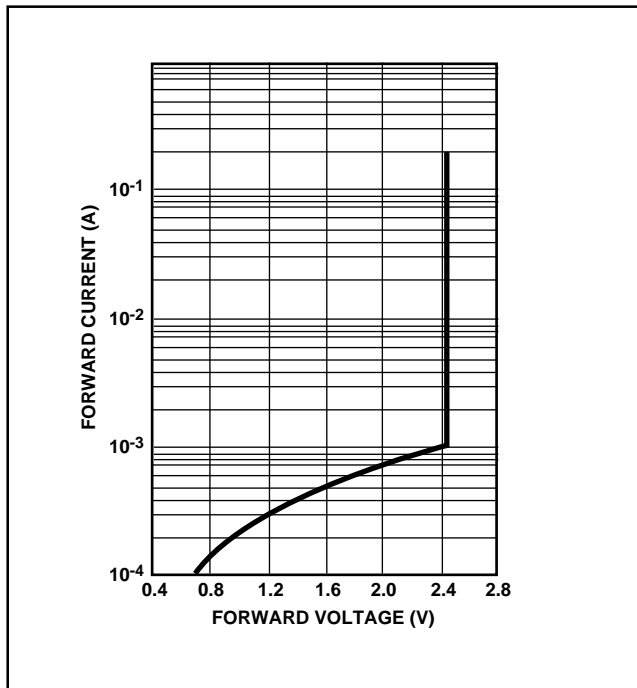

Fig.4 Forward characteristic

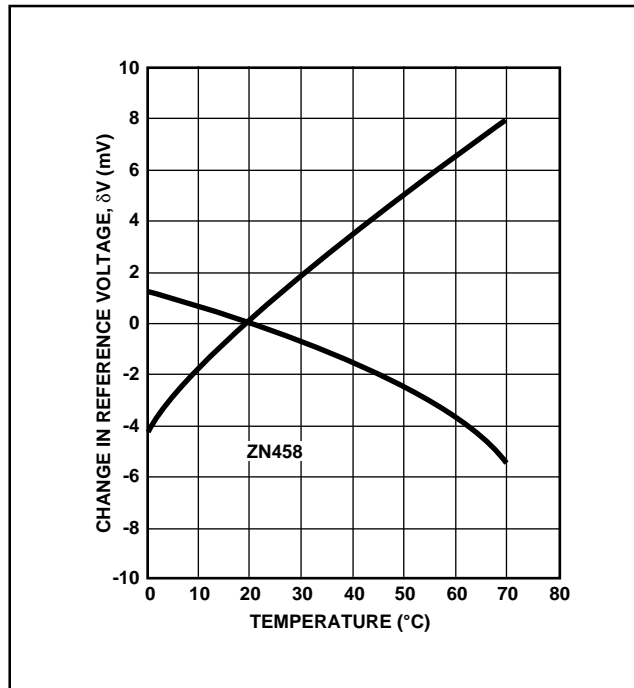

Fig.5 Temperature characteristic (typical)

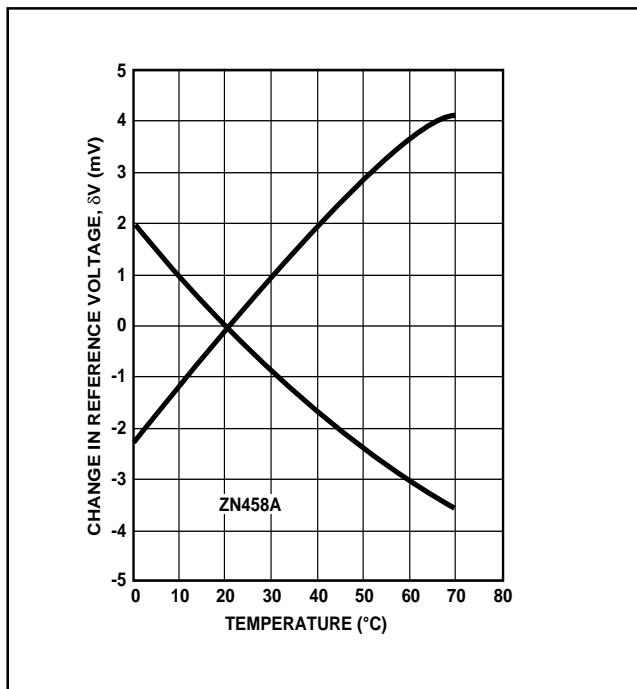

Fig.6 Temperature characteristic (typical)

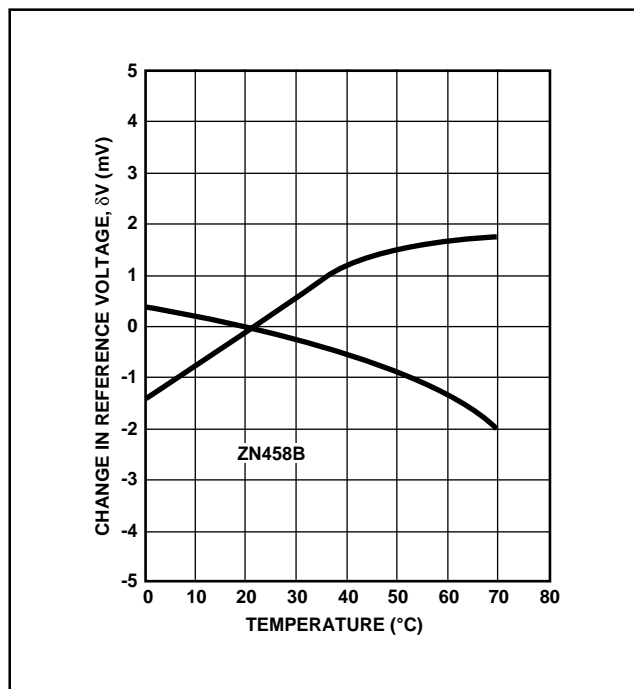

Fig.7 Temperature characteristic (typical)

ZN458

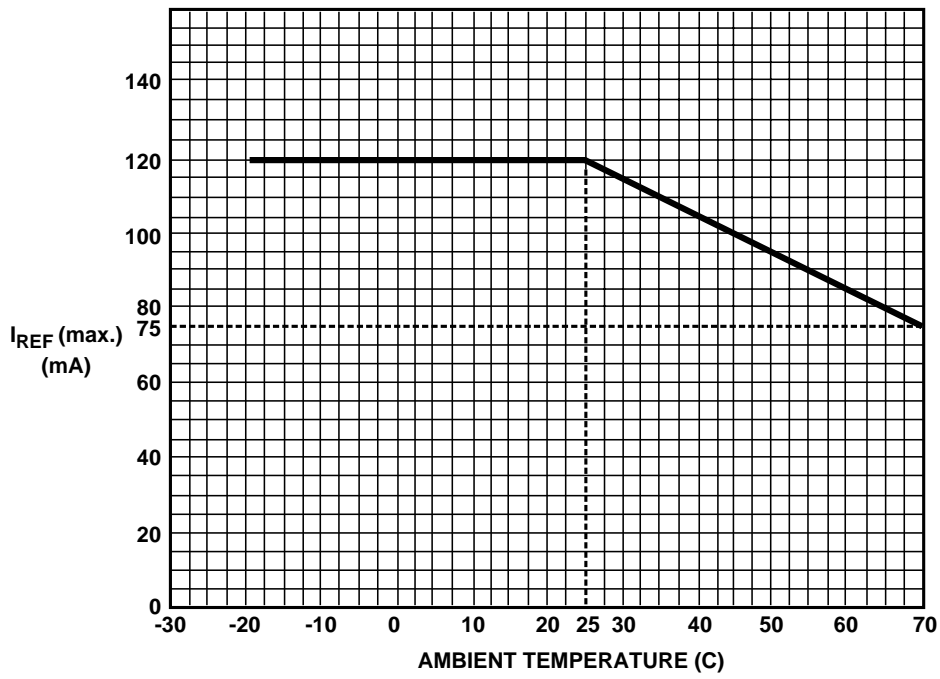

Fig.8 Derating curve

ZN458

ZN458



HEADQUARTERS OPERATIONS
GEC PLESSEY SEMICONDUCTORS
Cheney Manor, Swindon,
Wiltshire SN2 2QW, United Kingdom.
Tel: (0793) 518000
Fax: (0793) 518411

GEC PLESSEY SEMICONDUCTORS
P.O. Box 660017
1500 Green Hills Road,
Scotts Valley, California 95067-0017,
United States of America.
Tel: (408) 438 2900
Fax: (408) 438 5576

CUSTOMER SERVICE CENTRES

- **FRANCE & BENELUX** Les Ulis Cedex Tel: (1) 64 46 23 45 Fax : (1) 64 46 06 07
- **GERMANY** Munich Tel: (089) 3609 06-0 Fax : (089) 3609 06-55
- **ITALY** Milan Tel: (02) 66040867 Fax: (02) 66040993
- **JAPAN** Tokyo Tel: (03) 5276-5501 Fax: (03) 5276-5510
- **NORTH AMERICA Integrated Circuits and Microwave Products** Scotts Valley, USA
Tel (408) 438 2900 Fax: (408) 438 7023.
Hybrid Products, Farmingdale, USA Tel (516) 293 8686 Fax: (516) 293 0061.
- **SOUTH EAST ASIA** Singapore Tel: (65) 3827708 Fax: (65) 3828872
- **SWEDEN** Stockholm, Tel: 46 8 702 97 70 Fax: 46 8 640 47 36
- **UK, EIRE, DENMARK, FINLAND & NORWAY**
Swindon Tel: (0793) 518510 Fax : (0793) 518582

These are supported by Agents and Distributors in major countries world-wide.

© GEC Plessey Semiconductors 1994 Publication No. DS3025 Issue No. 2.1 January 1994

This publication is issued to provide information only which (unless agreed by the Company in writing) may not be used, applied or reproduced for any purpose nor form part of any order or contract nor to be regarded as a representation relating to the products or services concerned. No warranty or guarantee express or implied is made regarding the capability, performance or suitability of any product or service. The Company reserves the right to alter without prior knowledge the specification, design or price of any product or service. Information concerning possible methods of use is provided as a guide only and does not constitute any guarantee that such methods of use will be satisfactory in a specific piece of equipment. It is the user's responsibility to fully determine the performance and suitability of any equipment using such information and to ensure that any publication or data used is up to date and has not been superseded. These products are not suitable for use in any medical products whose failure to perform may result in significant injury or death to the user. All products and materials are sold and services provided subject to the Company's conditions of sale, which are available on request.



<http://www.mitelsemi.com>

World Headquarters - Canada

Tel: +1 (613) 592 2122

Fax: +1 (613) 592 6909

North America

Tel: +1 (770) 486 0194

Fax: +1 (770) 631 8213

Asia/Pacific

Tel: +65 333 6193

Fax: +65 333 6192

**Europe, Middle East,
and Africa (EMEA)**

Tel: +44 (0) 1793 518528

Fax: +44 (0) 1793 518581

Information relating to products and services furnished herein by Mitel Corporation or its subsidiaries (collectively "Mitel") is believed to be reliable. However, Mitel assumes no liability for errors that may appear in this publication, or for liability otherwise arising from the application or use of any such information, product or service or for any infringement of patents or other intellectual property rights owned by third parties which may result from such application or use. Neither the supply of such information or purchase of product or service conveys any license, either express or implied, under patents or other intellectual property rights owned by Mitel or licensed from third parties by Mitel, whatsoever. Purchasers of products are also hereby notified that the use of product in certain ways or in combination with Mitel, or non-Mitel furnished goods or services may infringe patents or other intellectual property rights owned by Mitel.

This publication is issued to provide information only and (unless agreed by Mitel in writing) may not be used, applied or reproduced for any purpose nor form part of any order or contract nor to be regarded as a representation relating to the products or services concerned. The products, their specifications, services and other information appearing in this publication are subject to change by Mitel without notice. No warranty or guarantee express or implied is made regarding the capability, performance or suitability of any product or service. Information concerning possible methods of use is provided as a guide only and does not constitute any guarantee that such methods of use will be satisfactory in a specific piece of equipment. It is the user's responsibility to fully determine the performance and suitability of any equipment using such information and to ensure that any publication or data used is up to date and has not been superseded. Manufacturing does not necessarily include testing of all functions or parameters. These products are not suitable for use in any medical products whose failure to perform may result in significant injury or death to the user. All products and materials are sold and services provided subject to Mitel's conditions of sale which are available on request.

M Mitel (design) and ST-BUS are registered trademarks of MITEL Corporation

Mitel Semiconductor is an ISO 9001 Registered Company

Copyright 1999 MITEL Corporation

All Rights Reserved

Printed in CANADA

TECHNICAL DOCUMENTATION - NOT FOR RESALE