

13F-2Z-A2

RELAY SOCKET



CHARACTERISTICS

Ambient temperature :	-40 °C to 70 °C
Rated voltage :	300VAC
Rated current :	15A (per pole)
Insulation voltage (Min.) :	5000VAC
Protection degree DIN40050 :	IP20
Socket material :	PBT V0 (UL)
Contacts spring material :	QSn6.5-0.1
Steel retainer :	available
White plastic tag :	non-available
Applicable relay type:	HF13F (JQX-13F) (2 poles)

DIMENSIONS, PC BOARD LAYOUT AND WIRING DIAGRAM

Unit: mm

Outline Dimensions

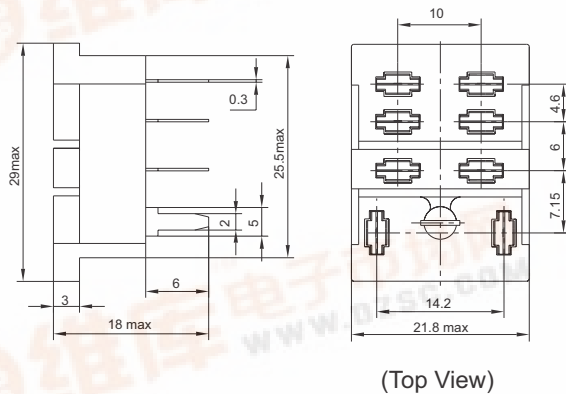

PCB Layout

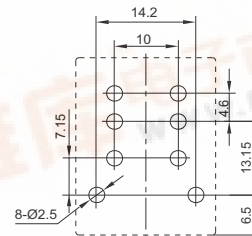

Retainer Dimensions

