

Bulletin PD-20775 06/04

International IOR Rectifier

15MQ040NPbF

SCHOTTKY RECTIFIER

3 Amp

$I_{F(AV)} = 3\text{Amp}$
 $V_R = 40\text{V}$

Major Ratings and Characteristics

Characteristics	Value	Units
I_F DC	3	A
V_{RRM}	40	V
I_{FSM} @tp = 5 μ s sine	330	A
V_F @2Apk, $T_J = 125^\circ\text{C}$	0.43	V
T_J range	-40 to 150	$^\circ\text{C}$

Description/ Features

The 15MQ040NPbF Schottky rectifier is designed to be used for low-power applications where a reverse voltage of 40 volts is encountered and surface mountable is required.

Applications

- Switching power supplies
- Meter protection
- Reverse protection for power input to PC board circuits
- Battery isolation and charging
- Low threshold voltage diode
- Free-wheeling or by-pass diode
- Low voltage clamp

Features

- Surface mountable
- Extremely low forward voltage
- Improved reverse blocking voltage capability relative to other similar size Schottky
- Compact size
- Lead-Free ("PbF" suffix)

Case Styles

15MQ040NPbF

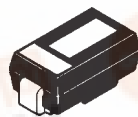

SMA

Cathode  Anode

Voltage Ratings

Part number	15MQ040NPbF
V_R Max. DC Reverse Voltage (V)	40
V_{RWM} Max. Working Peak Reverse Voltage (V)	

Absolute Maximum Ratings

Parameters	15MQ	Units	Conditions
$I_{F(AV)}$ Max. Average Forward Current * See Fig. 4	2.1	A	50% duty cycle @ $T_L = 105^\circ\text{C}$, rectangular wave form. On PC board 9mm ² island (.013mm thick copper pad area)
I_{FSM} Max. Peak One Cycle Non-Repetitive Surge Current * See Fig. 6	330	A	5 μs Sine or 3 μs Rect. pulse
	140		10ms Sine or 6ms Rect. pulse
E_{AS} Non-Repetitive Avalanche Energy	6.0	mJ	$T_J = 25^\circ\text{C}$, $I_{AS} = 1\text{A}$, $L = 12\text{mH}$
I_{AR} Repetitive Avalanche Current	1.0	A	

Electrical Specifications

Parameters	15MQ	Units	Conditions
V_{FM} Max. Forward Voltage Drop (1) * See Fig. 1	0.42	V	@ 1A
	0.49	V	@ 2A
	0.34	V	@ 1A
	0.43	V	@ 2A
I_{RM} Max. Reverse Leakage Current (1) * See Fig. 2	0.5	mA	$T_J = 25^\circ\text{C}$
	20	mA	$T_J = 125^\circ\text{C}$
$V_{F(TO)}$ Threshold Voltage	0.26	V	$T_J = T_J \text{ max.}$
r_t Forward Slope Resistance	64.6	m Ω	
C_T Typical Junction Capacitance	134	pF	$V_R = 10V_{DC}$, $T_J = 25^\circ\text{C}$, test signal = 1Mhz
L_S Typical Series Inductance	2.0	nH	Measured lead to lead 5mm from package body
dv/dt Max. Voltage Rate of Change	10000	V/ μs	(Rated V_R)

(1) Pulse Width < 300 μs , Duty Cycle < 2%

Thermal-Mechanical Specifications

Parameters	15MQ	Units	Conditions
T_J Max. Junction Temperature Range (*)	-40 to 150	$^\circ\text{C}$	
T_{stg} Max. Storage Temperature Range	-40 to 150	$^\circ\text{C}$	
R_{thJA} Max. Thermal Resistance Junction to Ambient	80	$^\circ\text{C}/\text{W}$	DC operation
wt Approximate Weight	0.07(0.002)	g (oz.)	
Case Style	SMA		Similar D-64
Device Marking	IR3F		

(*) $\frac{dP_{tot}}{dT_J} < \frac{1}{R_{th(j-a)}}$ thermal runaway condition for a diode on its own heatsink

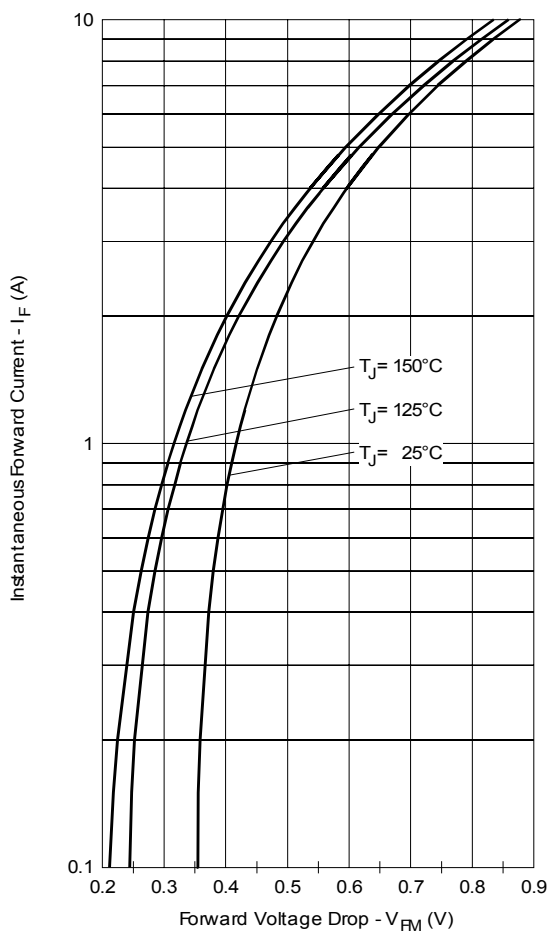

Fig. 1 - Maximum Forward Voltage Drop Characteristics

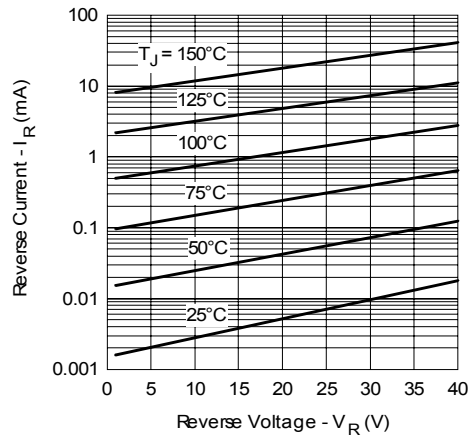

Fig. 2 - Typical Peak Reverse Current Vs. Reverse Voltage

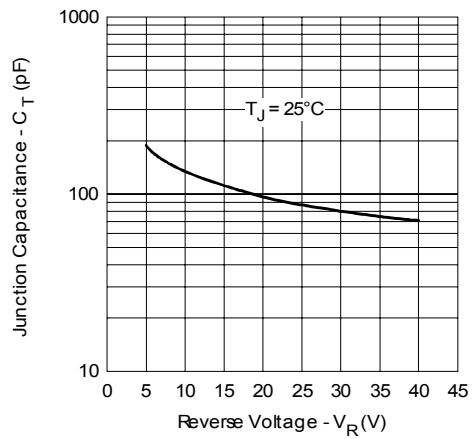

Fig. 3 - Typical Junction Capacitance Vs. Reverse Voltage

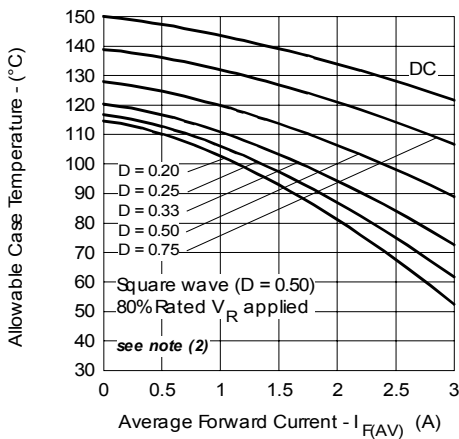

Fig. 4 - Maximum Average Forward Current Vs. Allowable Lead Temperature

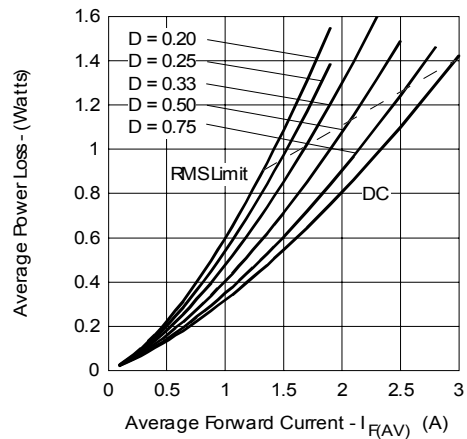

Fig. 5 - Maximum Average Forward Dissipation Vs. Average Forward Current

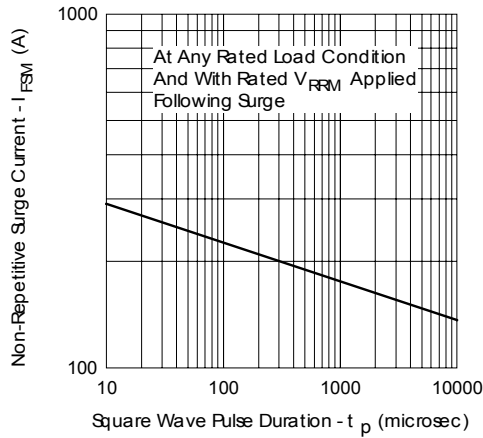

Fig. 6 - Maximum Peak Surge Forward Current Vs. Pulse Duration

(2) Formula used: $T_C = T_J - (Pd + Pd_{REV}) \times R_{thJC}$;

Pd = Forward Power Loss = $I_{F(AV)} \times V_{FM} @ (I_{F(AV)} / D)$ (see Fig. 6);

Pd_{REV} = Inverse Power Loss = $V_{R1} \times I_R (1 - D)$; $I_R @ V_{R1} = 80\%$ rated V_R

Outline Table

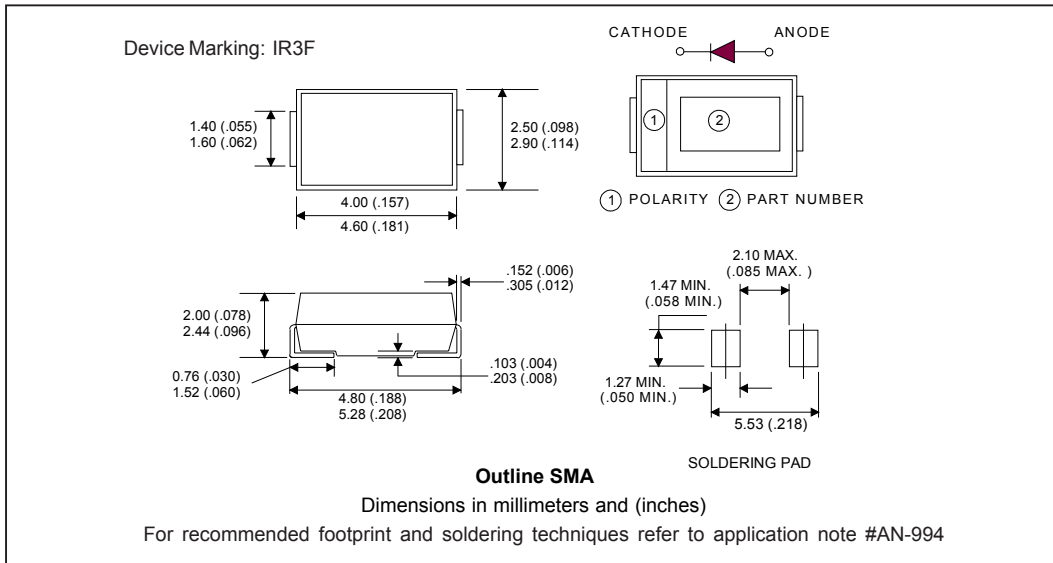

Marking & Identification

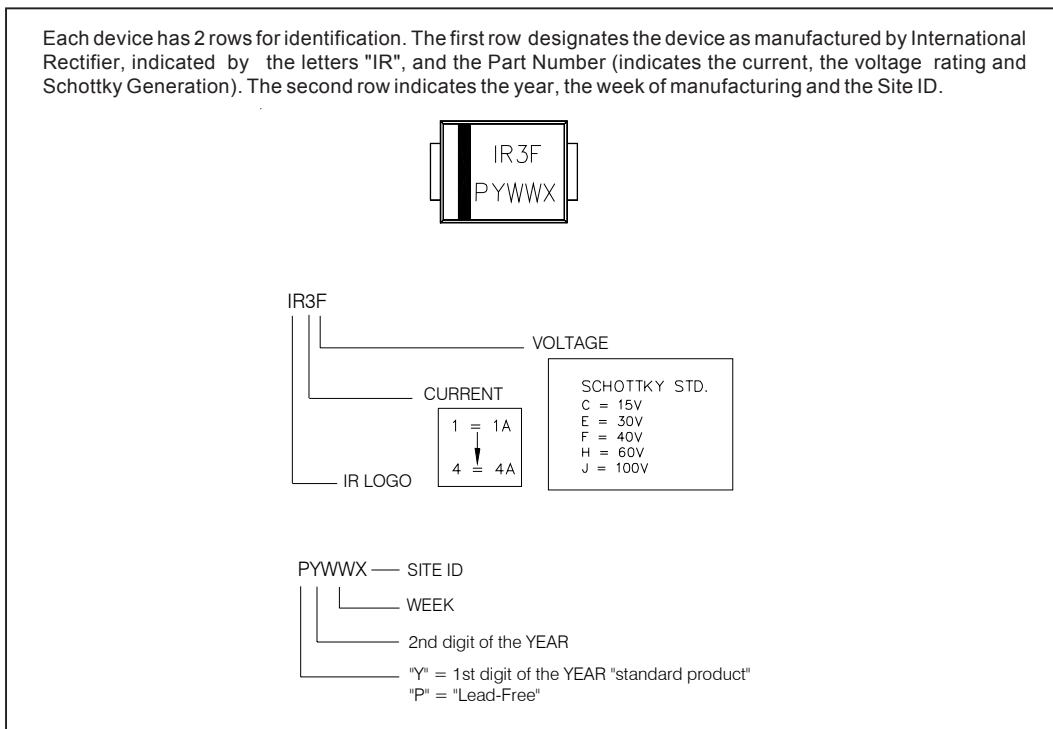

Tape & Reel Information

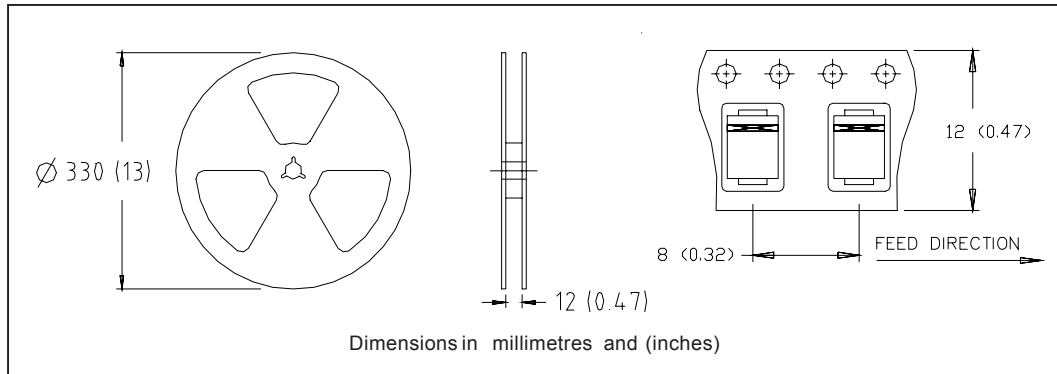

Ordering Information Table

Device Code						
15	M	Q	040	N	TR	PbF
①	②	③	④	⑤	⑥	⑦
1	- Current Rating					
2	- M = SMA					
3	- Q = Schottky Q Series					
4	- Voltage Rating (040 = 40V)					
5	- N = New SMA					
6	- • none = Box (1000 pieces) • TR = Tape & Reel (7500 pieces)					
7	- • none = Standard Production • PbF = Lead-Free					

Data and specifications subject to change without notice.
This product has been designed and qualified for Industrial Level and Lead-Free.
Qualification Standards can be found on IR's Web site.