

MOSPEC

HIGH POWER NPN SILICON POWER TRANSISTORS

High-Current, High-Speed, High-Power Type for Switching and Amplifier Applications.

FEATURES:

- * DC Current Gain $h_{FE} = 20 \sim 100 @ I_C = 15 A, V_{CE} = 2.0 V$
- * Low $V_{CE(SAT)} \leq 0.75 V @ I_C = 15A, I_B = 1.2A$
- * Maximum Safe-Area-of-Operation Curves...
 I_{sb} limit line beginning 24 V

NPN
2N5671
2N5672

30 AMPERE
SILICON POWER
TRANSISTORS
90-120 VOLTS
140 WATTS

MAXIMUM RATINGS

Characteristic	Symbol	2N5671	2N5672	Unit
Collector-Emitter Voltage	V_{CEO}	90	120	V
Collector-Base Voltage	V_{CBO}	120	150	V
Emitter-Base Voltage	V_{EBO}	7.0		V
Collector Current-Continuous	I_C	30		A
Base Current	I_B	10		A
Total Power Dissipation @ $T_C = 25^\circ C$ Derate above $25^\circ C$	P_D	140	0.8	W W/ $^\circ C$
Operating and Storage Junction Temperature Range	T_J, T_{STG}	- 65 to +200		$^\circ C$

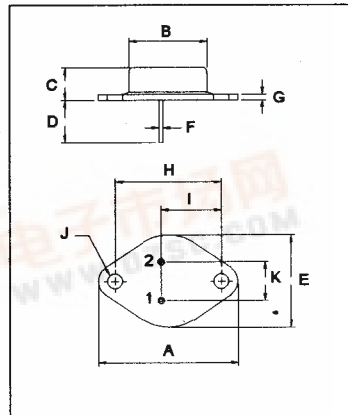
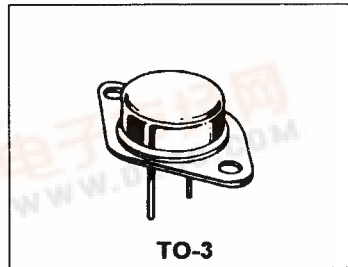

PIN 1. BASE
 2. EMITTER
 COLLECTOR (CASE)

THERMAL CHARACTERISTICS

Characteristic	Symbol	Max	Unit
Thermal Resistance Junction to Case	$R_{\theta jc}$	1.25	$^\circ C/W$

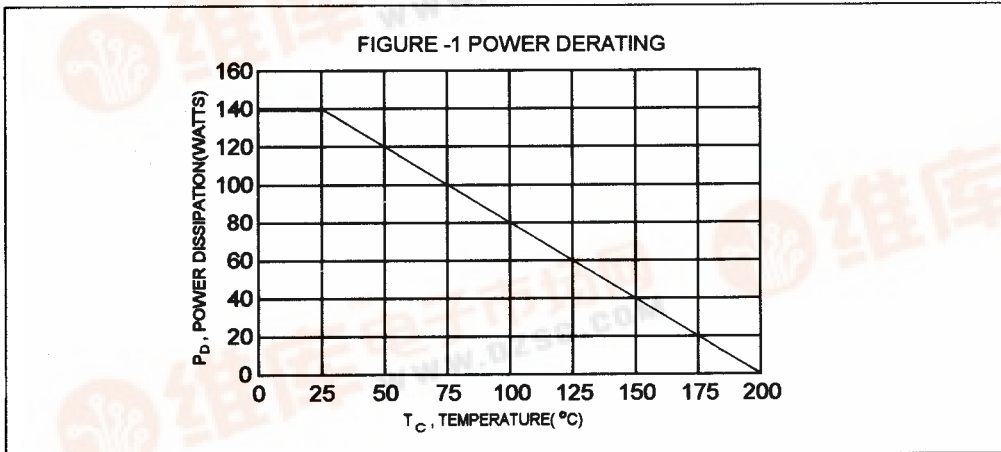

DIM	MILLIMETERS	
	MIN	MAX
A	38.75	39.96
B	19.28	22.23
C	7.96	9.28
D	11.18	12.19
E	25.20	26.67
F	0.92	1.09
G	1.38	1.62
H	29.90	30.40
I	16.64	17.30
J	3.88	4.36
K	10.67	11.18

ELECTRICAL CHARACTERISTICS ($T_c = 25^\circ\text{C}$ unless otherwise noted)

Characteristic	Symbol	Min	Max	Unit
----------------	--------	-----	-----	------

OFF CHARACTERISTICS

Collector - Emitter Sustaining Voltage (1) ($I_c = 200\text{ mA}$, $I_B = 0$) 2N5671 2N5672	$V_{CEO(sus)}$	90 120		V
Collector Cutoff Current ($V_{CE} = 80\text{ V}$, $I_B = 0$) ($V_{CE} = 80\text{ V}$, $I_B = 0$) 2N5671 2N5672	I_{CEO}		10 10	mA
Collector Cutoff Current ($V_{CE} = 110\text{ V}$, $V_{BE(off)} = 1.5\text{ V}$) ($V_{CE} = 135\text{ V}$, $V_{BE(off)} = 1.5\text{ V}$) ($V_{CE} = 100\text{ V}$, $V_{BE(off)} = 1.5\text{ V}$, $T_c = 150^\circ\text{C}$) 2N5671 2N5672 2N5671 2N5672	I_{CEV}		12 10 15 10	mA
Emitter Cutoff Current ($V_{EB} = 7.0\text{ V}$, $I_c = 0$)	I_{EBO}		10	mA

ON CHARACTERISTICS (1)

DC Current Gain ($I_c = 15.0\text{ A}$, $V_{CE} = 2.0\text{ V}$) ($I_c = 20.0\text{ A}$, $V_{CE} = 5.0\text{ V}$)	hFE	20 20	100	
Collector - Emitter Saturation Voltage ($I_c = 15.0\text{ A}$, $I_B = 1.2\text{ A}$)	$V_{CE(sat)}$		0.75	V
Base - Emitter Saturation Voltage ($I_c = 15.0\text{ A}$, $I_B = 1.2\text{ A}$)	$V_{BE(sat)}$		1.5	V
Base - Emitter On Voltage ($I_c = 15.0\text{ A}$, $V_{CE} = 5.0\text{ V}$)	$V_{BE(on)}$		1.6	V

DYNAMIC CHARACTERISTICS

Current - Gain - Bandwidth Product (2) ($I_c = 2.0\text{ A}$, $V_{CE} = 10.0\text{ V}$, $f = 1.0\text{ MHz}$)	f_T	40		MHz
--	-------	----	--	-----

SWITCHING CHARACTERISTICS

On Time	$V_{CC} = 30\text{ V}$ $I_c = 15.0\text{ A}$ $I_{B1} = -I_{B2} = 1.2\text{ A}$ $t_p = 0.1\text{ ms}$ Duty Cycle $\leq 2.0\%$	t_{on}	0.5	us
Storage Time		t_s	1.5	us
Fall Time		t_f	0.5	us

(1) Pulse Test: Pulse width = 300 us , Duty Cycle $\leq 2.0\%$

(2) $f_T = |h_{re}| \cdot f_{test}$

ACTIVE-REGION SAFE OPERATING AREA (SOA)

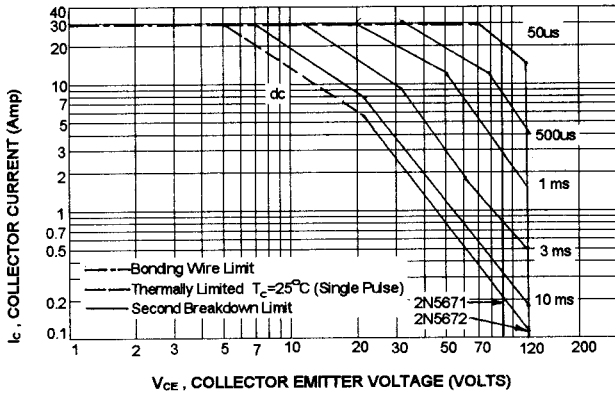

There are two limitation on the power handling ability of a transistor: average junction temperature and second breakdown safe operating area curves indicate I_C - V_{CE} limits of the transistor that must be observed for reliable operation i.e., the transistor must not be subjected to greater dissipation than curves indicate.

The data of SOA curve is base on $T_{J(PK)}=200^\circ\text{C}$; T_C is variable depending on conditions. second breakdown pulse limits are valid for duty cycles to 10% provided $T_{J(PK)} \leq 200^\circ\text{C}$. At high case temperatures, thermal limitation will reduce the power that can be handled to values less than the limitations imposed by second breakdown.

DC CURRENT GAIN

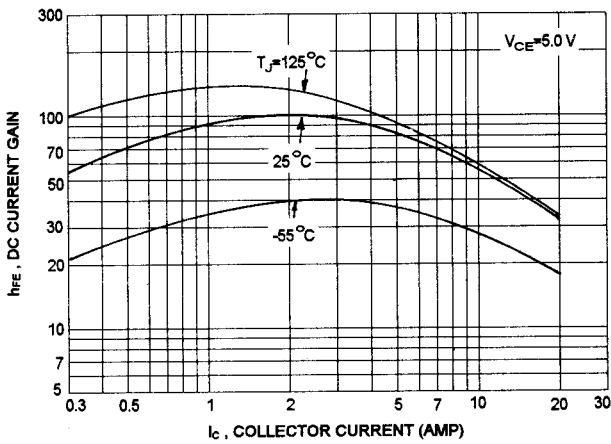

COLLECTOR SATURATION REGION

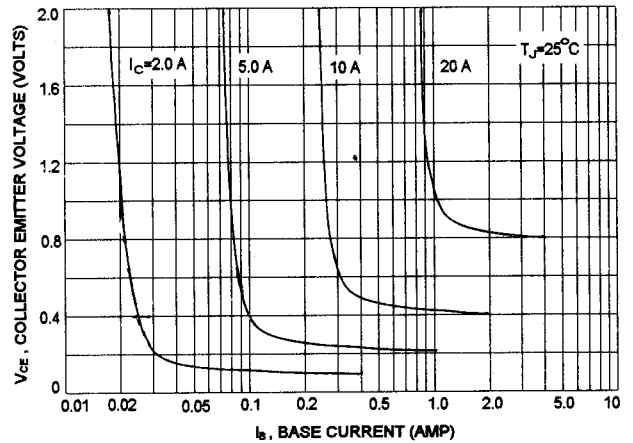

TYPICAL SWITCHING TIME

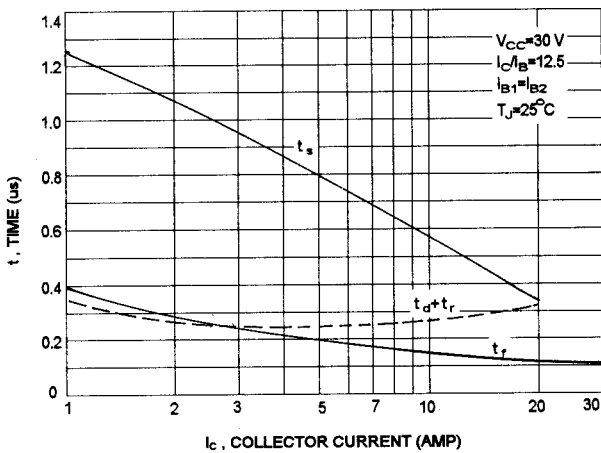

CAPACITANCES

