

BL Galaxy Electrical

Production specification

NPN Silicon Epitaxial Planar Transistor

2SC1623W

FEATURES

- High DC current gain: $h_{FE}=200$ TYP.
- High voltage: $V_{CEO}=50$ V.
- Power dissipation. ($P_C=200$ mW)



Lead-free

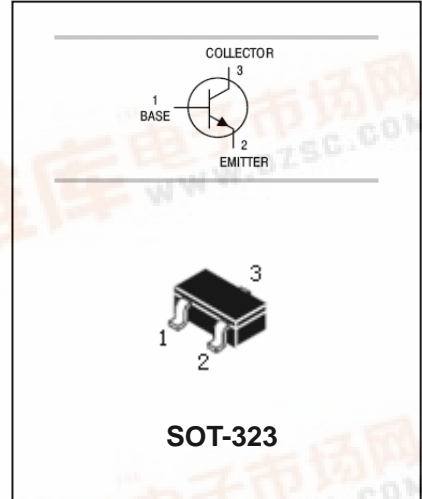

APPLICATIONS

- Audio frequency general purpose amplifier.

ORDERING INFORMATION

Type No.	Marking	Package Code
2SC1623W	L4/L5/L6/L7	SOT-323

MAXIMUM RATING @ Ta=25°C unless otherwise specified

Symbol	Parameter	Value	Units
V_{CBO}	Collector-Base Voltage	60	V
V_{CEO}	Collector-Emitter Voltage	50	V
V_{EBO}	Emitter-Base Voltage	5	V
I_C	Collector Current -Continuous	100	mA
P_C	Collector Dissipation	200	mW
T_j, T_{stg}	Junction and Storage Temperature	-55~150	°C



NPN Silicon Epitaxial Planar Transistor

2SC1623W

ELECTRICAL CHARACTERISTICS @ Ta=25°C unless otherwise specified

Parameter	Symbol	Test conditions	MIN	TYP	MAX	UNIT
Collector-base breakdown voltage	$V_{(BR)CBO}$	$I_C=100\mu A, I_E=0$	60			V
Collector-emitter breakdown voltage	$V_{(BR)CEO}$	$I_C=1mA, I_B=0$	50			V
Emitter-base breakdown voltage	$V_{(BR)EBO}$	$I_E=100\mu A, I_C=0$	6			V
Collector cut-off current	I_{CBO}	$V_{CB}=60V, I_E=0$			0.1	μA
Emitter cut-off current	I_{EBO}	$V_{EB}=5V, I_C=0$			0.1	μA
DC current gain	h_{FE}	$V_{CE}=6V, I_C=2mA$	90	200	600	
Collector-emitter saturation voltage	$V_{CE(sat)}$	$I_C=100mA, I_B=10mA$		0.15	0.3	V
Base-emitter saturation voltage	$V_{BE(sat)}$	$I_C=100mA, I_B=10mA$		0.86	1.0	V
Transition frequency	f_T	$V_{CE}=6V, I_E=-10mA$		250		MHz
Output capacitance	C_{ob}	$V_{CE}=6V, I_E=0mA$ $f=1.0MHz$		3.0		pF

CLASSIFICATION OF h_{FE}

Marking	L4	L5	L6	L7
h_{FE}	90-180	135-270	200-400	300-600

TYPICAL CHARACTERISTICS @ Ta=25°C unless otherwise specified

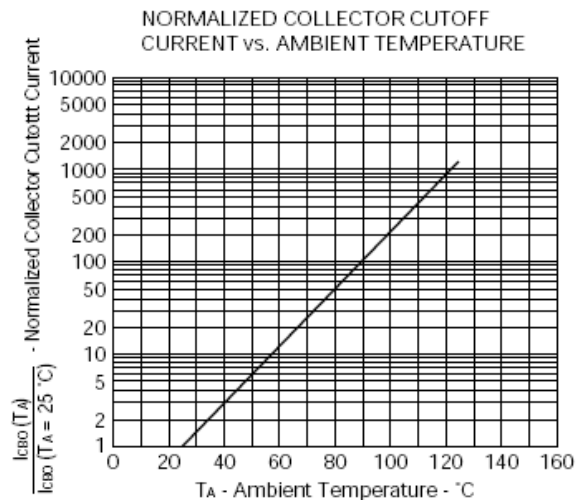
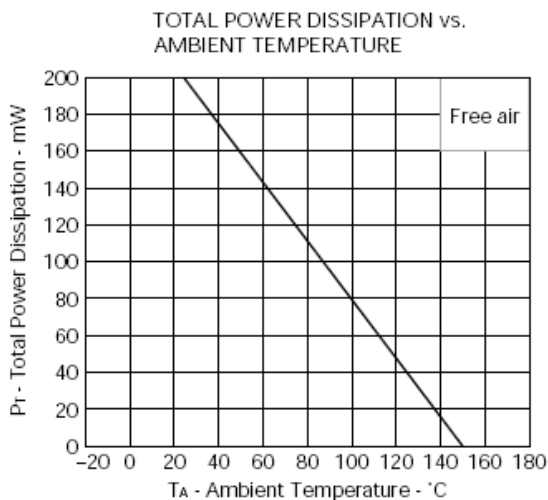

NPN Silicon Epitaxial Planar Transistor

2SC1623W

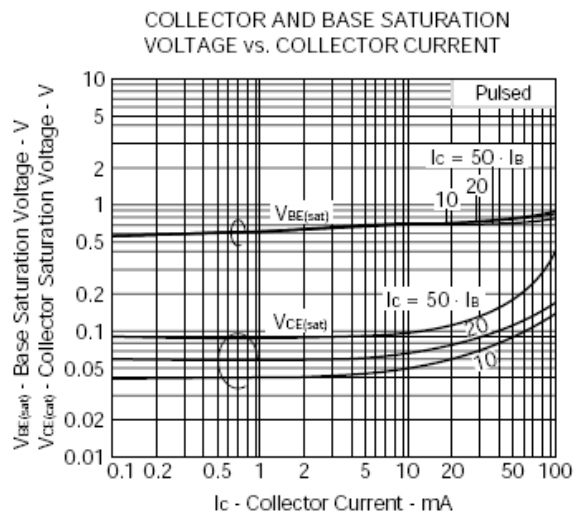
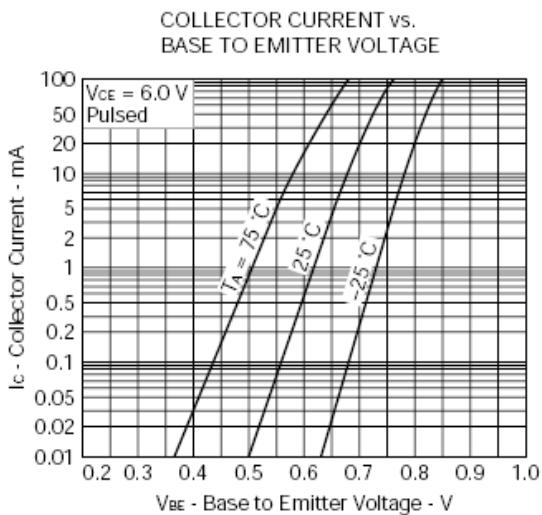
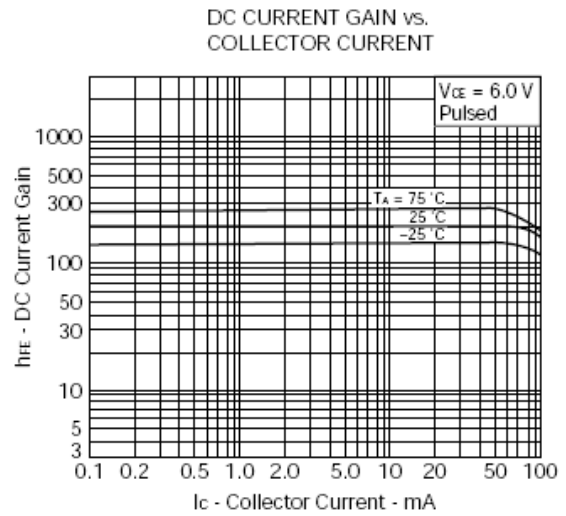
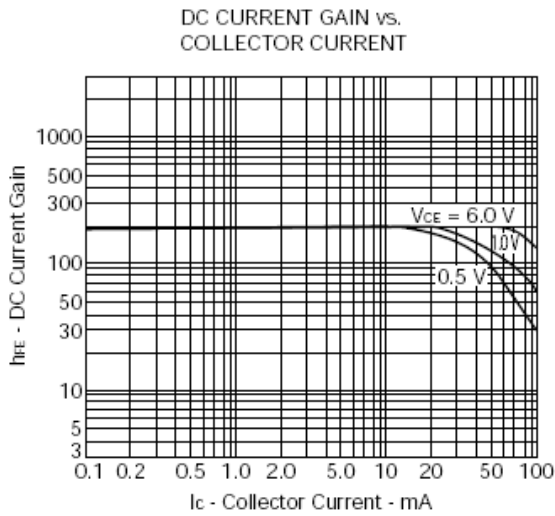
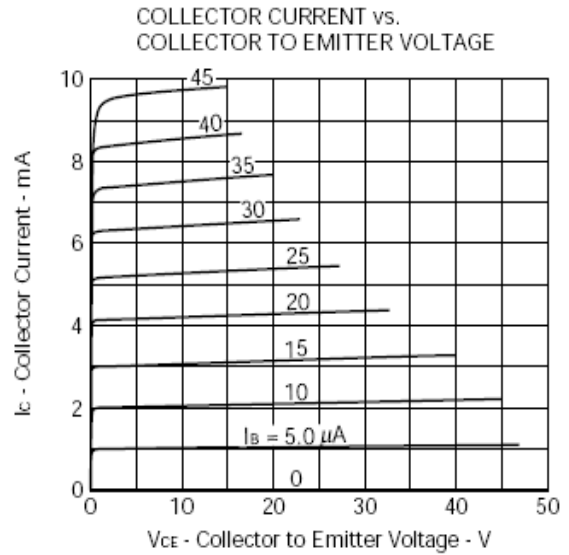
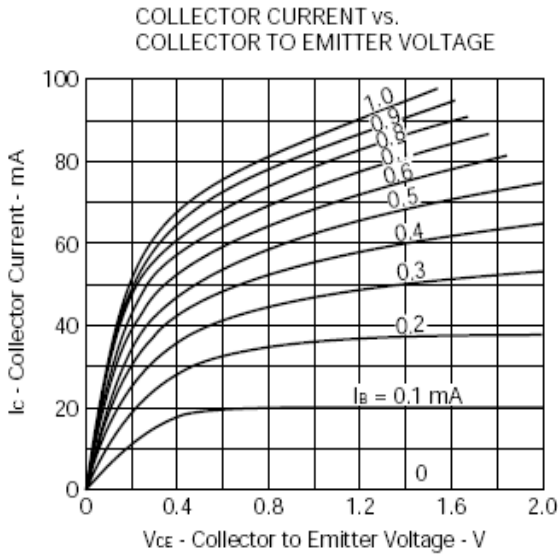

NPN Silicon Epitaxial Planar Transistor

2SC1623W

PACKAGE OUTLINE

Plastic surface mounted package

SOT-323

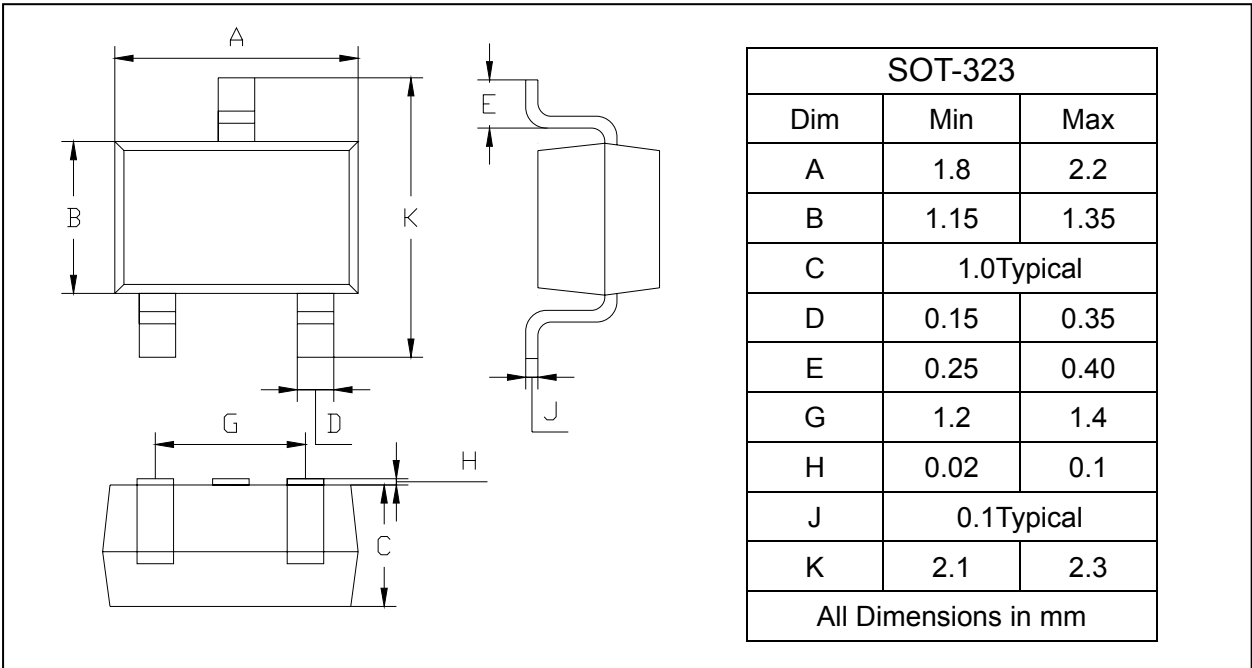

PACKAGE INFORMATION

Device	Package	Shipping
2SC1623W	SOT-323	3000/Tape&Reel