

LOW VCE (sat) 2SC4064

Silicon NPN Epitaxial Planar Transistor (Complement to type 2SA1567)

Application : DC Motor Driver and General Purpose

Absolute maximum ratings (Ta=25°C)

Symbol	2SC4064	Unit
V _{CB0}	50	V
V _{CE0}	50	V
V _{EB0}	6	V
I _C	12	A
I _B	3	A
P _C	35(T _C =25°C)	W
T _J	150	°C
T _{stg}	-55 to +150	°C

Electrical Characteristics (Ta=25°C)

Symbol	Conditions	2SC4064	Unit
I _{CB0}	V _{CB} =50V	100max	μA
I _{EB0}	V _{EB} =6V	10max	μA
V(BR) _{CEO}	I _C =25mA	50min	V
h _{FE}	V _{CE} =1V, I _C =6A	50min	
V _{CE(sat)}	I _C =6A, I _B =0.3A	0.35max	V
f _r	V _{CE} =12V, I _E =-0.5A	40typ	MHz
COB	V _{CB} =12V, f=1MHz	180typ	pF

External Dimensions FM20(TO220F)

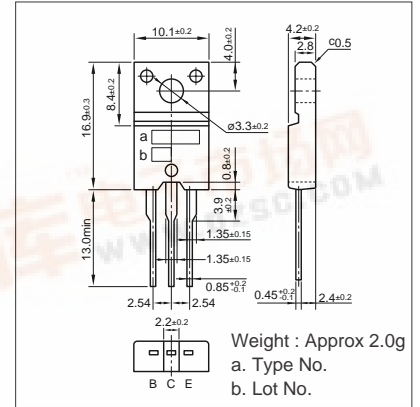

Typical Switching Characteristics (Common Emitter)

V _{CC} (V)	R _L (Ω)	I _C (A)	V _{BB1} (V)	V _{BB2} (V)	I _{B1} (A)	I _{B2} (A)	t _{on} (μs)	t _{stg} (μs)	t _f (μs)
24	4	6	10	-5	0.12	-0.12	0.6typ	1.4typ	0.4typ

I_C-V_{CE} Characteristics (Typical)

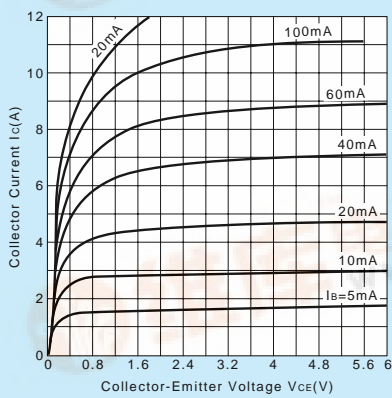

V_{CE(sat)}-I_B Characteristics (Typical)

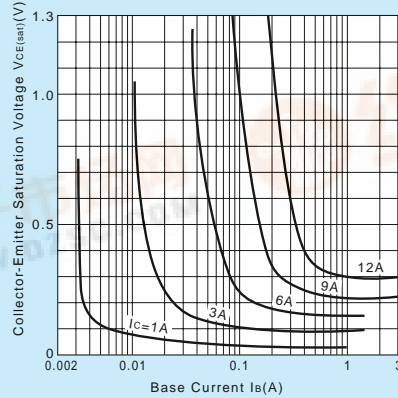

I_C-V_{BE} Temperature Characteristics (Typical)

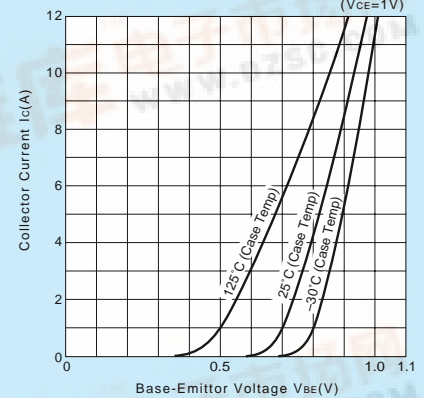

h_{FE}-I_C Characteristics (Typical)

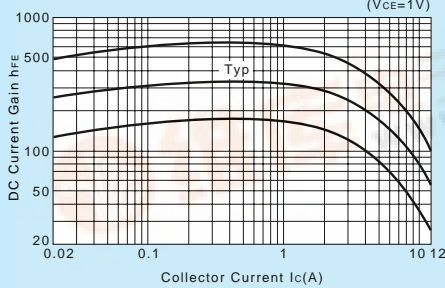

h_{FE}-I_C Temperature Characteristics (Typical)

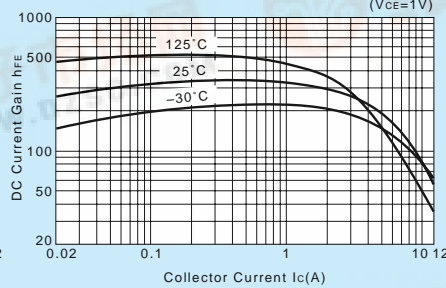

θ_{j-a-t} Characteristics

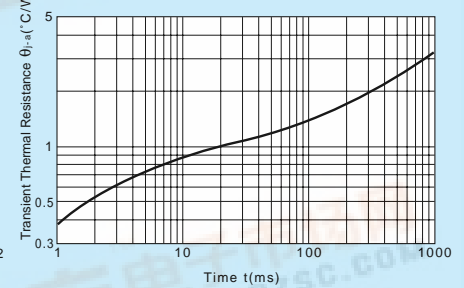

f_T-I_E Characteristics (Typical)

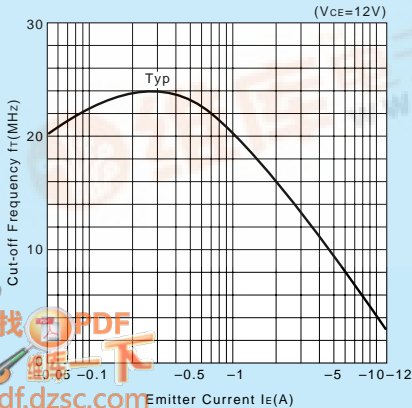

Safe Operating Area (Single Pulse)

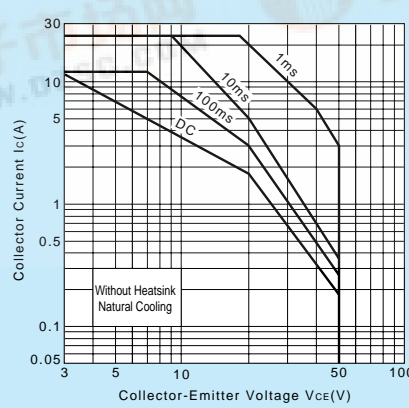

P_C-T_a Derating

