

 <p><b>FUJITSU</b></p>	<h1>SILICON HIGH SPEED POWER TRANSISTORS</h1>	<h2>2SC2429</h2>
---	---	------------------

Preliminary Specification October 1979

### SILICON NPN RING EMITTER TRANSISTOR (RET)

The 2SC2429 is a silicon NPN planer general purpose, high power switching transistor fabricated with Fujitsu's unique Ring Emitter Transistor (RET) technology. RET devices are constructed with multiple emitters connected through diffused ballast resistors which provide uniform current density. This structure permits the design of high power transistors with superior switching characteristics and frequency response in high current applications.

The 2SC2429 is especially well-suited for high speed/high voltage switching systems or other applications where large SOA is required.

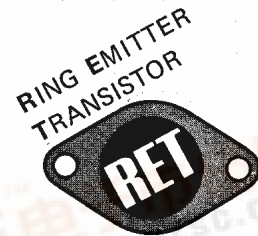

#### Features

- ★ High voltage  $V_{CEO(SUS)} = 400\text{ V}$
- ★ Continuous collector current  $I_C = 15\text{ A}$
- ★ Ultra-fast switching .....  $t_r = 150\text{ nsec}$   
 $t_s = 1200\text{ nsec}$
- ★ Large safe operating area  $t_f = 100\text{ nsec}$
- $V_{CEX(SUS)} = 450\text{ V @ } 8\text{ A}$
- ★ High  $f_T = 35\text{ MHz}$

#### Applications

- High speed switching
- ★ Converters and inverters
- ★ Class C and D amplifiers

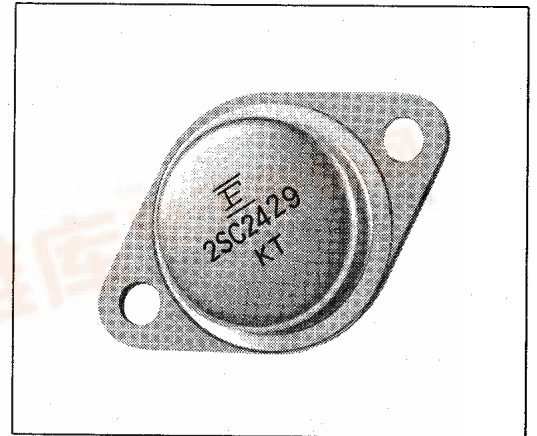

#### ABSOLUTE MAXIMUM RATINGS

Rating	Symbol	Value	Unit
Collector to Emitter Voltage	$V_{CEO}$	400	V
Collector to Base Voltage	$V_{CBO}$	450	V
Emitter to Base Voltage	$V_{EBO}$	7	V
Collector Current-Continuous	$I_C$	15	A
Collector Current-Pulse	$I_C$	20	A
Base Current-Continuous	$I_B$	5	A
Collector Power Dissipation ( $T_C = 25^\circ\text{C}$ )	$P_C$	150	W
Junction Temperature	$T_j$	+175	$^\circ\text{C}$
Storage Temperature Range	$T_{stg}$	-65 ~ +175	$^\circ\text{C}$



# 2SC2429 SILICON HIGH SPEED POWER TRANSISTORS

## ELECTRICAL CHARACTERISTICS ( $T_a = 25^\circ\text{C}$ )

Parameter	Symbol	Test Conditions	Limits			Unit
			Min.	Typ.	Max.	
Collector to Emitter Breakdown Voltage	$V_{CEO(sus)}$	$I_C = 1\text{ A}, R_{BE} = \infty$	400	—	—	V
Emitter to Base Breakdown Voltage	$V_{EBO}$	$I_E = 1\text{ mA}, I_C = 0$	7	—	—	V
Collector Cutoff Current	$I_{CBO}$	$V_{CB} = 450\text{ V}, I_E = 0$	—	—	100	$\mu\text{A}$
Emitter Cutoff Current	$I_{EBO}$	$V_{EB} = 6\text{ V}, I_C = 0$	—	—	100	$\mu\text{A}$
DC Current Gain	$h_{FE}^*$	$V_{CE} = 5\text{ V}, I_C = 10\text{ A}$	10	15	40	—
Collector to Emitter Saturation Voltage	$V_{CE(sat)}^*$	$I_C = 10\text{ A}, I_B = 2\text{ A}$	—	0.45	1.0	V
Base to Emitter Saturation Voltage	$V_{BE(sat)}^*$		—	1.2	2.0	V
Gain-Bandwidth Product	$f_T$	$V_{CE} = 10\text{ V}, I_C = 2\text{ A}, f = 10\text{ MHz}$	—	35	—	MHz
Output Capacitance	$C_{ob}$	$V_{CB} = 10\text{ V}, I_E = 0, f = 1\text{ MHz}$	—	230	—	pF
Rise Time	$t_r$	$V_{CC} = 150\text{ V}$ $I_C = 10\text{ A}$ $I_{B1} = -I_{B2} = 2\text{ A}$	—	0.15	0.5	$\mu\text{s}$
Storage Time	$t_{stg}$		—	1.20	2.5	$\mu\text{s}$
Fall Time	$t_f$		—	0.10	0.3	$\mu\text{s}$
Collector to Emitter Breakdown Voltage	$V_{CEX(sus)}$	$I_C = 8\text{ A}, I_{B2} = -1\text{ A}, L = 200\text{ }\mu\text{H}$ Pulsed, Clamped	450	—	—	V

\* Pulsed: Pulse width  $\leq 300\text{ }\mu\text{s}$   
Duty ratio  $\leq 6\%$

## TYPICAL CHARACTERISTICS ( $T_a = 25^\circ\text{C}$ )

### Switching Time

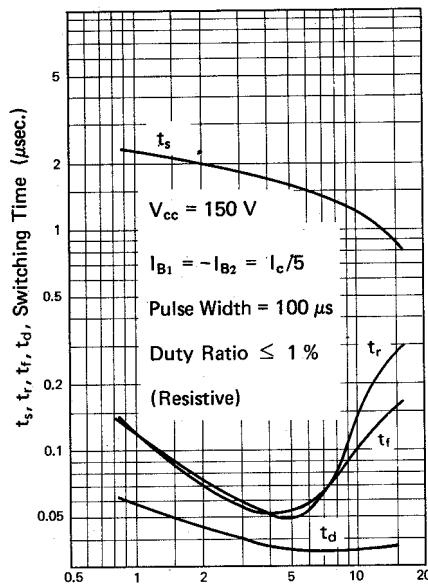

### Test Circuit used for Measurement of Switching Time

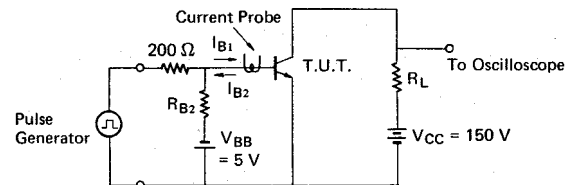

### Test Circuit used for Measurement of Reverse Bias SOA and $V_{CEX(sus)}$

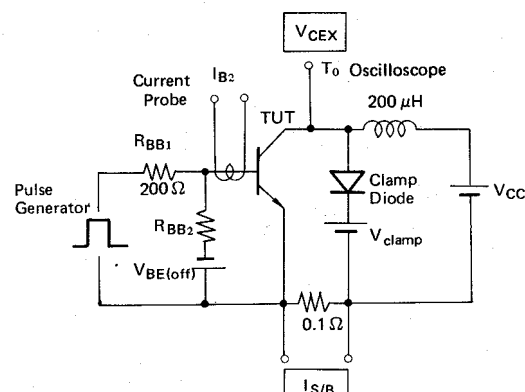

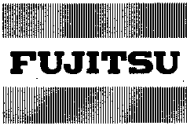

# 2SC2429 SILICON HIGH SPEED POWER TRANSISTORS

## OUTLINE DIMENSION JEDEC TO-3

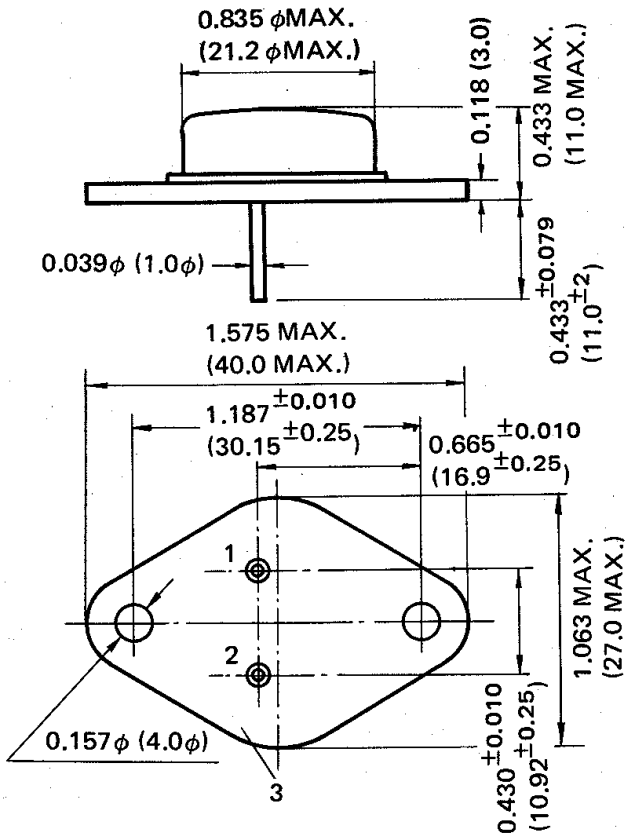

1: Emitter 2: Base 3: Collector (Case)  
Dimension in inches and (millimeters)