

2SC3085



2017

NPN Triple Diffused Planar Silicon Transistor

T-33-15

Switching Regulator Applications

©1055A

Features

- High breakdown voltage ($V_{CBO} \geq 500V$)
- Fast switching speed.
- Wide ASO.

Absolute Maximum Ratings at $T_a=25^\circ C$

Parameter	Symbol	Value	unit
Collector to Base Voltage	V_{CBO}	500	V
Collector to Emitter Voltage	V_{CEO}	400	V
Emitter to Base Current	V_{EBO}	7	V
Collector Current	I_C	25	A
Peak Collector Current	i_{cp}	40	A
PW \leq 300us, Duty Cycle \leq 10%			
Base Current	I_B	8	A
Collector Dissipation	P_C	160	W
Junction Temperature	T_j	150	$^\circ C$
Storage Temperature	T_{stg}	-55 to +150	$^\circ C$

Electrical Characteristics at $T_a=25^\circ C$

Parameter	Symbol	Test Conditions	min	typ	max	unit
Collector Cutoff Current	I_{CBO}	$V_{CB}=400V, I_E=0$			10	μA
Emitter Cutoff Current	I_{EBO}	$V_{EB}=5V, I_C=0$			10	μA
DC Current Gain	$h_{FE}(1)$	$V_{CE}=5V, I_C=3.2A$	15*		50*	
		$V_{CE}=5V, I_C=16A$	8			
Gain Bandwidth Product	f_T	$V_{CE}=10V, I_C=3.2A$		20		MHz
		$V_{CB}=10V, f=1MHz$		320		pF
C-E Saturation Voltage	$V_{CE(sat)}$	$I_C=16A, I_B=3.2A$		1.0		V
B-E Saturation Voltage	$V_{BE(sat)}$	$I_C=16A, I_B=3.2A$		1.5		V
C-B Breakdown Voltage	$V_{(BR)CBO}$	$I_C=1mA, I_E=0$		500		V
C-E Breakdown Voltage	$V_{(BR)CEO}$	$I_C=10mA, R_{BG}=\infty$		400		V
E-B Breakdown Voltage	$V_{(BR)EBO}$	$I_E=1mA, I_C=0$		7		V
C-E Sustain Voltage	$V_{CEO(sus)}$	$I_C=25A, L=50\mu H, I_B=5A$		400		V
C-E Sustain Voltage	$V_{CEX(sus)}$	$I_C=25A, I_{B1}=5A, L=200\mu H, I_{B2}=-5A, clamped$		400		V
C-E Sustain Voltage	$V_{CEX(sus)}$	$I_C=6A, I_{B1}=1.2A, L=200\mu H, I_{B2}=-1.2A, clamped$		450		V

*: The $h_{FE}(1)$ of the 2SC3085 is classified by 3.2A h_{FE} as follows. When specifying the $h_{FE}(1)$ rank, specify two ranks or more in principle.

15	L	30	20	M	40	30	N	50
----	---	----	----	---	----	----	---	----

Case Outline 2017 (unit:mm)

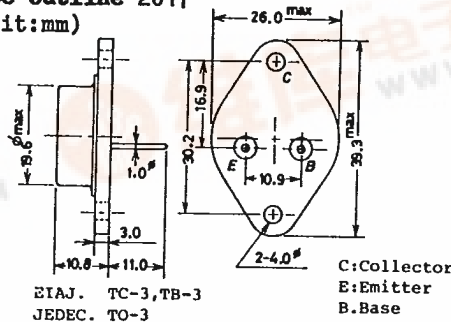

4207KI/2125MW, TS No. 1055-1/3

2SC3085

T-33-15

			min	typ	max	unit
Turn-ON Time	t_{on}	$I_C=20A, I_{B1}=4A, I_{B2}=-4A,$ $R_L=10\Omega, V_{CC}=200V$			1.0	us
Storage Time	t_{stg}	" "			2.5	us
Fall Time	t_f	" "			1.0	us

Switching Time Test Circuit

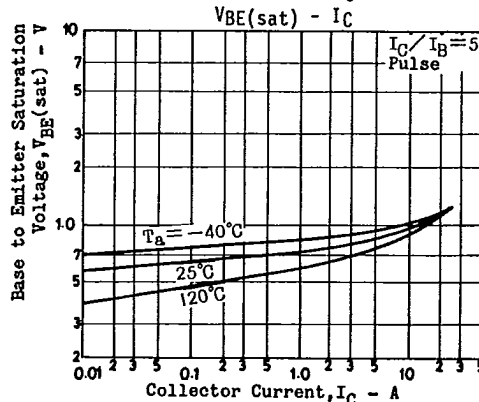
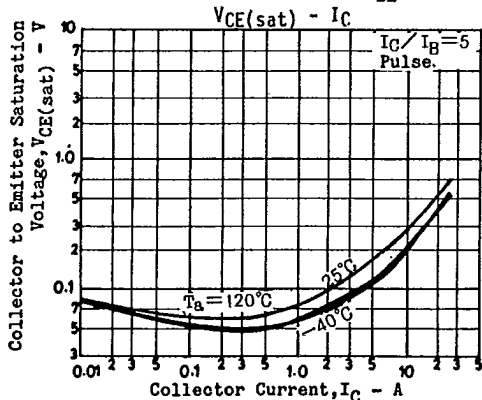
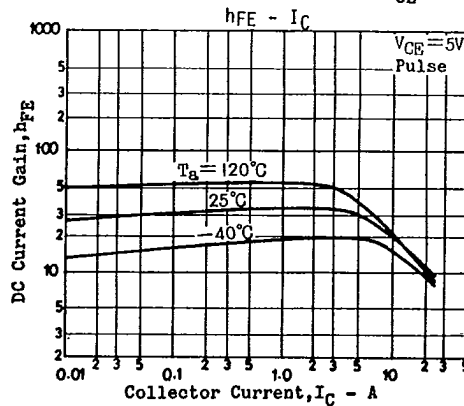
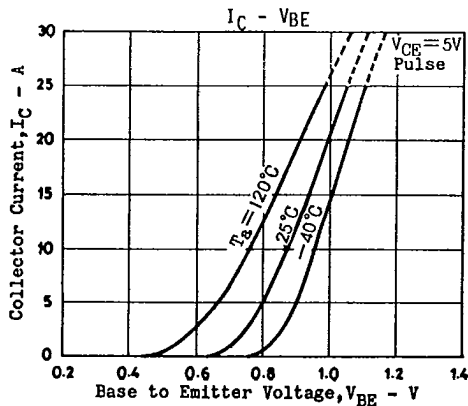
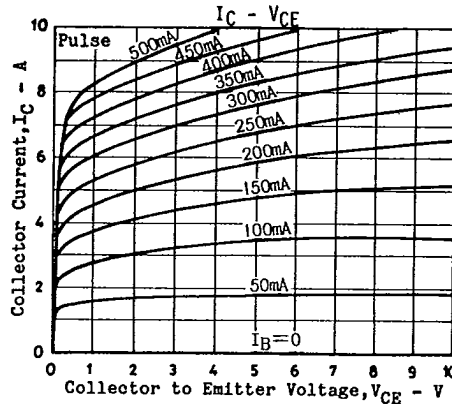
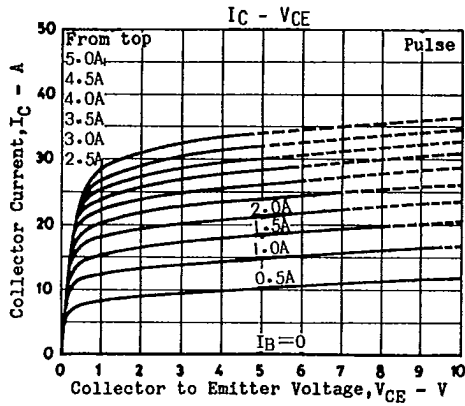
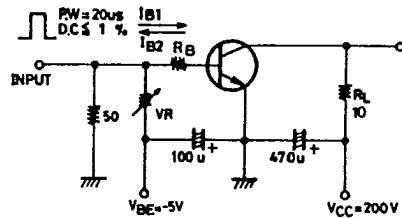

2SC3085

T-33-15

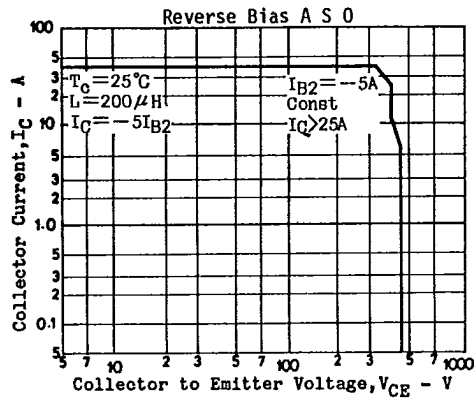
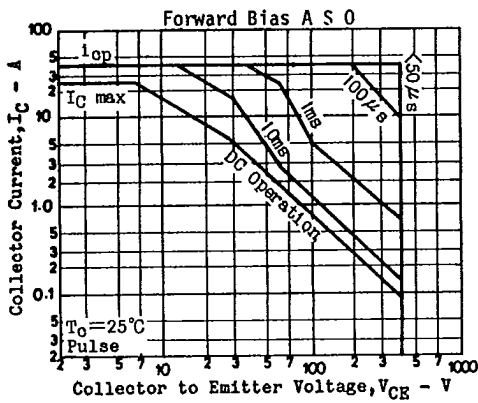
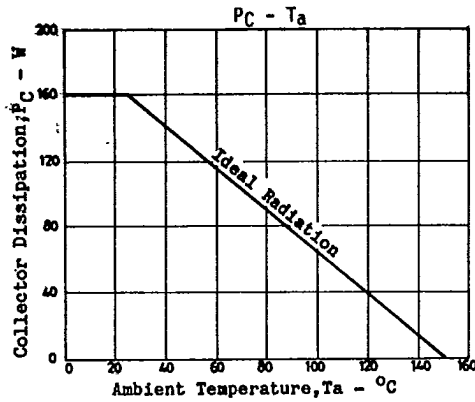
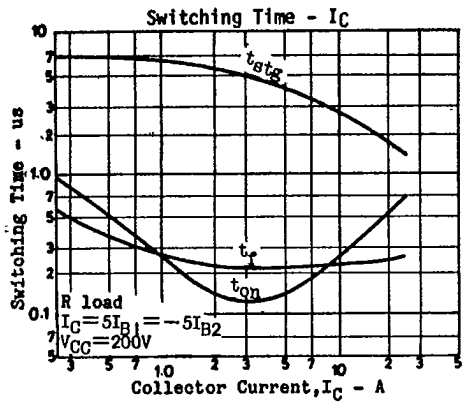

CASE OUTLINES AND ATTACHMENTS

- All of Sanyo Transistor case outlines are illustrated below.
- All dimensions are in mm, and dimensions which are not followed by min. or max. are represented by typical values.
- No marking is indicated.

Case Outline—[2003A]
unit:mm

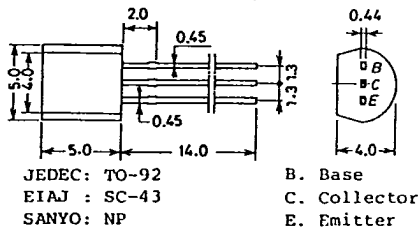

Case Outline—[2009A]
unit:mm

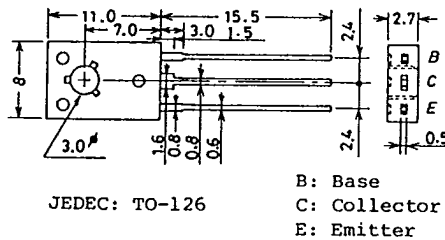

Case Outline—[2004A]
unit:mm

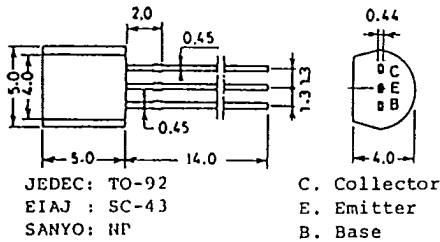

Case Outline—[2010A]
unit:mm

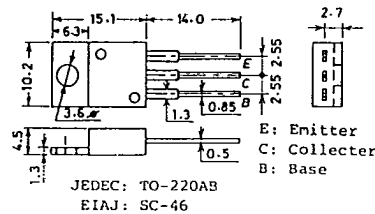

Case Outline—[2005A]
unit:mm

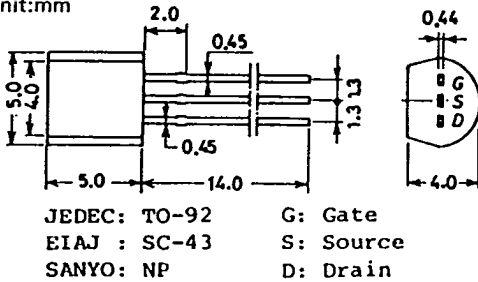

Case Outline—[2012]
unit:mm

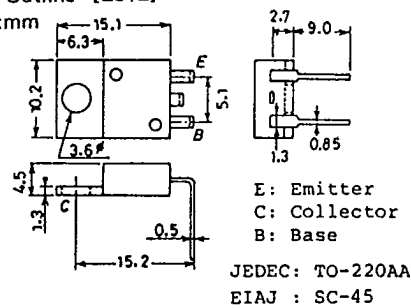

Case Outline—[2006A]
unit:mm

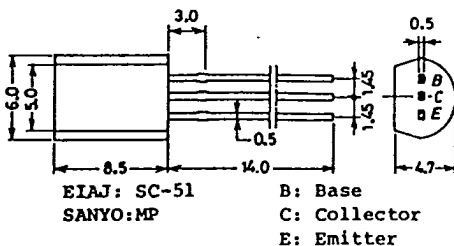

Case Outline—[2013]
unit:mm

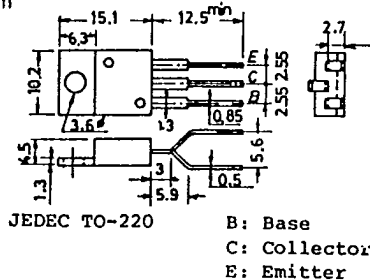

Case Outline-[2017]
unit:mm

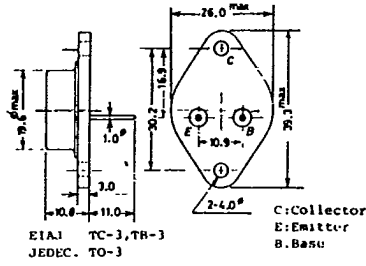

Case Outline-[2025]
unit:mm

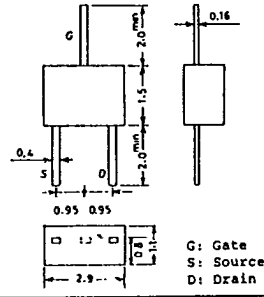

Case Outline-[2018A]
unit:mm

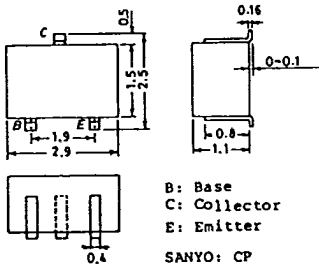

Case Outline-[2026]
unit:mm

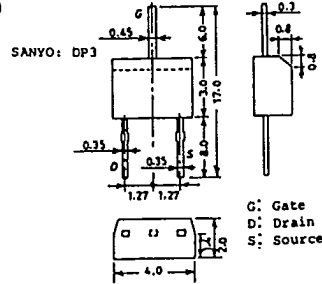

Case Outline-[2019A]
unit:mm

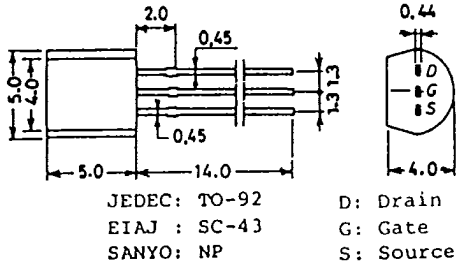

Case Outline-[2027A]
unit:mm

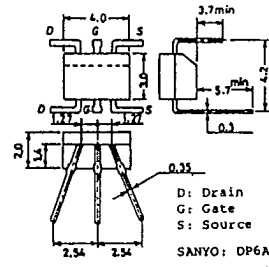

Case Outline-[2022]
unit:mm

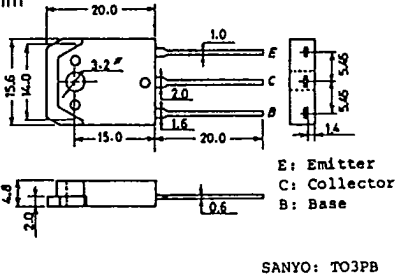

Case Outline-[2028A]
unit:mm

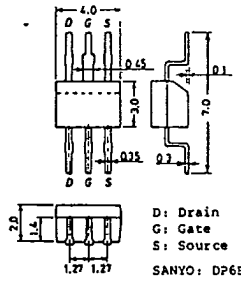

Case Outline-[2024A]
unit:mm

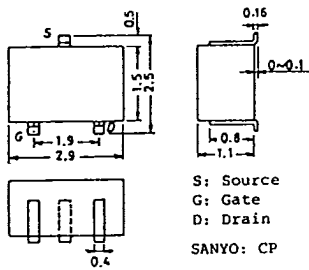

Case Outline-[2029A]
unit:mm

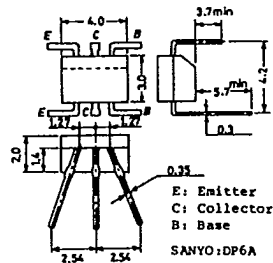

T-91-20

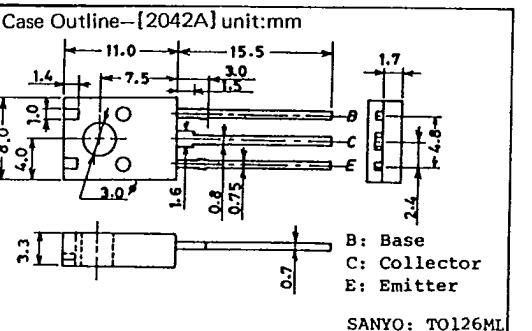
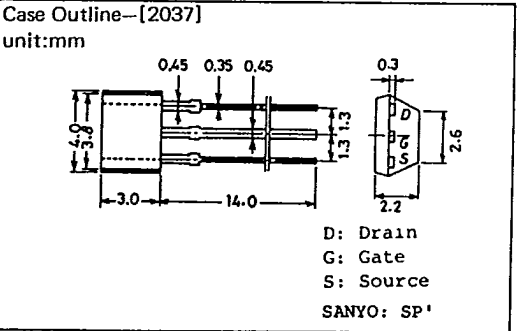
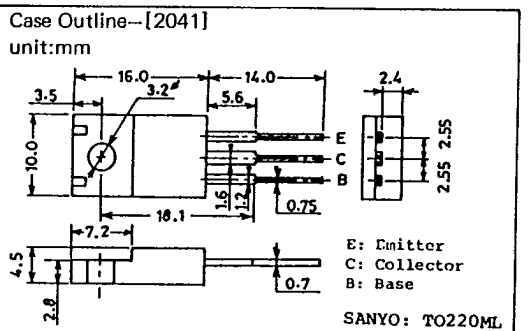
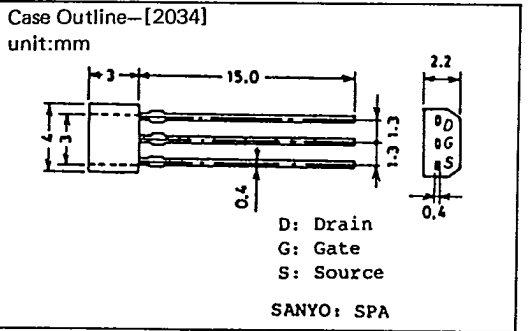
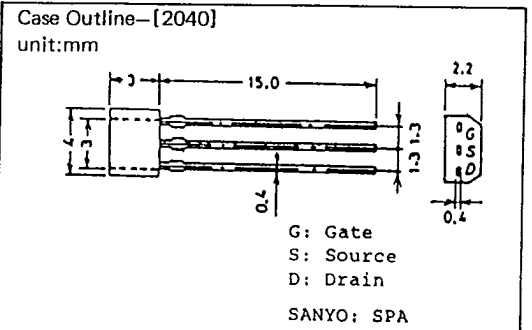
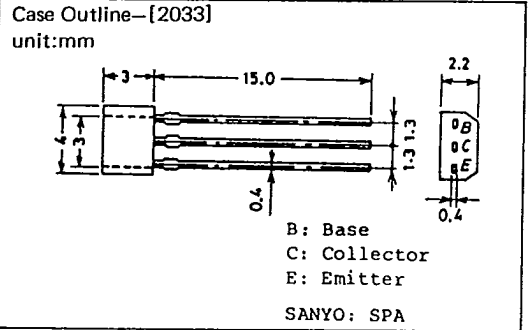
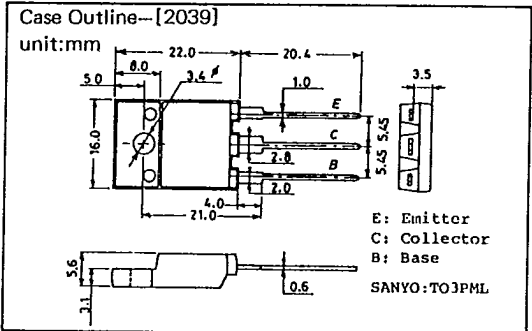
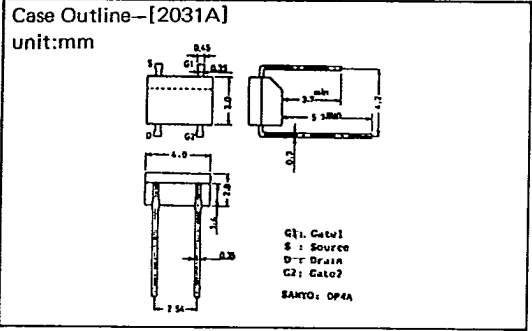
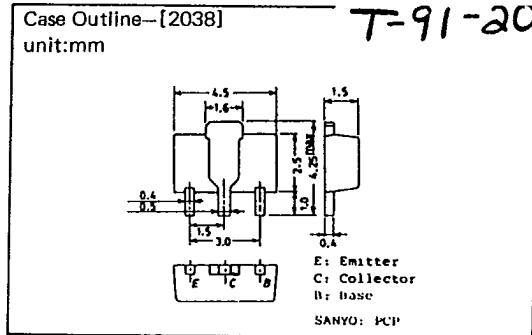
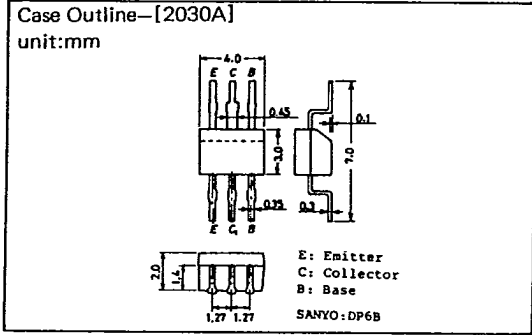

T-91-20

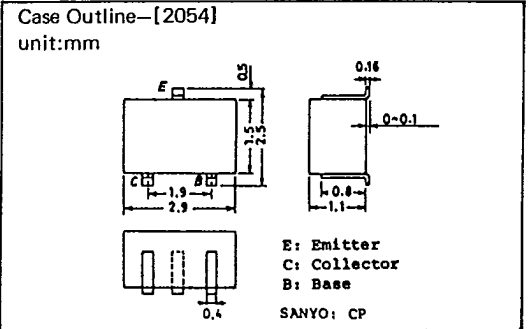
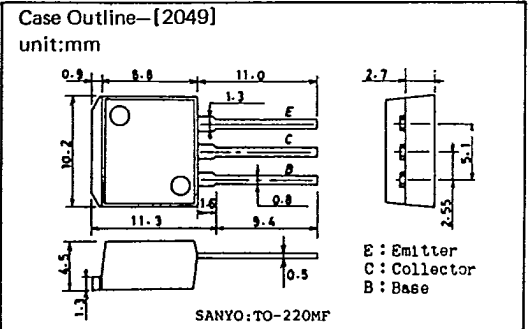
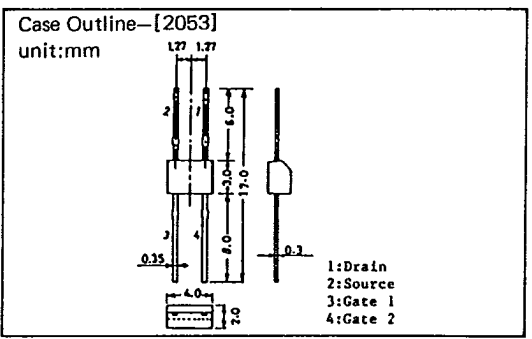
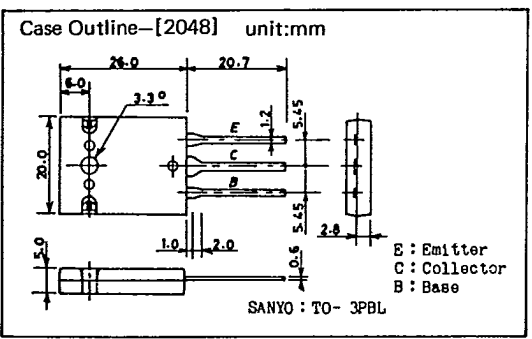
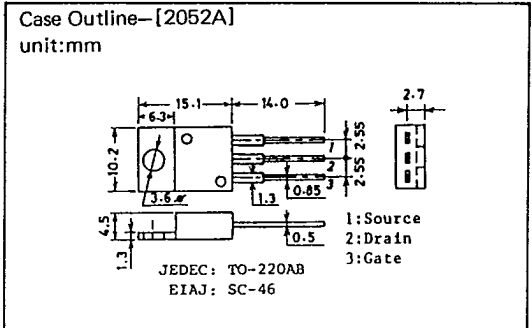
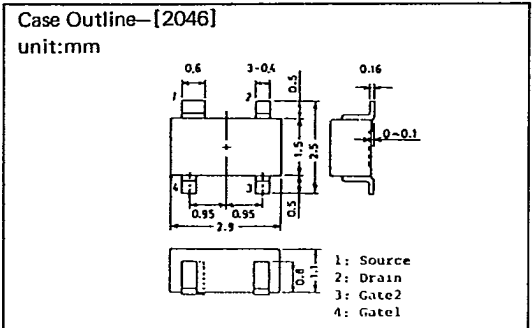
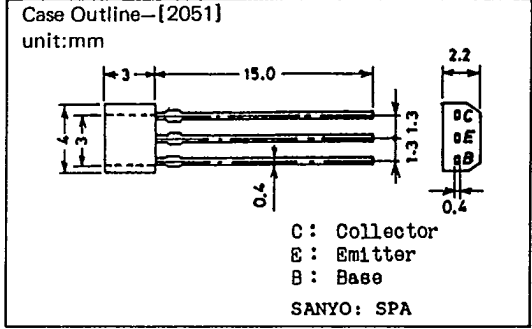
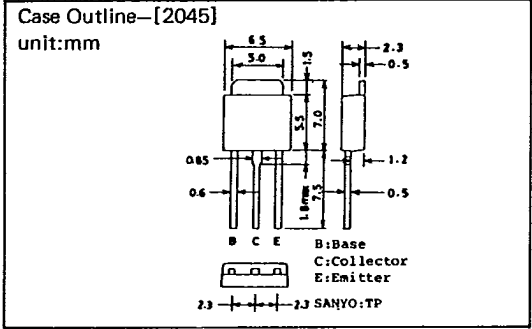
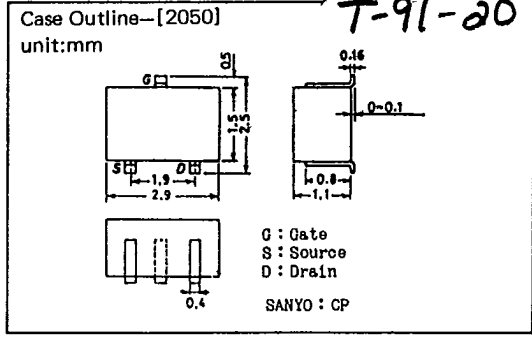
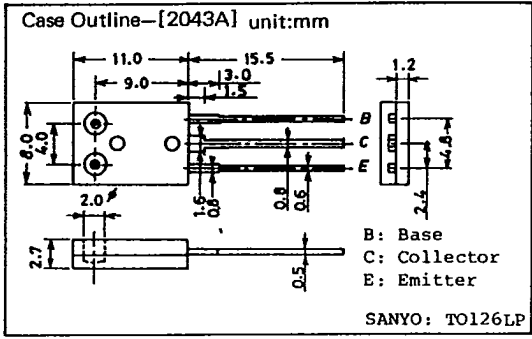

Case Outline-[2056] unit:mm

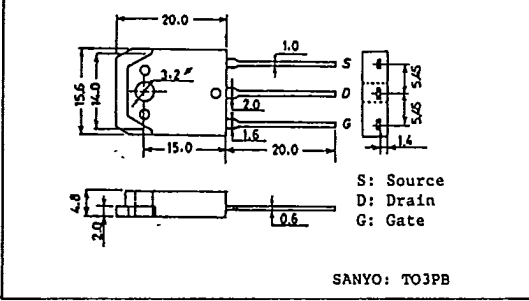

Case Outline-[0008] unit:mm

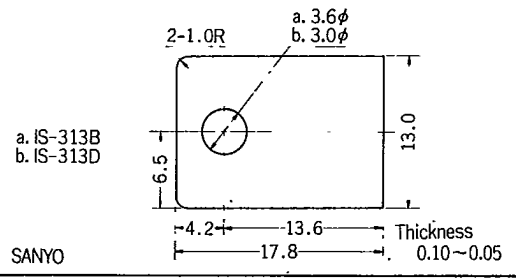

Case Outline-[0004] unit:mm

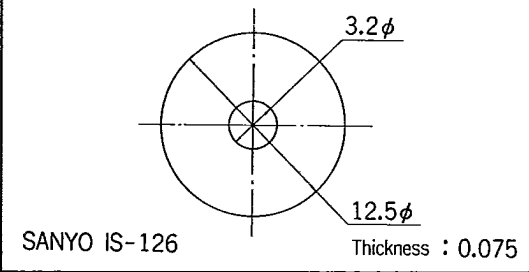

Case Outline-[0009] unit:mm

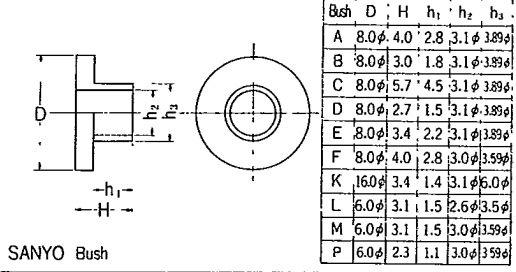

Case Outline-[0005] unit:mm

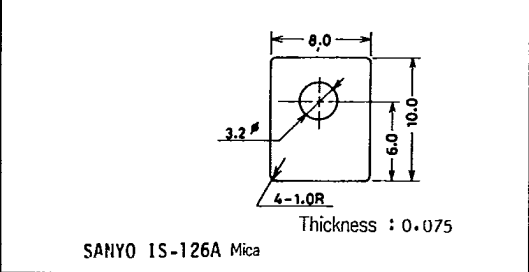

Case Outline-[0010] unit:mm

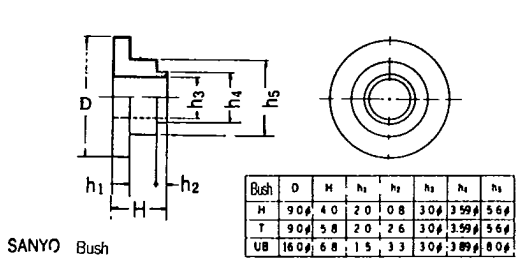

Case Outline-[0006] unit:mm

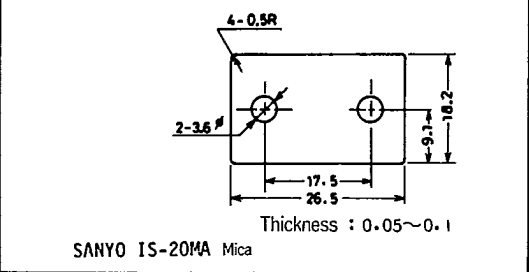

Case Outline-[0011] unit:mm

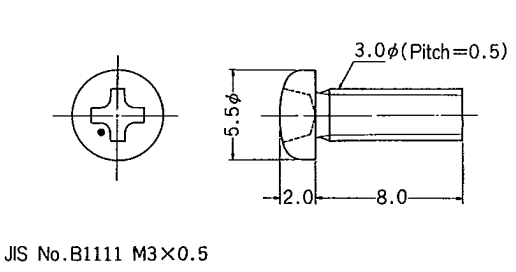

Case Outline-[0007] unit:mm

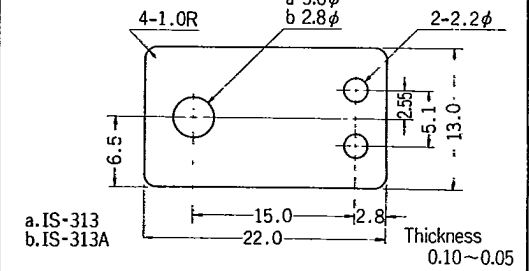

Case Outline-[0012] unit:mm

