

> Features

- High Speed Switching
- Low On-Resistance
- No Secondary Breakdown
- Low Driving Power
- High Voltage
- VGS = ± 30V Guarantee
- Avalanche Proof

> Applications

- Switching Regulators
- UPS
- DC-DC converters
- General Purpose Power Amplifier

> Maximum Ratings and Characteristics

- Absolute Maximum Ratings (TC=25°C), unless otherwise specified

Item	Symbol	Rating	Unit
Drain-Source-Voltage	V _{DS}	500	V
Drain-Gate-Voltage (R _{GS} =20KΩ)	V _{DGR}	500	V
Continous Drain Current	I _D	5	A
Pulsed Drain Current	I _{D(puls)}	20	A
Gate-Source-Voltage	V _{GS}	±30	V
Max. Power Dissipation	P _D	60	W
Operating and Storage Temperature Range	T _{ch}	150	°C
	T _{stg}	-55 ~ +150	°C

- Electrical Characteristics (TC=25°C), unless otherwise specified

Item	Symbol	Test conditions	Min.	Typ.	Max.	Unit
Drain-Source Breakdown-Voltage	V _{(BR)DSS}	I _D =1mA V _{GS} =0V	500			V
Gate Threshold Voltage	V _{GS(th)}	I _D =1mA V _{DS} =V _{GS}	2,5	3,0	3,5	V
Zero Gate Voltage Drain Current	I _{DSS}	V _{DS} =500V T _{ch} =25°C		10	500	μA
		V _{GS} =0V T _{ch} =125°C		0,2	1,0	mA
Gate Source Leakage Current	I _{GSS}	V _{GS} =±30V V _{DS} =0V		10	100	nA
Drain Source On-State Resistance	R _{DS(on)}	I _D =2,5A V _{GS} =10V		1,2	1,6	Ω
Forward Transconductance	g _{fs}	I _D =2,5A V _{DS} =25V	2	4		S
Input Capacitance	C _{iss}	V _{DS} =25V		1000	1500	pF
Output Capacitance	C _{oss}	V _{GS} =0V		85	130	pF
Reverse Transfer Capacitance	C _{rss}	f=1MHz		20	30	pF
Turn-On-Time t _{on} (t _{on} =t _{d(on)} +t _r)	t _{d(on)}	V _{CC} =300V		20	30	ns
		I _D =5A		15	25	ns
Turn-Off-Time t _{off} (t _{off} =t _{d(off)} +t _f)	t _{d(off)}	V _{GS} =10V		45	70	ns
		R _{GS} =10 Ω		20	30	ns
Avalanche Capability	I _{AV}	L = 100μH T _{ch} =25°C	5			A
Continous Reverse Drain Current	I _{DR}				5	A
Pulsed Reverse Drain Current	I _{DRM}				20	A
Diode Forward On-Voltage	V _{SD}	I _F =2xI _{DR} V _{GS} =0V T _{ch} =25°C		1,1	1,65	V
Reverse Recovery Time	t _{rr}	I _F =I _{DR} V _{GS} =0V		400		ns
Reverse Recovery Charge	Q _{rr}	-di _F /dt=100A/μs T _{ch} =25°C		2		μC

- Thermal Characteristics

Item	Symbol	Test conditions	Min.	Typ.	Max.	Unit
Thermal Resistance	R _{th(ch-a)}	channel to air			75	°C/W
	R _{th(ch-c)}	channel to case			2,08	°C/W

> Outline Drawing

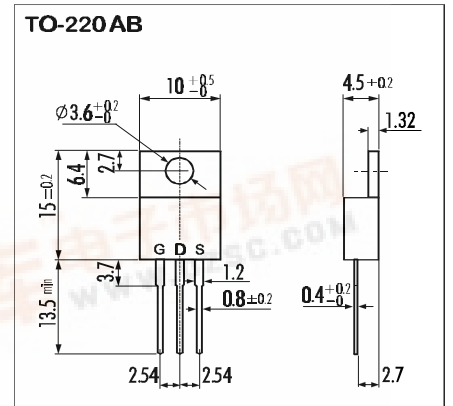

> Equivalent Circuit

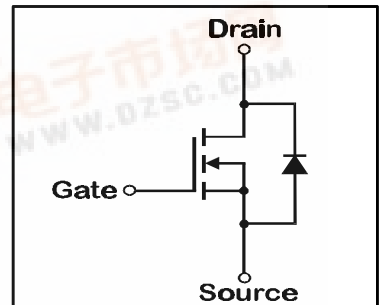

N-channel MOS-FET			
500V	1,6Ω	5A	60W

2SK2021-01

FAP-IIA Series



> Characteristics

Typical Output Characteristics

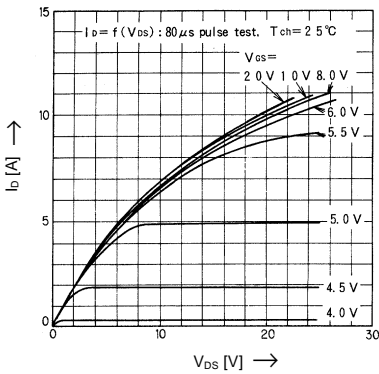

Drain-Source-On-State Resistance vs. T_{ch}

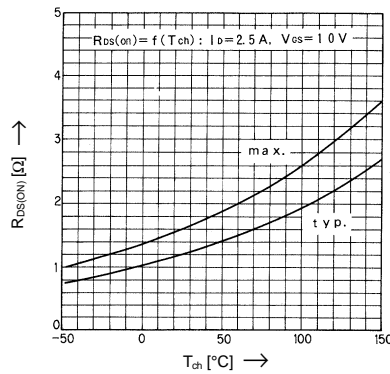

Typical Transfer Characteristics

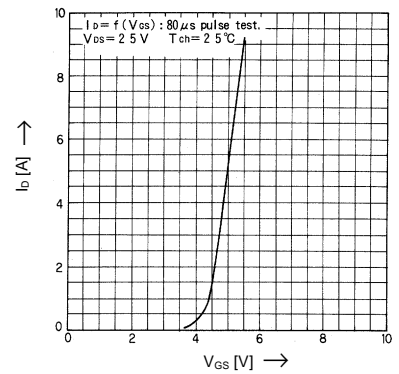

Typical Drain-Source-On-State-Resistance vs. I_D

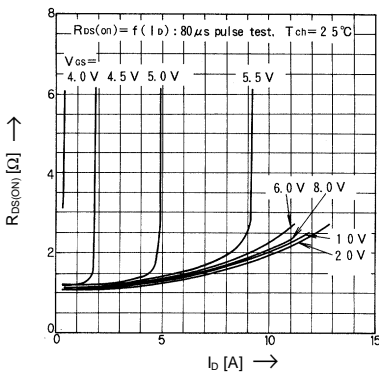

Typical Forward Transconductance vs. I_D

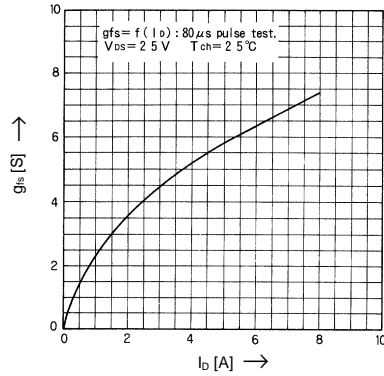

Gate Threshold Voltage vs. T_{ch}

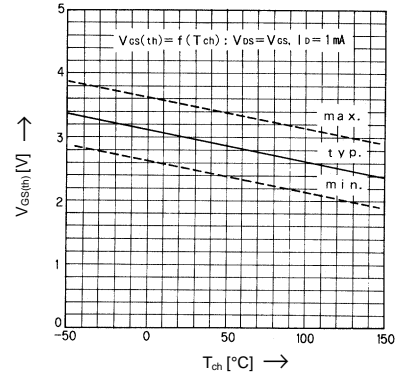

Typical Capacitance vs. V_{DS}

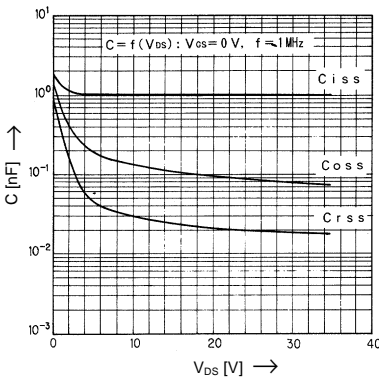

Typical Input Charge

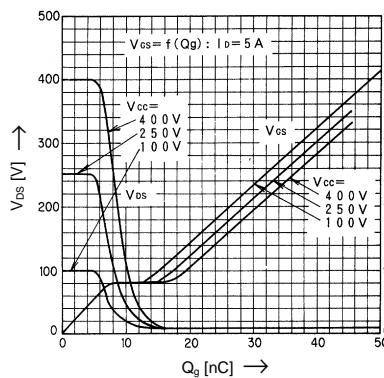

Forward Characteristics of Reverse Diode

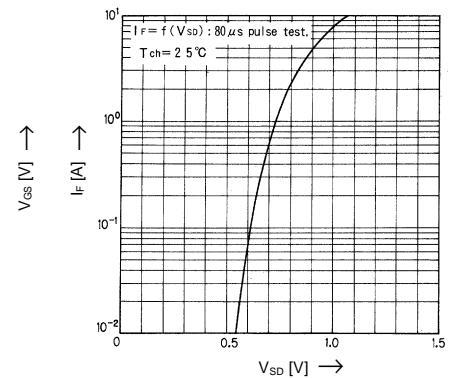

Allowable Power Dissipation vs. T_c

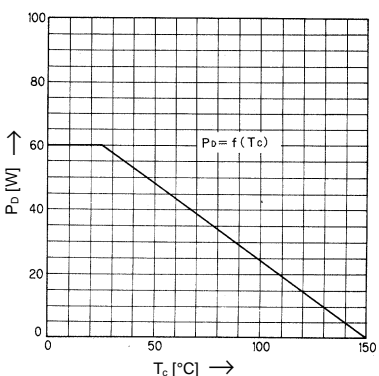

Safe operation area

