

2SK512

HITACHI/(OPTOELECTRONICS) 61E D

SILICON N-CHANNEL MOS FET

HIGH SPEED POWER SWITCHING

FEATURES

- Low On-Resistance. ($R_{on}=0.55\Omega$)
- High Speed Switching.
- High Voltage ($V_{DSS}=500V$)
- No Secondary Breakdown.
- Suitable for Switching Regulator, DC-DC Converter, and Motor Control.

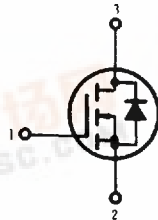

1. Gate
2. Source
3. Drain
(Case)

(Dimensions in mm)

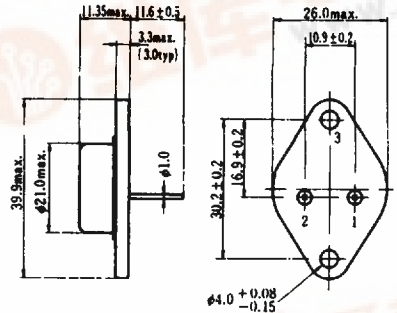

(JEDEC TO-3)

POWER VS. TEMPERATURE DERATING

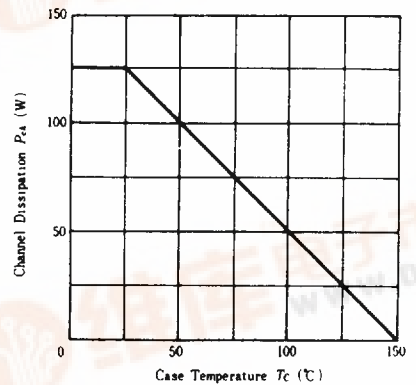

ABSOLUTE MAXIMUM RATINGS ($T_c=25^\circ C$)

Item	Symbol	Rating	Unit
Drain-Source Voltage	V_{DSS}	500	V
Gate-Source Voltage	V_{GSS}	± 20	V
Drain Current	I_D	12	A
Drain Peak Current	$I_{D(peak)}$	20	A
Body-Drain Diode Reverse Drain Current	I_{DR}	12	A
Channel Dissipation	P_{ch}^*	125	W
Channel Temperature	T_{ch}	150	°C
Storage Temperature	T_{stg}	-55 ~ +150	°C

*Value at $T_c=25^\circ C$

ELECTRICAL CHARACTERISTICS ($T_c=25^\circ C$)

Item	Symbol	Test Condition	min.	typ.	max.	Unit
Drain-Source Breakdown Voltage	$V_{(BR)DSS}$	$I_D=10mA, V_{GS}=0$	500	—	—	V
Gate-Source Leak Current	I_{GSS}	$V_{GS}=\pm 20V, V_{DS}=0$	—	—	± 1	μA
Zero Gate Voltage Drain Current	I_{DSS}	$V_{DS}=400V, V_{GS}=0$	—	—	1	mA
Gate-Source Cutoff Voltage	$V_{GS(off)}$	$I_D=1mA, V_{DS}=10V$	2.0	—	4.0	V
Static Drain-Source On State Resistance	$R_{DS(on)}$	$I_D=6A, V_{GS}=15V^*$	—	0.55	0.65	Ω
Drain-Source Saturation Voltage	$V_{DS(on)}$	$I_D=6A, V_{GS}=15V^*$	—	3.3	3.9	V
Forward Transfer Admittance	$ y_{fs} $	$I_D=6A, V_{DS}=10V^*$	2.5	3.5	—	S
Input Capacitance	C_{iss}	$V_{DS}=10V, V_{GS}=0, f=1MHz$	—	1800	—	pF
Output Capacitance	C_{oss}		—	400	—	pF
Reverse Transfer Capacitance	C_{rss}		—	50	—	pF
Turn-on Delay Time	t_{don}	$I_D=2A, V_{GS}=15V, R_L=15\Omega$	—	20	—	ns
Rise Time	t_r		—	45	—	ns
Turn-off Delay Time	t_{doff}		—	230	—	ns
Fall Time	t_f		—	70	—	ns
Body-Drain Diode Forward Voltage	V_{DF}	$I_F=6A, V_{GS}=0$	—	1.0	—	V
Body-Drain Diode Reverse Recovery Time	t_r	$I_F=6A, V_{GS}=0$ $di_F/dt=100A/\mu s$	—	400	—	ns

*Pulse Test



MAXIMUM SAFE OPERATION AREA

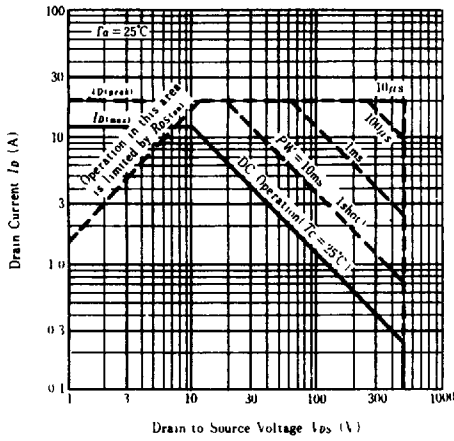

TYPICAL OUTPUT CHARACTERISTICS

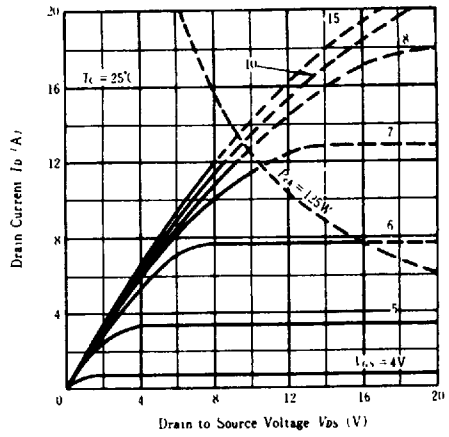

TYPICAL TRANSFER CHARACTERISTICS

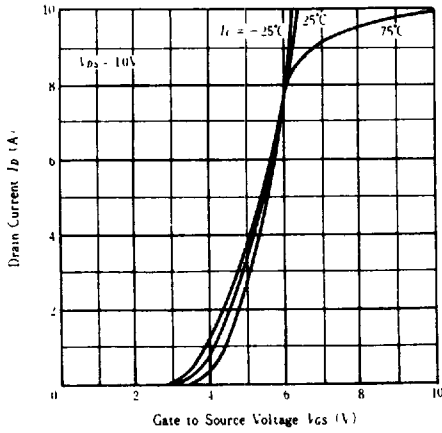

DRAIN-SOURCE SATURATION VOLTAGE VS. GATE-SOURCE VOLTAGE

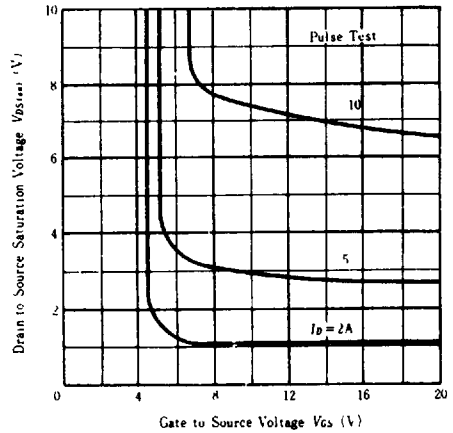

FORWARD TRANSFER ADMITTANCE VS. DRAIN CURRENT

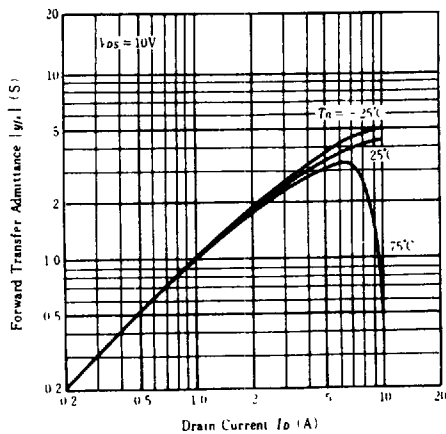

STATIC DRAIN-SOURCE ON STATE RESISTANCE VS. TEMPERATURE

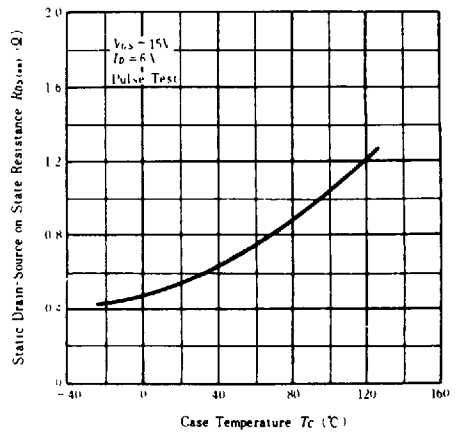

TYPICAL CAPACITANCE VS. DRAIN-SOURCE VOLTAGE

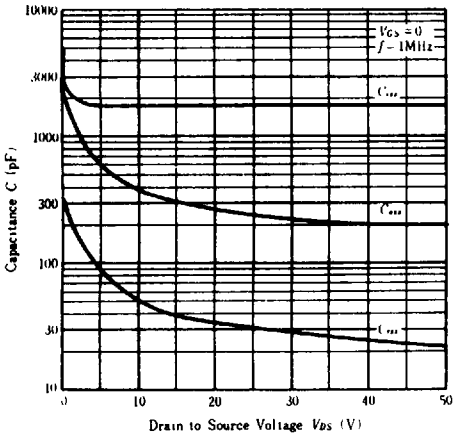

FORWARD TRANSFER ADMITTANCE VS. FREQUENCY

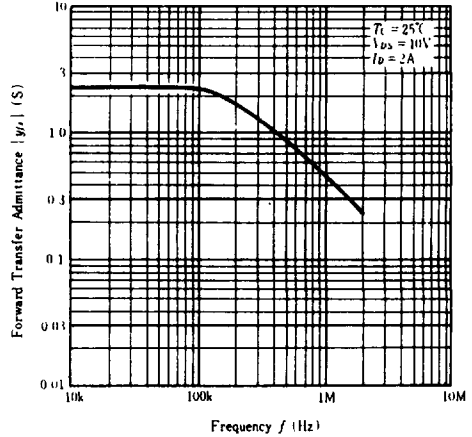

SWITCHING CHARACTERISTICS

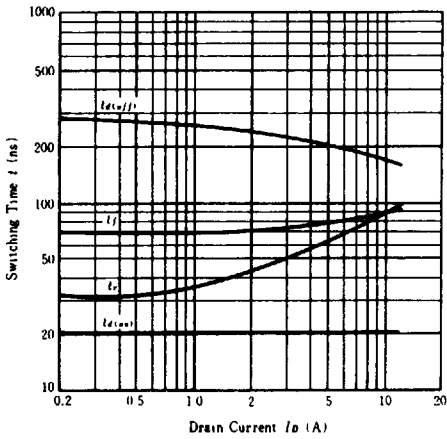

MAXIMUM BODY-DRAIN DIODE FORWARD VOLTAGE

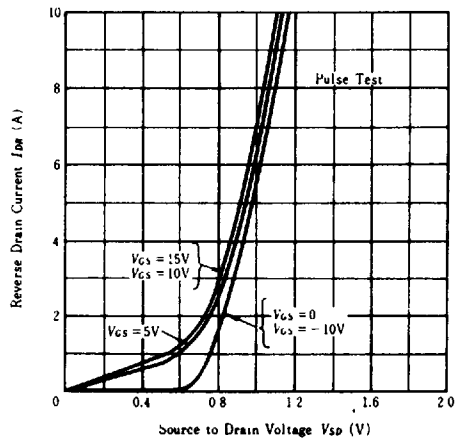

DYNAMIC INPUT CHARACTERISTICS

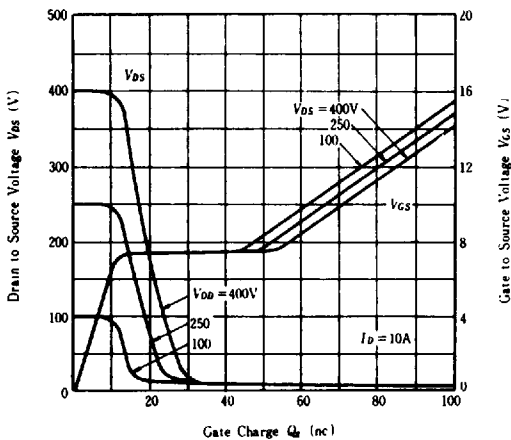

SWITCHING TIME TEST CIRCUIT

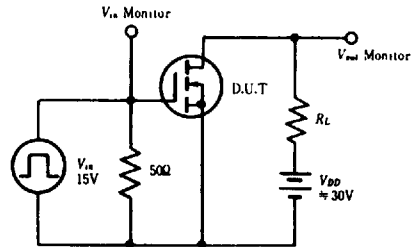

WAVEFORMS

