



TM00407

MODEM MAGNETICS
PCMCIA V.34 Modem Transformers

- Designed to match a 600Ω line to a 301Ω load while providing isolation and balance in PCMCIA Type II V.34 modem applications
- Qualified per Bellcore TR-TSY-000357-1
- Approved by UL and CSA
- Each transformer, while being identical electrically, has a distinctive terminal configuration to accommodate different PWB offsets in the PC card
- Minimum interwinding breakdown voltage of 1000 Vrms

ELECTRICAL SPECIFICATIONS at 25° C

Part Number	Turns Ratio ± 2%	Insertion Loss dB	Return Loss dB	Frequency Response dB	DCR Ω max		Harmonic Distortion dB	Longitudinal Balance dB
		@ 1 kHz	300 Hz - 3500 Hz	200 Hz - 5 kHz	Pri	Sec	-10 dBm, 600 Hz	300 Hz - 3500 Hz
2796A 2796A2 2796A3 2796A4 2796A5	1 : 1	≤ 2.7	≥ 30	≤ 0.1	165	165	≥ 80	≥ 60

SCHEMATIC

2796A
2796A2
2796A3
2796A4
2796A5

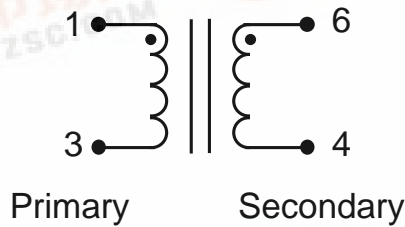

TYPICAL SPICE TRANSMISSION MODEL

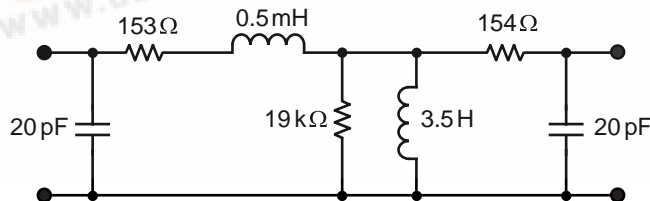



MODEM MAGNETICS

PCMCIA V.34 Modem Transformers

TM00407

MECHANICAL

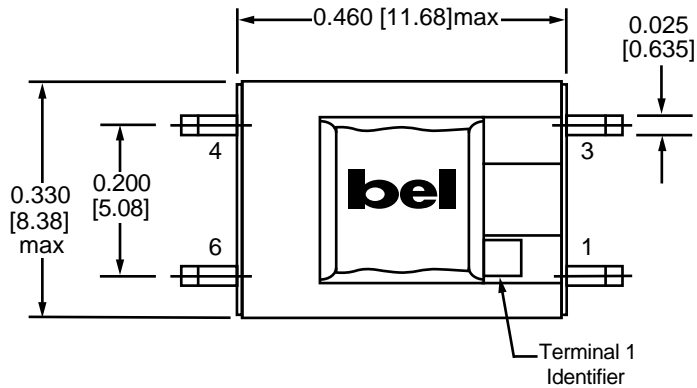

2796A
2796A2
2796A3
2796A4
2796A5

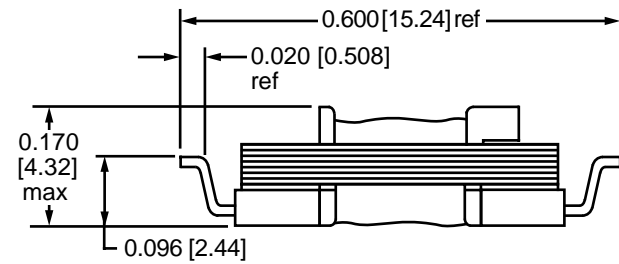

Note: Unless otherwise specified, dimensions are nominal and in inches [millimeters].

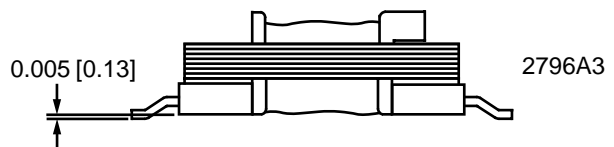
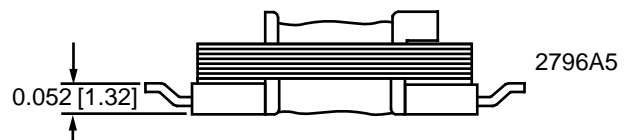
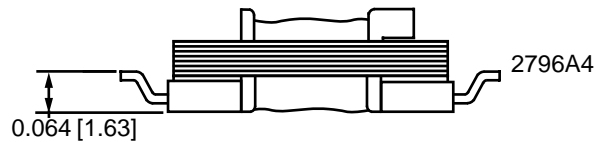
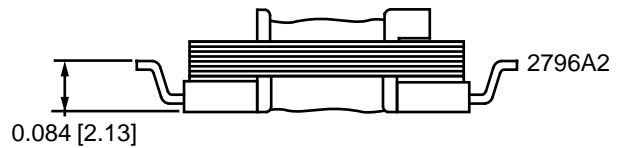
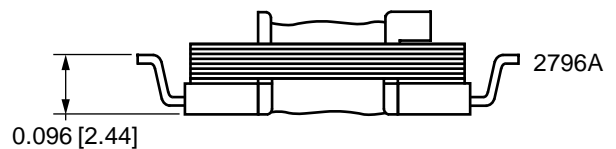

©2000 Bel Fuse Inc. Specifications subject to change without notice. 05.00

CORPORATE

Bel Fuse Inc.
198 Van Vorst Street
Jersey City, NJ 07302
Tel 201-432-0463
Fax 201-432-9542
www.belfuse.com

FAR EAST

Bel Fuse Ltd.
8F / 8 Luk Hop Street
San Po Kong
Kowloon, Hong Kong
Tel 852-2328-5515
Fax 852-2352-3706
www.belfuse.com

EUROPE

Bel Fuse Europe Ltd.
Preston Technology Management Centre
Marsh Lane, Suite G7, Preston
Lancashire, PR1 8UD, U.K.
Tel 44-1772-556601
Fax 44-1772-888366
www.belfuse.com