

Bulletin PD-20842 rev. B 05/06

International IOR Rectifier

20CTQ...PbF Series

SCHOTTKY RECTIFIER

20 Amp

$I_{F(AV)} = 20\text{Amp}$
 $V_R = 35/45\text{V}$

Major Ratings and Characteristics

Characteristics	Values	Units
$I_{F(AV)}$ Rectangular waveform	20	A
V_{RRM} range	35/45	V
I_{FSM} @ tp = 5 μs sine	1060	A
V_F @ 10 Apk, $T_J = 125^\circ\text{C}$ (per leg)	0.57	V
T_J range	-55 to 175	$^\circ\text{C}$

Description/ Features

The 20CTQ...PbF center tap Schottky rectifier series has been optimized for low reverse leakage at high temperature. The proprietary barrier technology allows for reliable operation up to 175 $^\circ\text{C}$ junction temperature. Typical applications are in switching power supplies, converters, free-wheeling diodes, and reverse battery protection.

- 175 $^\circ\text{C}$ T_J operation
- Center tap TO-220 package
- Low forward voltage drop
- High purity, high temperature epoxy encapsulation for enhanced mechanical strength and moisture resistance
- High frequency operation
- Guard ring for enhanced ruggedness and long term reliability
- Lead-Free ("PbF" suffix)

Case Styles

20CTQ...PbF

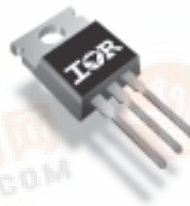

TO-220

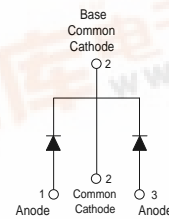

Voltage Ratings

Part number	20CTQ035PbF	20CTQ040PbF	20CTQ045PbF
V_R Max. DC Reverse Voltage (V)	35	40	45
V_{RWM} Max. Working Peak Reverse Voltage (V)			

Absolute Maximum Ratings

Parameters	20CTQ	Units	Conditions
$I_{F(AV)}$ Max. Average Forward Current * See Fig. 5	20	A	50% duty cycle @ $T_C = 145^\circ\text{C}$, rectangular wave form
I_{FSM} Max. Peak One Cycle Non-Repetitive Surge Current (Per Leg) * See Fig. 7	1060	A	Following any rated load condition and with rated V_{RRM} applied
	265		
E_{AS} Non-Repetitive Avalanche Energy (Per Leg)	13	mJ	$T_J = 25^\circ\text{C}$, $I_{AS} = 2.0$ Amps, $L = 6.5$ mH
I_{AR} Repetitive Avalanche Current (Per Leg)	2.0	A	Current decaying linearly to zero in 1 μsec Frequency limited by T_J max. $V_A = 1.5 \times V_R$ typical

Electrical Specifications

Parameters	20CTQ	Units	Conditions
V_{FM} Max. Forward Voltage Drop (Per Leg) * See Fig. 1 (1)	0.64	V	@ 10A $T_J = 25^\circ\text{C}$
	0.76	V	@ 20A
	0.57	V	@ 10A $T_J = 125^\circ\text{C}$
	0.68	V	@ 20A
I_{RM} Max. Reverse Leakage Current (Per Leg) * See Fig. 2 (1)	2	mA	$T_J = 25^\circ\text{C}$ $V_R = \text{rated } V_R$
	15	mA	$T_J = 125^\circ\text{C}$
C_T Max. Junction Capacitance (Per Leg)	900	pF	$V_R = 5V_{DC}$ (test signal range 100Khz to 1Mhz) 25°C
L_S Typical Series Inductance (Per Leg)	8.0	nH	Measured lead to lead 5mm from package body
dv/dt Max. Voltage Rate of Change (Rated V_R)	10000	V/ μs	

(1) Pulse Width < 300 μs , Duty Cycle <2%

Thermal-Mechanical Specifications

Parameters	20CTQ	Units	Conditions
T_J Max. Junction Temperature Range	-55 to 175	$^\circ\text{C}$	
T_{stg} Max. Storage Temperature Range	-55 to 175	$^\circ\text{C}$	
R_{thJC} Max. Thermal Resistance Junction to Case (Per Leg)	3.25	$^\circ\text{C/W}$	DC operation * See Fig. 4
R_{thJC} Max. Thermal Resistance Junction to Case (Per Package)	1.63	$^\circ\text{C/W}$	DC operation
R_{thCS} Typical Thermal Resistance, Case to Heatsink	0.50	$^\circ\text{C/W}$	Mounting surface, smooth and greased
wt Approximate Weight	2 (0.07)	g (oz.)	
T Mounting Torque	Min. 6 (5)	Kg-cm (lbf-in)	
	Max. 12 (10)		
Marking Device	20CTQ045		

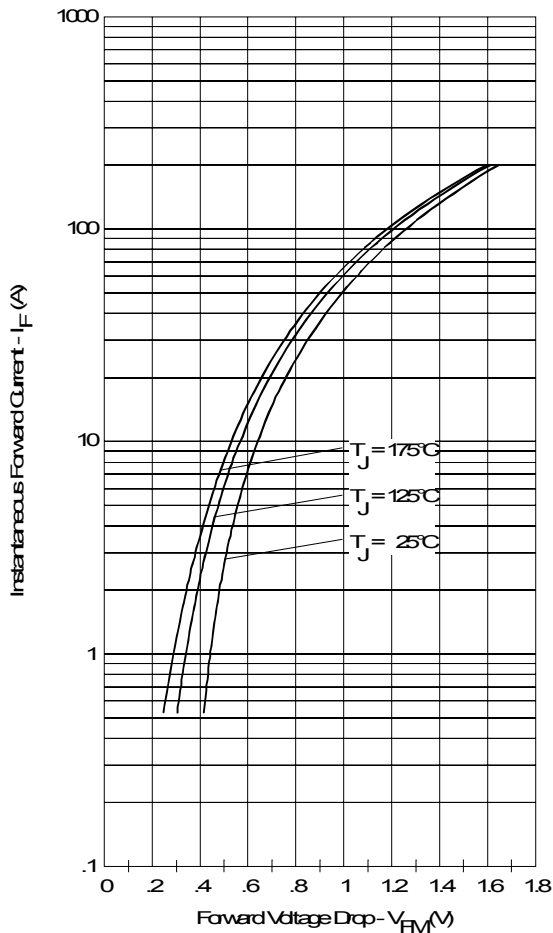

Fig. 1 - Max. Forward Voltage Drop Characteristics (Per Leg)

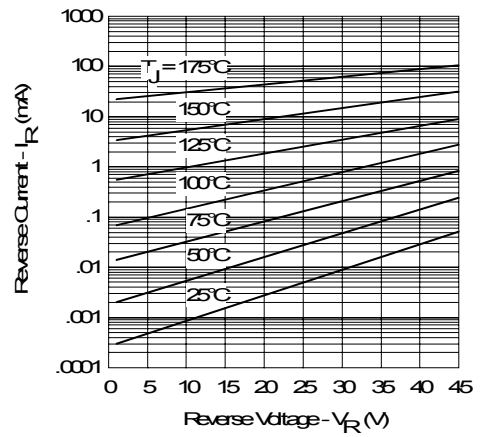

Fig. 2 - Typical Values Of Reverse Current Vs. Reverse Voltage (Per Leg)

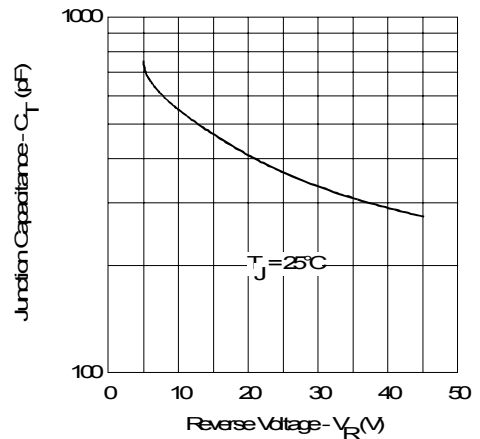

Fig. 3 - Typical Junction Capacitance Vs. Reverse Voltage (Per Leg)

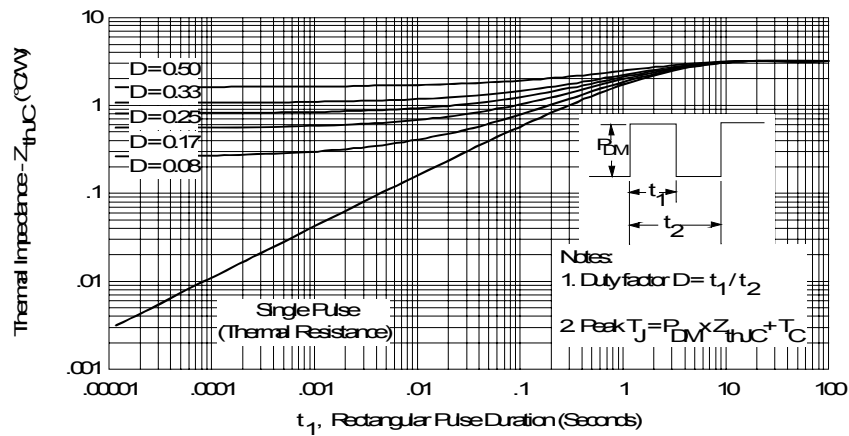

Fig. 4 - Max. Thermal Impedance Z_{thJC} Characteristics (Per Leg)

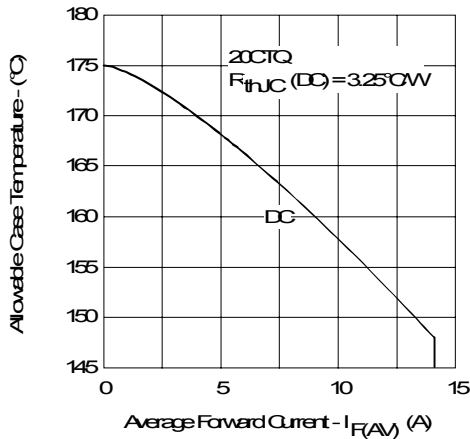

Fig. 5 - Max. Allowable Case Temperature Vs. Average Forward Current (Per Leg)

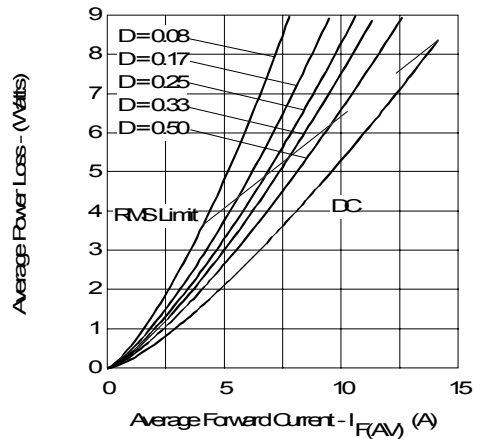

Fig. 6 - Forward Power Loss Characteristics (Per Leg)

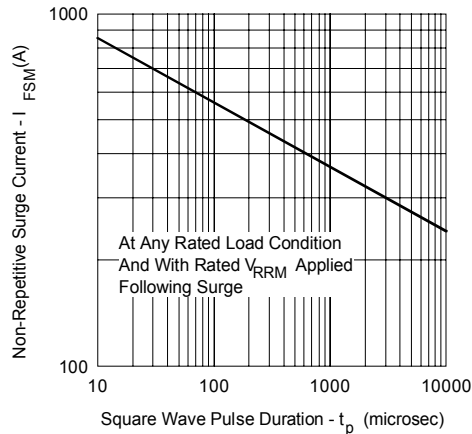

Fig. 7 - Max. Non-Repetitive Surge Current (Per Leg)

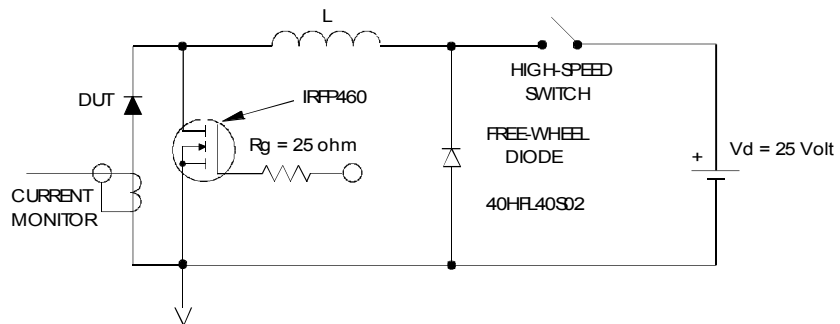
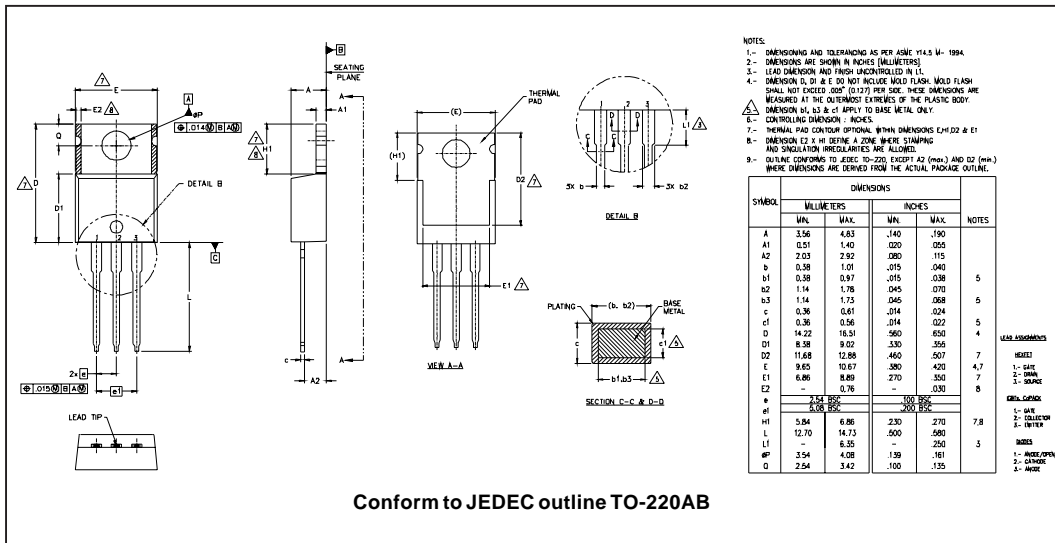
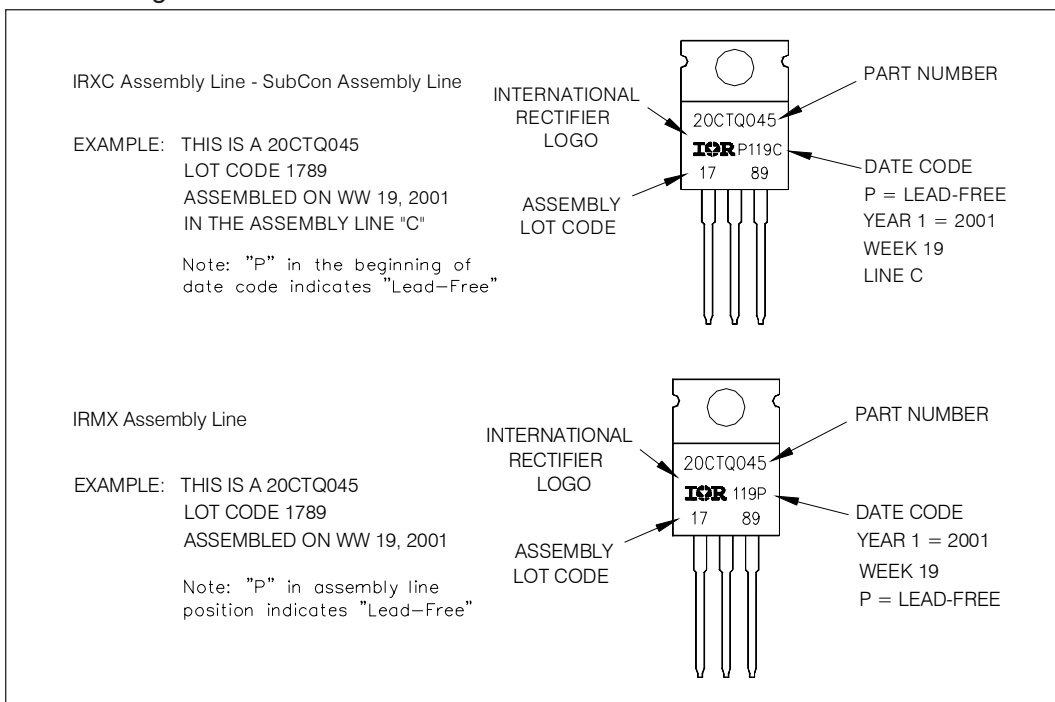

Fig. 8 - Unclamped Inductive Test Circuit

Outline Table



Part Marking Information



Ordering Information Table

Device Code					
20	C	T	Q	045	PbF
①	②	③	④	⑤	⑥
1	- Current Rating (20 = 20A)				
2	- Circuit Configuration C = Common Cathode				
3	- Package T = TO-220				
4	- Schottky "Q" Series				
5	- Voltage Ratings				
6	- • none = Standard Production • PbF = Lead-Free				
				035 = 35V 040 = 40V 045 = 45V	
Tube Standard Pack Quantity : 50 pieces					

Data and specifications subject to change without notice.
This product has been designed and qualified for Industrial Level and Lead-Free.
Qualification Standards can be found on IR's Web site.