



DATA SHEET

3KP5.0~3KP220CA

GLASS PASSIVATED JUNCTION TRANSIENT VOLTAGE SUPPRESSOR

3000 Watt Peak Power VOLTAGE - 5.0 to 220 Volts

FEATURES

- Plastic package has Underwriters Laboratory Flammability Classification 94V-0
- Glass passivated chip junction in P-600 package
- 3000W Peak Pulse Power capability at on 10/1000µs waveform
- Excellent clamping capability
- Low zener impedance
- Repetition rate(Duty Cycle):.05%
- Fast response time: typically less than 1.0 ps from 0 volts to BV min
- Typical IR less than 1µA above 10V
- High temperature soldering guaranteed: 260°C/10 seconds/.375" (9.5mm) lead length/5lbs., (2.3kg) tension

MECHANICAL DATA

Case: JEDEC P600 molded plastic
 Terminals: Axial leads, solderable per MIL-STD-750, Method 2026
 Polarity: Color band denoted cathode except Bipolar
 Mounting Position: Any
 Weight: 0.07 ounce, 2.1 gram

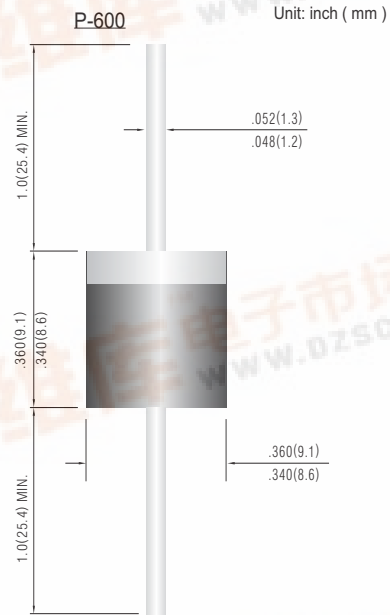

DEVICES FOR BIPOLAR APPLICATIONS

For Bidirectional use C or CA Suffix for types 3KP5.0 thru types 3KP220
 Electrical characteristics apply in both directions.

MAXIMUM RATINGS AND CHARACTERISTICS

Rating at 25°C ambient temperature unless otherwise specified. Resistive or inductive load, 60Hz.
 For Capacitive load derate current by 20%.

RATING	SYMBOL	VALUE	UNITS
Peak Power Dissipation at $T_A=25^\circ\text{C}$, $T_P=1\text{ms}$ (Note 1)	P_{PK}	Minimum Max 3000	Watts
Steady State Power Dissipation at $T_L=75^\circ\text{C}$ Lead Lengths .375",(9.5mm) (Note 2)	PD	8.0	Watts
Peak Forward Surge Current, 8.3ms Single Half Sine-Wave Superimposed on Rated Load(JECED Method) (Note 3)	I_{FSM}	250	Amps
Operating and Storage Temperature Range	T_J, T_{STG}	-55 to +175	$^\circ\text{C}$

NOTES:

- 1.Non-repetitive current pulse, per Fig. 3 and derated above $T_A=25^\circ\text{C}$ per Fig. 2.
2. Mounted on Copper Leaf area of $0.79\text{in}^2(20\text{mm}^2)$.
3. 8.3ms single half sine-wave, duty cycle= 4 pulses per minutes maximum.





Part Number	V _{RWM}	V _{BR} @ I _T			I _R @ V _{RWM}		V _C @ I _{PP}		PACKAGE
		Min.	Max.	I _T	UNI-	BI-	V	A	
	V	V	V	mA	uA	uA			
3000W Transient Voltage Suppressor									
3KP5.0(C)	5.0	6.40	7.55	10	1000	2000	9.6	312.5	P-600
3KP5.0(C)A	5.0	6.40	7.25	10	1000	2000	9.2	326.0	P-600
3KP6.0(C)	6.0	6.67	8.45	10	1000	2000	11.4	263.2	P-600
3KP6.0(C)A	6.0	6.67	7.67	10	1000	2000	10.3	291.3	P-600
3KP6.5(C)	6.5	7.22	9.14	10	500	1000	12.3	243.9	P-600
3KP6.5(C)A	6.5	7.22	8.30	10	500	1000	11.2	267.9	P-600
3KP7.0(C)	7.0	7.78	9.86	10	200	400	13.3	225.6	P-600
3KP7.0(C)A	7.0	7.78	8.95	10	200	400	12.0	250.0	P-600
3KP7.5(C)	7.5	8.33	10.67	1.0	100	200	14.3	209.8	P-600
3KP7.5(C)A	7.5	8.33	9.58	1.0	100	200	12.9	232.6	P-600
3KP8.0(C)	8.0	8.89	11.30	1.0	50	100	15.0	220.0	P-600
3KP8.0(C)A	8.0	8.89	10.23	1.0	50	100	13.6	220.6	P-600
3KP8.5(C)	8.5	9.44	11.92	1.0	25	50	15.9	188.8	P-600
3KP8.5(C)A	8.5	9.44	10.82	1.0	25	50	14.4	208.4	P-600
3KP9.0(C)	9.0	10.0	12.6	1.0	10	20	16.9	177.4	P-600
3KP9.0(C)A	9.0	10.0	11.5	1.0	10	20	15.4	194.8	P-600
3KP10(C)	10	11.1	14.1	1.0	5	5	18.8	159.6	P-600
3KP10(C)A	10	11.1	12.8	1.0	5	5	17.0	176.4	P-600
3KP11(C)	11	12.2	15.4	1.0	5	5	20.1	149.2	P-600
3KP11(C)A	11	12.2	14.0	1.0	5	5	18.2	184.8	P-600
3KP12(C)	12	13.3	16.9	1.0	5	5	22.0	136.4	P-600
3KP12(C)A	12	13.3	15.3	1.0	5	5	19.9	150.6	P-600
3KP13(C)	13	14.4	18.2	1.0	5	5	23.8	126.0	P-600
3KP13(C)A	13	14.4	16.5	1.0	5	5	21.5	139.4	P-600
3KP14(C)	14	15.6	19.8	1.0	5	5	25.8	116.2	P-600
3KP14(C)A	14	15.6	17.9	1.0	5	5	23.2	129.4	P-600
3KP15(C)	15	16.7	21.1	1.0	5	5	26.9	111.6	P-600
3KP15(C)A	15	16.7	19.2	1.0	5	5	24.4	123.0	P-600
3KP16(C)	16	17.8	22.6	1.0	5	5	28.8	104.2	P-600
3KP16(C)A	16	17.8	20.5	1.0	5	5	26.0	115.4	P-600
3KP17(C)	17	18.9	23.9	1.0	5	5	30.5	98.4	P-600
3KP17(C)A	17	18.9	21.7	1.0	5	5	27.6	106.6	P-600
3KP18(C)	18	20.0	25.3	1.0	5	5	32.2	93.2	P-600
3KP18(C)A	18	20.0	23.3	1.0	5	5	29.2	102.8	P-600
3KP20(C)	20	22.2	28.1	1.0	5	5	35.8	83.8	P-600
3KP20(C)A	20	22.2	25.5	1.0	5	5	32.4	92.6	P-600
3KP22(C)	22	24.4	30.9	1.0	5	5	39.4	76.2	P-600
3KP22(C)A	22	24.4	28.0	1.0	5	5	35.5	84.4	P-600
3KP24(C)	24	26.7	33.8	1.0	5	5	43.0	69.8	P-600
3KP24(C)A	24	26.7	30.7	1.0	5	5	38.9	77.2	P-600
3KP26(C)	26	28.9	36.6	1.0	5	5	46.6	64.4	P-600
3KP26(C)A	26	28.9	33.2	1.0	5	5	42.1	71.2	P-600
3KP28(C)	28	31.1	39.4	1.0	5	5	50.0	60.0	P-600
3KP28(C)A	28	31.1	35.8	1.0	5	5	45.4	66.0	P-600
3KP30(C)	30	33.3	42.2	1.0	5	5	53.5	56.0	P-600
3KP30(C)A	30	33.3	38.3	1.0	5	5	48.4	62.0	P-600
3KP33(C)	33	36.7	46.5	1.0	5	5	59.0	50.4	P-600
3KP33(C)A	33	36.7	42.2	1.0	5	5	53.3	56.2	P-600
3KP36(C)	36	40.0	50.7	1.0	5	5	64.3	46.6	P-600
3KP36(C)A	36	40.0	46.0	1.0	5	5	58.1	51.6	P-600
3KP40(C)	40	44.4	56.3	1.0	5	5	71.4	42.0	P-600
3KP40(C)A	40	44.4	51.1	1.0	5	5	64.5	46.4	P-600



Part Number	V _{RWM}	V _{BR} @ I _T			I _r @ V _{RWM}		V _c @ I _{PP}		PACKAGE
		Min.	Max.	I _T	UNI-	BI-			
	V	V	V	mA	uA	uA	V	A	
3000W Transient Voltage Suppressor									
3KP43(C)	43	47.8	60.5	1.0	5	5	76.7	39.2	P-600
3KP43(C)A	43	47.8	54.9	1.0	5	5	69.4	43.2	P-600
3KP45(C)	45	50.0	63.3	1.0	5	5	80.3	37.4	P-600
3KP45(C)A	45	50.0	57.5	1.0	5	5	72.7	41.2	P-600
3KP48(C)	48	53.3	67.5	1.0	5	5	85.5	35.0	P-600
3KP48(C)A	48	53.3	61.3	1.0	5	5	77.4	38.8	P-600
3KP51(C)	51	56.7	71.8	1.0	5	5	91.1	37.0	P-600
3KP51(C)A	51	56.7	65.2	1.0	5	5	82.4	36.4	P-600
3KP54(C)	54	60.0	76.0	1.0	5	5	96.3	31.2	P-600
3KP54(C)A	54	60.0	69.0	1.0	5	5	87.1	34.4	P-600
3KP58(C)	58	64.4	81.6	1.0	5	5	103	29.2	P-600
3KP58(C)A	58	64.4	74.1	1.0	5	5	93.6	32.0	P-600
3KP60(C)	60	66.7	84.5	1.0	5	5	107	28.0	P-600
3KP60(C)A	60	66.7	76.7	1.0	5	5	96.8	31.0	P-600
3KP64(C)	64	71.1	90.1	1.0	5	5	114	26.4	P-600
3KP64(C)A	64	71.1	81.8	1.0	5	5	103	29.2	P-600
3KP70(C)	70	77.8	98.6	1.0	5	5	125	24.0	P-600
3KP70(C)A	70	77.8	89.5	1.0	5	5	113	26.6	P-600
3KP75(C)	75	83.3	105.7	1.0	5	5	134	22.4	P-600
3KP75(C)A	75	83.3	95.8	1.0	5	5	121	24.8	P-600
3KP78(C)	78	86.7	109.8	1.0	5	5	139	21.6	P-600
3KP78(C)A	78	86.7	99.7	1.0	5	5	126	22.8	P-600
3KP85(C)	85	94.4	119.2	1.0	5	5	151	19.8	P-600
3KP85(C)A	85	94.4	108.2	1.0	5	5	137	20.8	P-600
3KP90(C)	90	100	126.5	1.0	5	5	160	18.8	P-600
3KP90(C)A	90	100	115.5	1.0	5	5	146	20.6	P-600
3KP100(C)	100	111	141.0	1.0	5	5	179	16.6	P-600
3KP100(C)A	100	111	128.0	1.0	5	5	162	18.6	P-600
3KP110(C)	110	122	154.5	1.0	5	5	196	15.4	P-600
3KP110(C)A	110	122	140.5	1.0	5	5	177	16.8	P-600
3KP120(C)	120	133	169.0	1.0	5	5	214	14.0	P-600
3KP120(C)A	120	133	153.0	1.0	5	5	193	15.6	P-600
3KP130(C)	130	144	182.5	1.0	5	5	231	13.0	P-600
3KP130(C)A	130	144	165.5	1.0	5	5	209	14.4	P-600
3KP150(C)	150	167	211.5	1.0	5	5	268	11.2	P-600
3KP150(C)A	150	167	192.5	1.0	5	5	243	12.4	P-600
3KP160(C)	160	178	226.0	1.0	5	5	287	10.4	P-600
3KP160(C)A	160	178	205.0	1.0	5	5	259	11.6	P-600
3KP170(C)	170	189	239.5	1.0	5	5	304	9.8	P-600
3KP170(C)A	170	189	217.5	1.0	5	5	275	11.0	P-600
3KP180(C)	180	198	253.8	1.0	5	5	322	9.3	P-600
3KP180(C)A	180	198	230.4	1.0	5	5	292	10.3	P-600
3KP190(C)	190	209	267.9	1.0	5	5	340	8.8	P-600
3KP190(C)A	190	209	243.2	1.0	5	5	308	9.7	P-600
3KP200(C)	200	220	282.0	1.0	5	5	358	8.4	P-600
3KP200(C)A	200	220	256.0	1.0	5	5	324	9.3	P-600
3KP210(C)	210	231	296.1	1.0	5	5	376	7.8	P-600
3KP210(C)A	210	231	268.8	1.0	5	5	340	8.8	P-600
3KP220(C)	220	242	310.2	1.0	5	5	394	7.6	P-600
3KP220(C)A	220	242	281.6	1.0	5	5	356	8.4	P-600

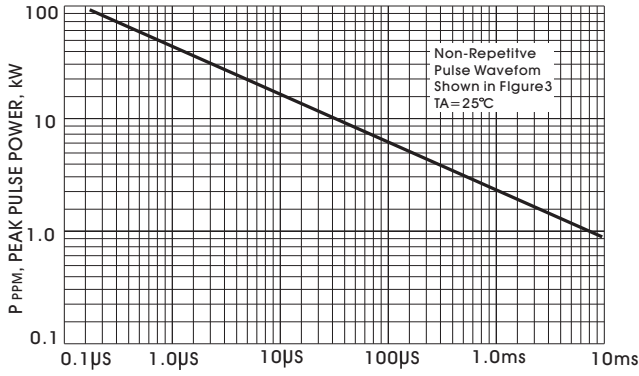

td, PULSE WIDTH, SEC
FIGURE 1-PEAK PULSE POWER VS PULSE TIME

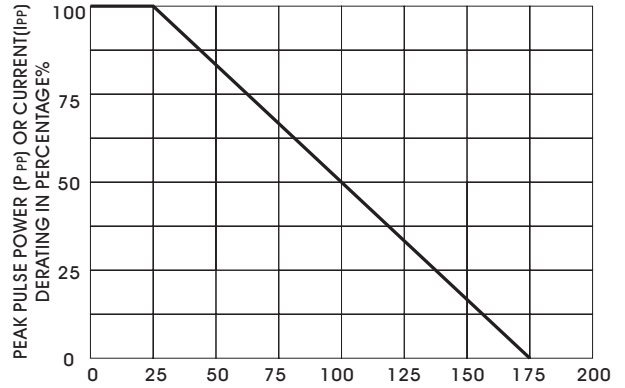

TA, AMBIENT TEMPERATURE, °C
FIGURE 2 DERATING CURVE

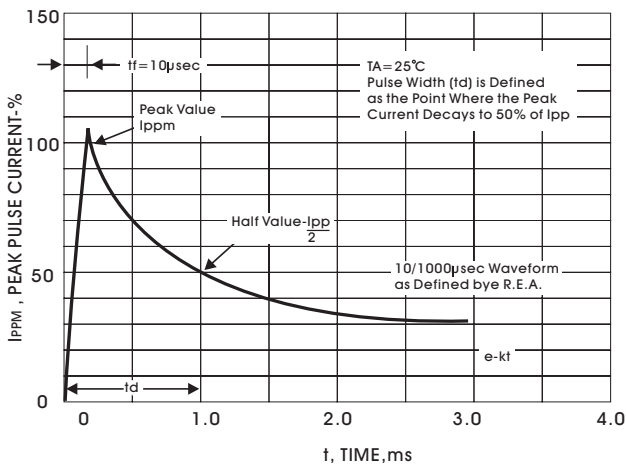

t, TIME, ms
FIGURE 3-PULSE WAVEFORM

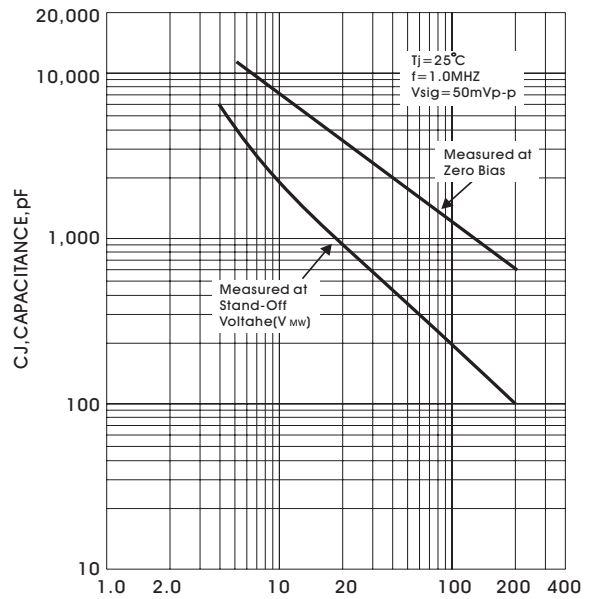

V(BR), BREAKDOWN VOLTAGE, VOLTS
FIGURE 4 TYPICAL CAPACITANCE VS STAND-OFF VOLTAGE

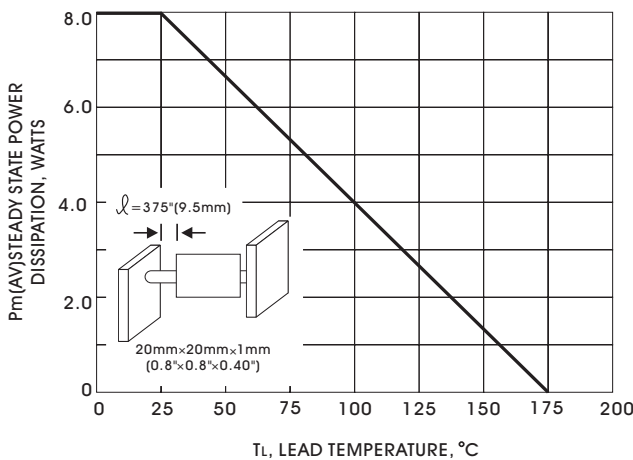

TL, LEAD TEMPERATURE, °C
FIG. 5-STEADY STATE POWER DERATING CURVE

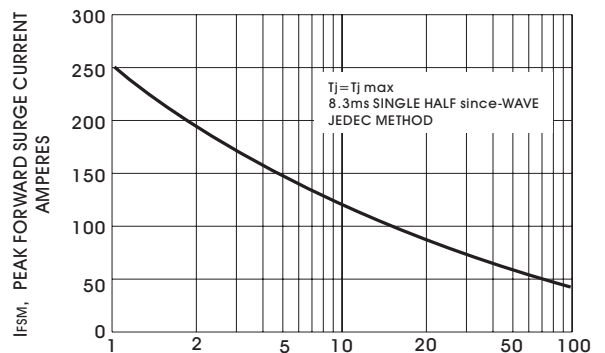

NUMBER OF CYCLES AT 60 Hz
FIG. 6-MAXIMUM NON-REPETITIVE PEAK FORWARD SURGE CURRENT UNIDIRECTIONAL