



Tuning Fork Quartz Crystals

32.768 kHz Plastic SMD

Technical Data

32S12 Series



Description

The 32S12 Series is a micro-miniature, plastic-molded, surface mountable version of the 32.768 kHz tuning fork-type quartz crystal. The crystal is housed in a rugged, high-temperature tubular holder, then mounted to a leadframe and injection molded into its plastic carrier. Two sizes and two lead connection configurations are available.

Applications & Features

- Very small, compact packaging
- Rugged, plastic-molded design, resistant to shock and vibration
- Excellent resistance to heat shock and environmental characteristics
- Ideally suited for automated pick-and-place assembly environments
- Available on tape and reel
- Ideal for portable applications, time of day clocks, communication equipment, pagers, cellular telephones, camcorders, and micro computers

Electrical Specifications

Nominal Frequency @ 25°C – F	32.768 kHz
Frequency Tolerance	±20 ppm
Turnover Temperature – T ₀	+25°C ±5°C
Temperature Coefficient – K	$(-3.5 \pm 0.8) \times 10^{-8} / ^\circ\text{C}^2$
Load Capacitance – C _L	12.5 pF standard
Equivalent Series Resistance – R _S	50KΩ max
Shunt Capacitance – C ₀	1.0 pF, typ
Recommended Drive Level - Pd	0.1μW
Maximum Drive Level – Pd _{MAX}	1μW max
Aging – ΔF / f (1st year @ 25°C ±3°C)	±5 ppm, max
Operating Temp. Range	-40 to +85°C
Storage Temp. Range	-55 to +125°C

Environmental / Process Specifications

High Temperature Storage:	Less than ±5 ppm change after 500H at 80°C
Low Temperature Storage:	Less than ±5 ppm change after 500H at -30°C
Thermal Shock:	Less than ±5 ppm change at 25°C after -25 to +80°C 20 cycles each 1 H
Shock:	MIL-STD-883, Method 2002, Condition B
Resistance to Soldering Heat:	MIL-STD-202, Method 210, Condition I or J Maximum of two (2) reflow passes
Solderability:	MIL-STD-883, Method 2003
Terminal Strength:	Will withstand pull weight of 500 grams, 30 seconds maximum

Part Numbering Guide

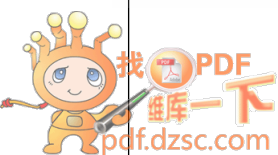
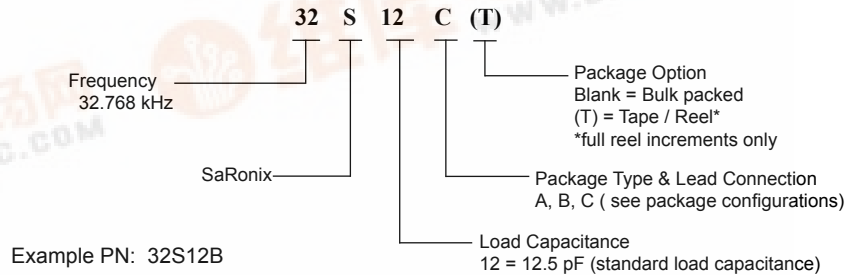

Technical Data

32S12 Series

Package Details

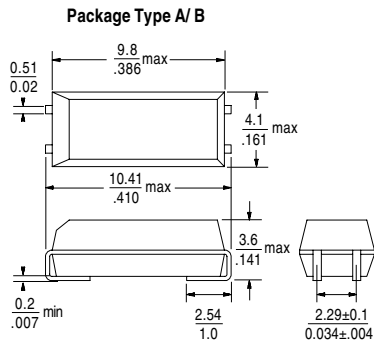

SOLDER PATTERN

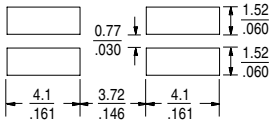

Package Type C

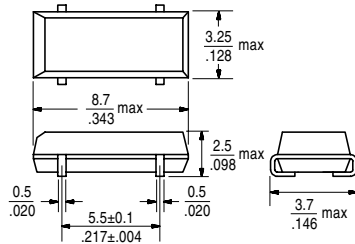

SOLDER PATTERN

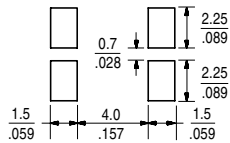

Tolerance: $\pm .13$
 $\pm .005$

Scale: None (Dimensions in $\frac{\text{mm}}{\text{inches}}$)

Marking Format

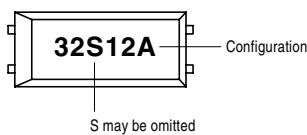

Frequency vs. Temperature Characteristics

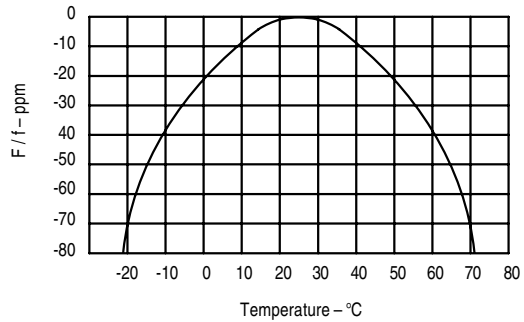

Solder Reflow Guide

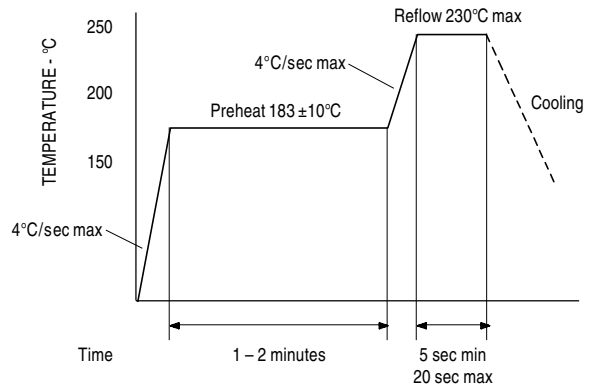

Lead Configurations

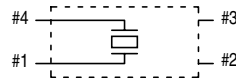

32S12A

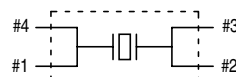

32S12B

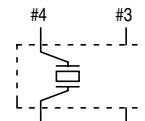

32S12C

**Note: for package A and C options, pins #2 and #3 provide mechanical support only. Do not connect to circuit.