

MODELS

694, 698, 699

Dual In-Line

Precision Thin Film

Resistor Networks



FEATURES

- **Unique passivation coating eliminates moisture concerns** and allows for use in applications traditionally restricted to tantalum nitride
- Outperforms other thin film resistor materials providing excellent tolerances, ratio matching, temperature coefficient, and temperature tracking
- Improved performance over silicon substrates in stray capacitance, frequency response and stability

ELECTRICAL

Operating Temperature Range	-55°C to +125°C
Resistance Voltco	≈0
Interlead Capacitance	<2pF
Operating Voltage, Maximum	100Vdc or √PR
Insulation Resistance	≥10,000 Megohms
Noise, Maximum (MIL-STD-202, Method 308)	-40dB

ENVIRONMENTAL (PER MIL-R-83401)

Thermal Shock plus Power Conditioning	ΔR ±0.25%
Short Time Overload	ΔR ±0.10%
Terminal Strength	ΔR ±0.10%
Moisture Resistance	ΔR ±0.20%
Mechanical Shock	ΔR ±0.25%
Vibration	ΔR ±0.25%
Low Temperature Storage	ΔR ±0.10%
High Temperature Exposure	ΔR ±0.10%
Load Life, 1,000 Hours	ΔR ±0.10%
Resistance to Solder Heat	ΔR ±0.10%
Dielectric Withstanding Voltage	200V rms for 1 minute
Marking Permanency	MIL-STD-202, Method 215
Lead Solderability	MIL-STD-202, Method 208
Flammability	UL-94V-0 Rated
Storage Temperature Range	-65°C to +125°C



ACCURACY CODES

Code	A	B	D	F
Absolute Resistance Tolerances, at 25°C	0.1%	0.1%	0.5%	1.0%
Ratio	0.05%	0.1%	0.1%	0.5%
Temperature Coefficient of Resistance				±50ppm/°C
Temperature Coefficient of Resistance, Tracking				±5ppm/°C

MECHANICAL

Lead Plating	60/40 Tin Lead (Dipped)
Lead Material	Copper Alloy
Substrate Material	Alumina
Resistor Material	Nichrome
Body Material	Molded Epoxy

SCHEMATICS

-1 Circuit - Bussed Resistors

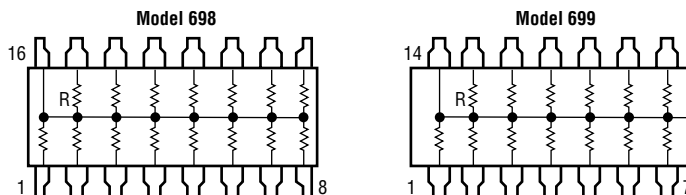

-3 Circuit - Isolated Resistors

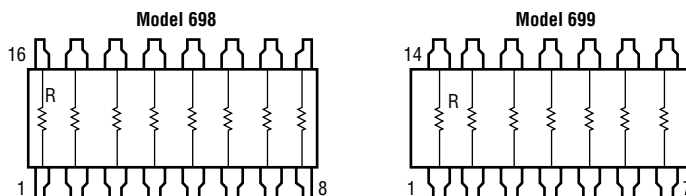

Model 694

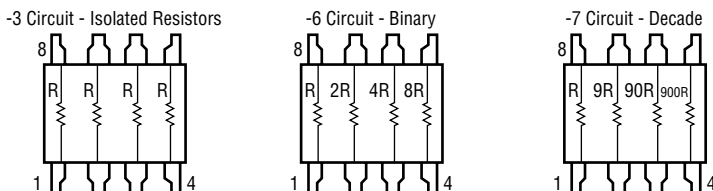

Note: Model 694, -6 & -7 circuits available only in accuracy code B: 0.1% absolute, 0.1% ratio.

OUTLINE DIMENSIONS (Inch/mm)

Model 699

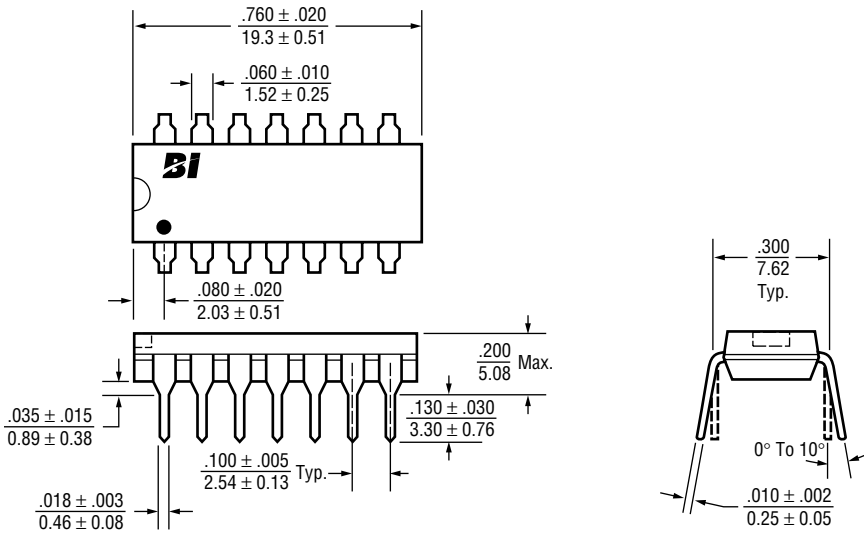

Model 699

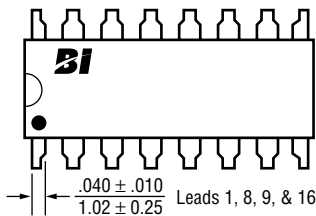

Model 699

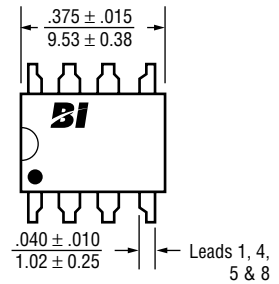

Note: Model 699 dimensions applicable to all models except as noted.

APPLICABLE DOCUMENTS

MIL-R-83401 — Resistor Networks, Fixed, Film, General Specifications

MIL-STD-202 — Test Methods for Electronic and Electrical Component Parts

POWER DERATING CURVE

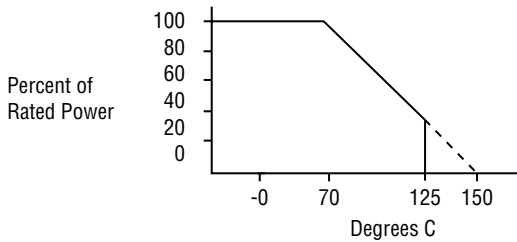

POWER (WATTS) DISSIPATION, AT 70°C

Model	Package	Resistor
694	0.4	0.15
698-1	0.6	0.05
698-3	0.6	0.10
699-1	0.6	0.05
699-3	0.6	0.10

STANDARD RESISTANCE VALUES, OHMS

694-1	11K	47K							
694-3:	100*	500*	1K*	2K*	5K*	10K*	20K*	50K	100K*
694-6:	1K	10K							
694-7:	1K								
698-1:	470	1K	2K	4.7K	10K	20K	22K	47K	100K
698-3:	100	330	470	1K*	1.5K	2K	2.2K	3.3K	4.7K
	5K	10K*	15K	20K*	22K	47K*	50K*	100K*	
699-1:	1K	437K	5K	10K	20K	50K	100K		
699-3:	1K	2K	3.3K	4.7K	5K	10K	20K	22K	47K
	50K	100K							

All values available in Accuracy Codes B, D, & F. except -6 or -7 circuits.

* Items with asterick are also available in Accuracy Code A.

Consult factory for additional values.

TYPICAL PART MARKING

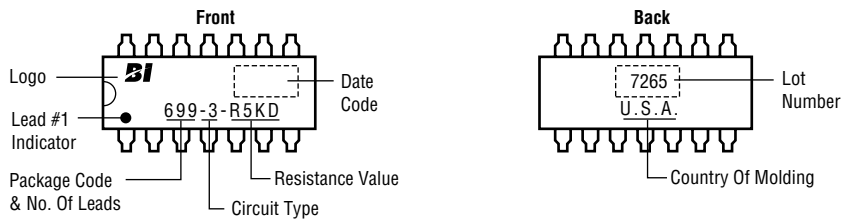

PACKAGING

Standard: Magazine

All units oriented with lead #1 to the same side.

Magazine:	Capacity	=	Units	Leads
			50	(8 leads)
			25	(16 leads)
			25	(14 leads)

ORDERING INFORMATION

