

# International IOR Rectifier

## 60EPU04PbF 60APU04PbF

### Ultrafast Soft Recovery Diode

#### Features

- Ultrafast Recovery
- 175°C Operating Junction Temperature
- Lead-Free ("PbF" suffix)

#### Benefits

- Reduced RFI and EMI
- Higher Frequency Operation
- Reduced Snubbing
- Reduced Parts Count

#### Description/ Applications

These diodes are optimized to reduce losses and EMI/ RFI in high frequency power conditioning systems. The softness of the recovery eliminates the need for a snubber in most applications. These devices are ideally suited for HF welding, power converters and other applications where switching losses are not significant portion of the total losses.



$t_{rr} = 50\text{ns (typ)}$
$I_{F(AV)} = 60\text{Amp}$
$V_R = 400\text{V}$

#### Absolute Maximum Ratings

Parameters	Max	Units
$V_R$ Cathode to Anode Voltage	400	V
$I_{F(AV)}$ Continuous Forward Current, $T_C = 127^\circ\text{C}$	60	A
$I_{FSM}$ Single Pulse Forward Current, $T_C = 25^\circ\text{C}$	600	
$I_{FRM} \text{①}$ Maximum Repetitive Forward Current	120	
$T_J, T_{STG}$ Operating Junction and Storage Temperatures	- 55 to 175	$^\circ\text{C}$

① Square Wave, 20kHz

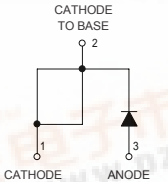
#### Case Styles

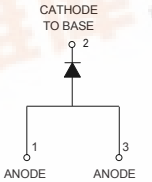
<p>60EPU04PbF</p>  <p>CATHODE TO BASE</p>  <p>CATHODE ANODE</p> <p>TO-247AC (Modified)</p>	<p>60APU04PbF</p>  <p>CATHODE TO BASE</p>  <p>ANODE ANODE</p> <p>TO-247AC</p>
--	---

**Electrical Characteristics @ T<sub>J</sub> = 25°C (unless otherwise specified)**

Parameters	Min	Typ	Max	Units	Test Conditions
V <sub>BR</sub> , V <sub>r</sub> Breakdown Voltage, Blocking Voltage	400	-	-	V	I <sub>R</sub> = 100μA
V <sub>F</sub> Forward Voltage	-	1.05	1.25	V	I <sub>F</sub> = 60A
	-	0.87	1.03	V	I <sub>F</sub> = 60A, T <sub>J</sub> = 175°C
	-	0.93	1.10	V	I <sub>F</sub> = 60A, T <sub>J</sub> = 125°C
I <sub>R</sub> Reverse Leakage Current	-	-	50	μA	V <sub>R</sub> = V <sub>R</sub> Rated
	-	-	2	mA	T <sub>J</sub> = 150°C, V <sub>R</sub> = V <sub>R</sub> Rated
C <sub>T</sub> Junction Capacitance	-	50	-	pF	V <sub>R</sub> = 400V
L <sub>S</sub> Series Inductance	-	3.5	-	nH	Measured lead to lead 5mm from package body

**Dynamic Recovery Characteristics @ T<sub>J</sub> = 25°C (unless otherwise specified)**

Parameters	Min	Typ	Max	Units	Test Conditions	
t <sub>rr</sub> Reverse Recovery Time	-	50	60	ns	I <sub>F</sub> = 1A, di <sub>F</sub> /dt = 200A/μs, V <sub>R</sub> = 30V  I <sub>F</sub> = 60A V <sub>R</sub> = 200V di <sub>F</sub> /dt = 200A/μs	
	-	85	-			T <sub>J</sub> = 25°C
	-	145	-			T <sub>J</sub> = 125°C
I <sub>RRM</sub> Peak Recovery Current	-	8.8	-	A	T <sub>J</sub> = 25°C	
	-	15.4	-		T <sub>J</sub> = 125°C	
Q <sub>rr</sub> Reverse Recovery Charge	-	375	-	nC	T <sub>J</sub> = 25°C	
	-	1120	-		T <sub>J</sub> = 125°C	

**Thermal - Mechanical Characteristics**

Parameters	Min	Typ	Max	Units
R <sub>thJC</sub> Thermal Resistance, Junction to Case			0.70	K/W
R <sub>thCS</sub> ② Thermal Resistance, Case to Heatsink		0.2		
Wt Weight		5.5		g
		0.2		(oz)
T Mounting Torque	1.2 (10)		2.4 (20)	N*m (lbf.in)
Marking Device	60EPU04, 60APU04			

② Mounting Surface, Flat, Smooth and Greased

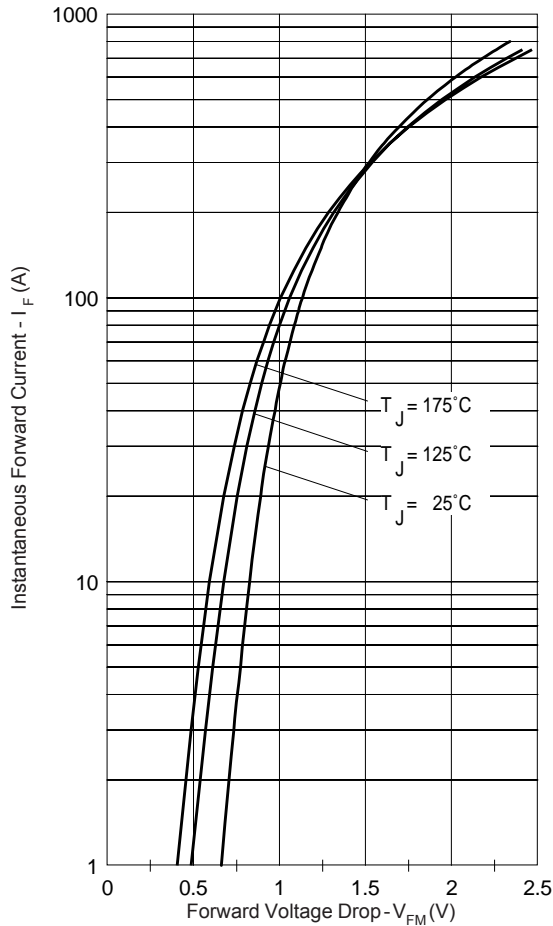

Fig. 1 - Typical Forward Voltage Drop Characteristics

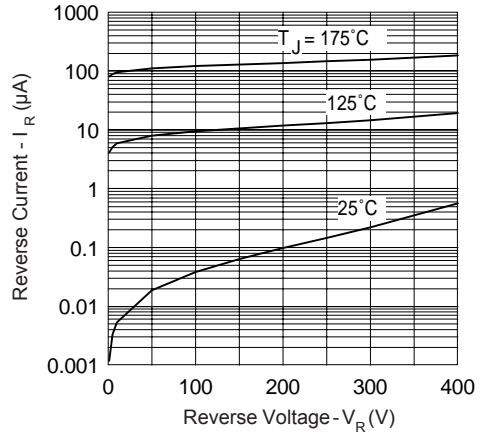

Fig. 2 - Typical Values Of Reverse Current Vs. Reverse Voltage

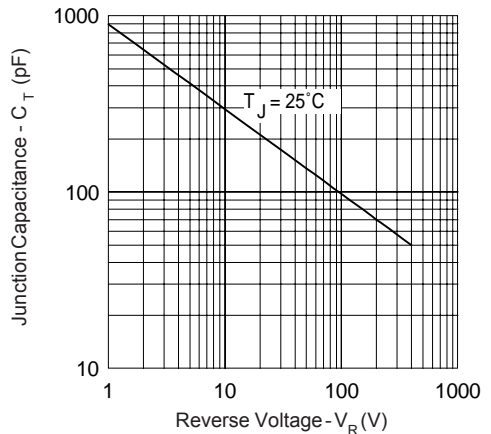

Fig. 3 - Typical Junction Capacitance Vs. Reverse Voltage

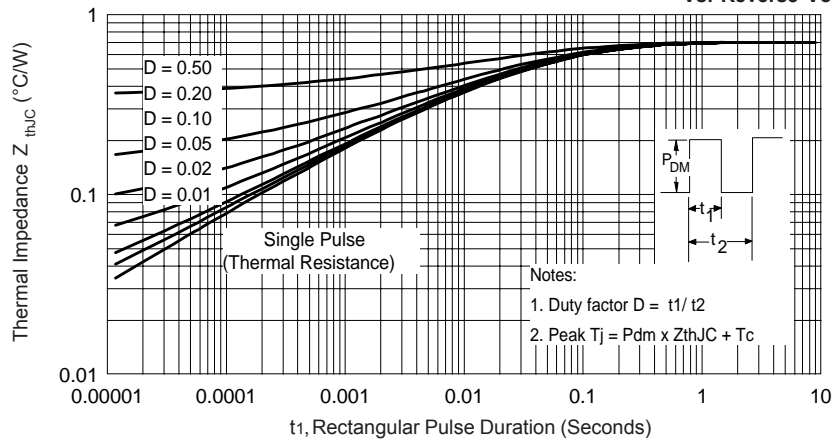
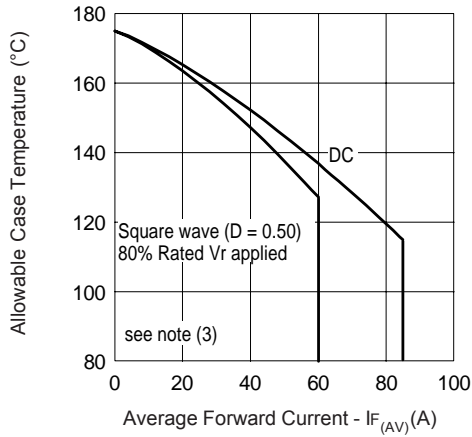
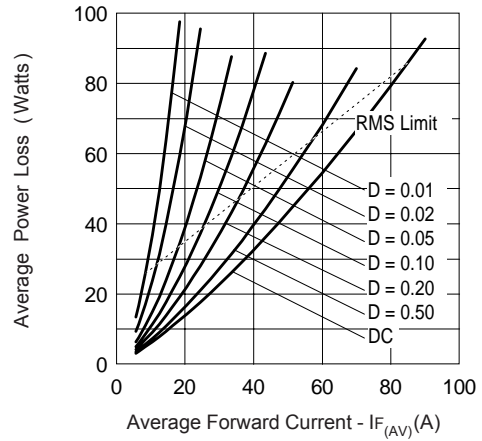

Fig. 4 - Max. Thermal Impedance  $Z_{thJC}$  Characteristics



**Fig. 5 - Max. Allowable Case Temperature Vs. Average Forward Current**



**Fig. 6 - Forward Power Loss Characteristics**

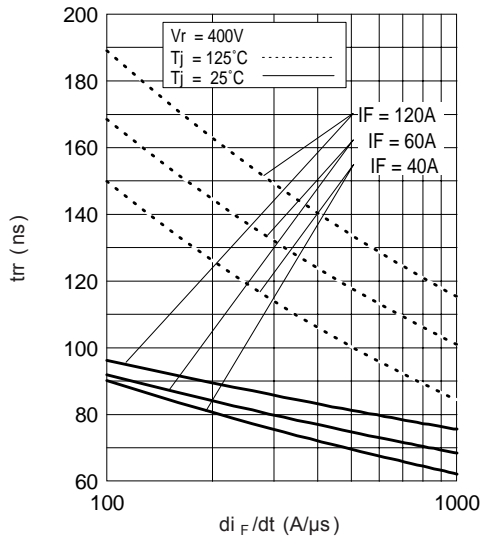

**Fig. 7 - Typical Reverse Recovery time vs. di<sub>F</sub>/dt**

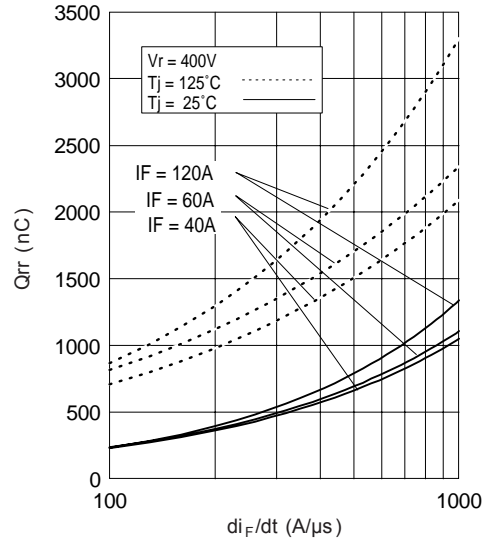

**Fig. 8 - Typical Stored Charge vs. di<sub>F</sub>/dt**

(3) Formula used:  $T_C = T_J - (P_d + P_{d_{REV}}) \times R_{thJC}$ ;

$P_d$  = Forward Power Loss =  $I_{F(AV)} \times V_{FM} @ (I_{F(AV)} / D)$  (see Fig. 6);

$P_{d_{REV}}$  = Inverse Power Loss =  $V_{R1} \times I_R (1 - D)$ ;  $I_R @ V_{R1} = 80\%$  rated  $V_R$

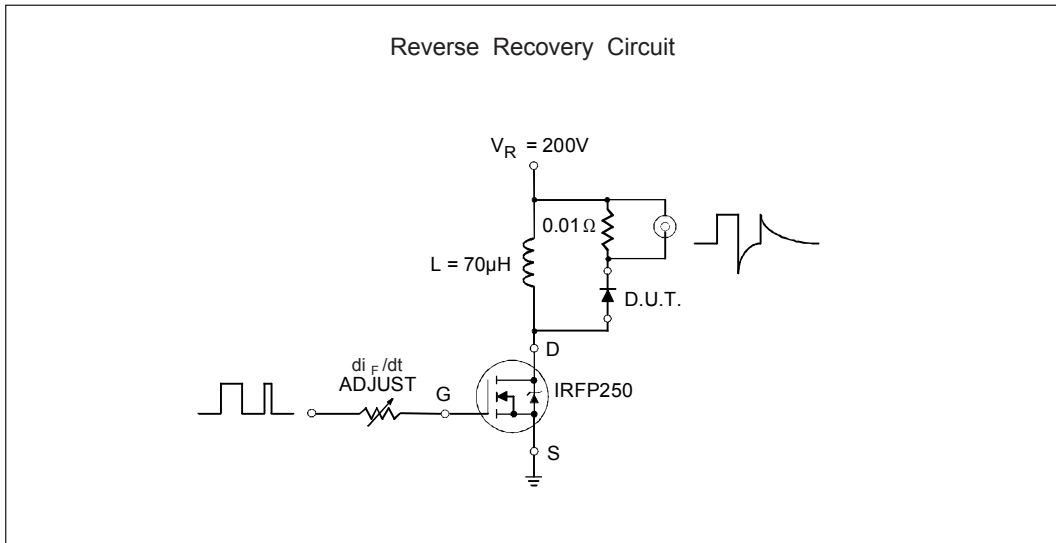

Fig. 9- Reverse Recovery Parameter Test Circuit

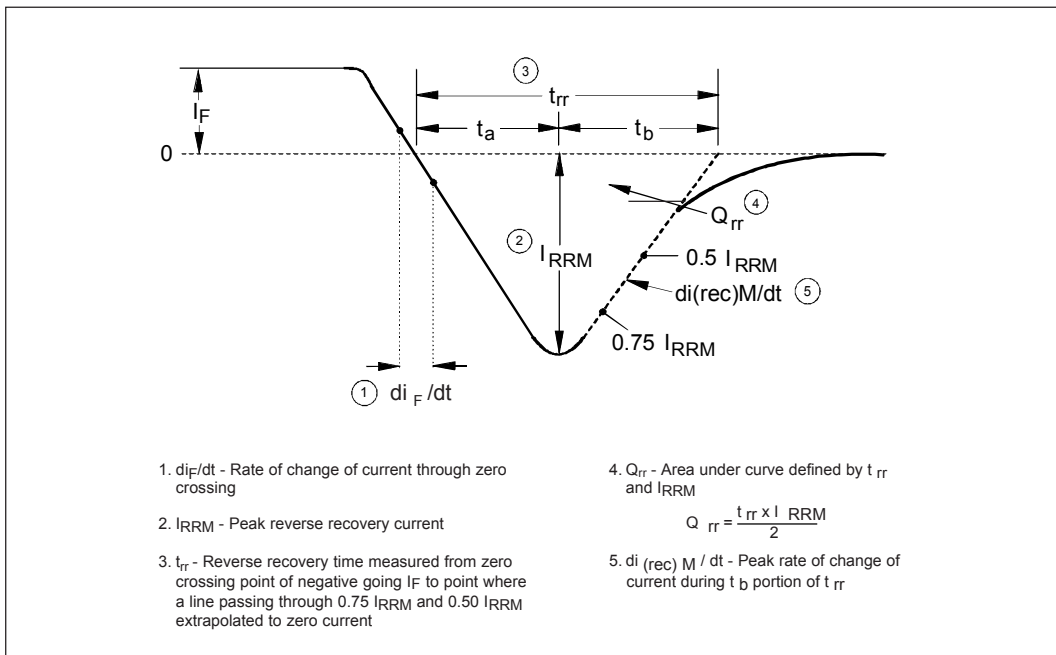
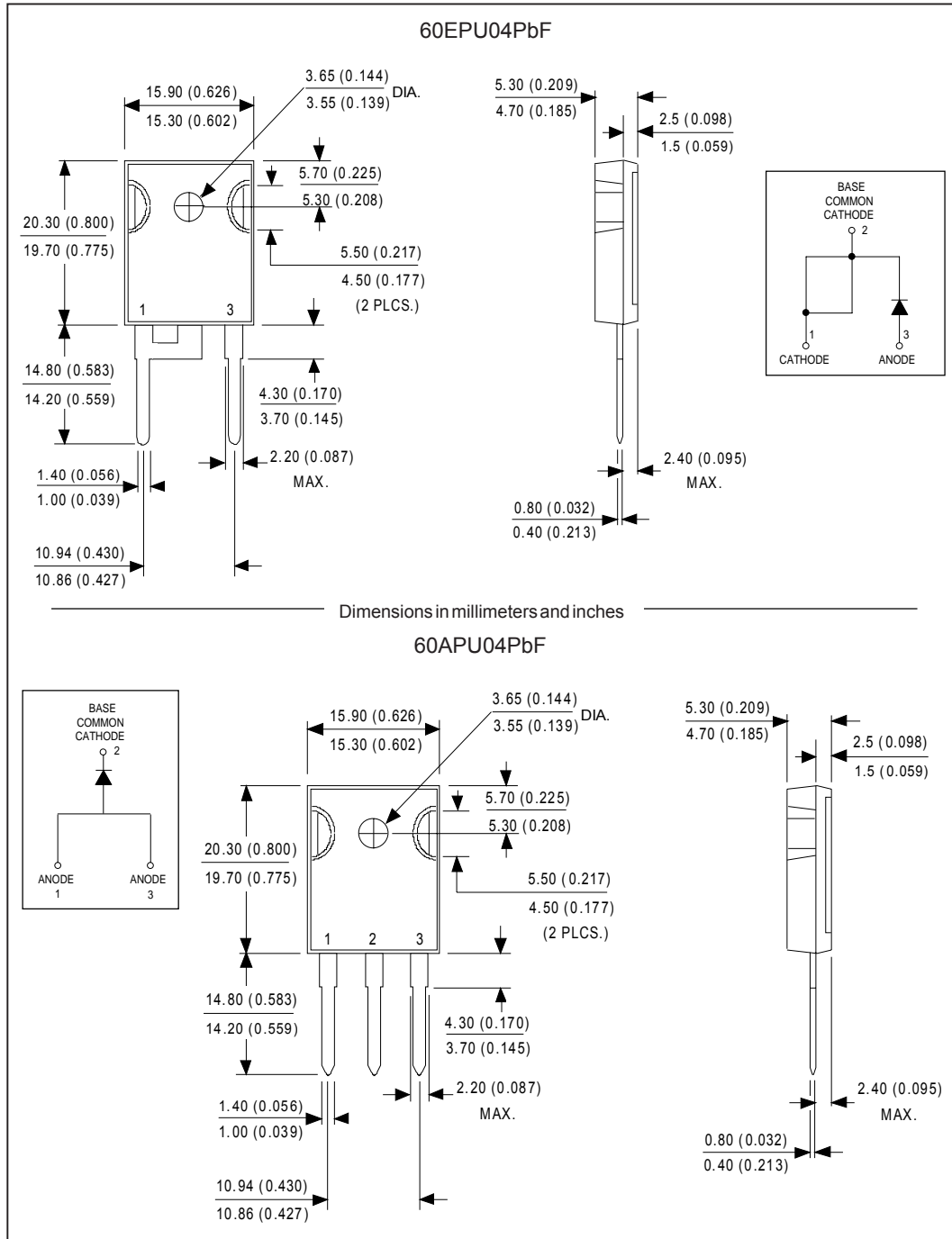

Fig. 10 - Reverse Recovery Waveform and Definitions

Outline Table



### Marking Information

EXAMPLE: THIS IS A 60EPU04  
 WITH ASSEMBLY  
 LOT CODE 5657  
 ASSEMBLED ON WW 35, 2000  
 IN ASSEMBLY LINE "H"

PART NUMBER

INTERNATIONAL RECTIFIER LOGO

ASSEMBLY LOT CODE

DATE CODE  
 P = LEAD-FREE  
 YEAR 0 = 2000  
 WEEK 35  
 LINE H

EXAMPLE: THIS IS A 60APU04  
 WITH ASSEMBLY  
 LOT CODE 5657  
 ASSEMBLED ON WW 35, 2000  
 IN ASSEMBLY LINE "H"

PART NUMBER

INTERNATIONAL RECTIFIER LOGO

ASSEMBLY LOT CODE

DATE CODE  
 P = LEAD-FREE  
 YEAR 0 = 2000  
 WEEK 35  
 LINE H

### Ordering Information Table

Device Code	60	E	P	U	04	PbF
	①	②	③	④	⑤	⑥
<b>1</b>	-	Current Rating (60 = 60A)				
<b>2</b>	-	Circuit Configuration:	E = Single Diode	A = Single Diode, 3 pins		
<b>3</b>	-	Package:	P = TO-247AC (Modified)			
<b>4</b>	-	Type of Silicon:	U = UltraFast Recovery			
<b>5</b>	-	Voltage Rating (04 = 400V)				
<b>6</b>	-	• none = Standard Production	• PbF = Lead-Free			

60EPU04PbF, 60APU04PbF

Bulletin PD-21080 08/05

International  
**IOR** Rectifier

Data and specifications subject to change without notice.  
This product has been designed and qualified for Industrial Level and Lead-Free.  
Qualification Standards can be found on IR's Web site.

International  
**IOR** Rectifier

**IR WORLD HEADQUARTERS:** 233 Kansas St., El Segundo, California 90245, USA Tel: (310) 252-7105  
TAC Fax: (310) 252-7309

Visit us at [www.irf.com](http://www.irf.com) for sales contact information. 08/05