

6146B/8298A

查询8298A供应

捷多邦, 专业

商

Beam Power Tube

PCB打样工厂
24小时加急出

HIGH POWER SENSITIVITY

RCA "DARK HEATER" WITH 5- TO 8-VOLT RANGE

85 WATTS CW INPUT (ICAS)

UP TO 60 Mc

CONTROLLED ZERO-BIAS

PLATE CURRENT

50 WATTS CW INPUT (ICAS)

AT 175 Mc

CONTROLLED POWER OUTPUT

AT REDUCED HEATER VOLTAGE

For RF Power Amplifier and Oscillator Service and as an AF Power Amplifier and Modulator in Both Mobile and Fixed Equipment. The 6146B/8298A is Unilaterally Interchangeable with types 6146, 6146A, and 8298.

Electrical:

Heater, for Unipotential Cathode:

Voltage (AC or DC)	6.3	volts
Current at heater volts = 6.3	1.125	amp
Minimum heating time	60	sec

(See *Special Performance Data* for heater operation in stationary and mobile equipment)

Transconductance, for plate volts = 200, grid-No.2 volts = 200, and plate ma. = 100 7000 μ mhos

Mu-Factor, Grid No.2 to Grid No.1 for plate volts = 200, grid-No.2 volts = 200, and plate ma. = 100. 4.5

Direct Interelectrode Capacitances:^a
Grid No.1 to plate 0.22 max. pf

Grid No.1 to cathode & grid No.3 & internal shield, grid No.2, base sleeve, and heater. 13.0 pf

Plate to cathode & grid No.3 & internal shield, grid No.2, base sleeve, and heater. 8.5 pf

Mechanical:

Operating Position Any

Maximum Overall Length 3-13/16"

Seated Length. 3-1/8" \pm 1/8"

Maximum Diameter 1-21/32"

Weight (Approx.) 2.3 oz

Bulb T12

Cap. Small (JEDEC No.C1-1)

Bases (Alternates):

Small-Wafer Octal with Sleeve:

8-Pin (JEDEC Group 1, No.B8-150)

Small-Wafer Octal with External Barriers and Sleeve:

8-Pin (JEDEC Group 1, No.B9-159)



6146B/8298A

Basing Designation for BOTTOM VIEW. 7CK

Pin 1 - Cathode,
Grid No. 3,
Internal
Shield

Pin 2 - Heater

Pin 3 - Grid No. 2

Pin 4 - Same as Pin 1

Pin 5 - Grid No. 1

Pin 6 - Same as Pin 1

Pin 7 - Heater

Pin 8 - Base Sleeve

Cap - Plate

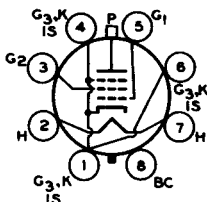

Bulb Temperature (At hottest point
on bulb surface). 260 max. °C

AF POWER AMPLIFIER & MODULATOR — Class AB₁^b

CCS^c

ICAS^d

Maximum Ratings, Absolute-Maximum Values:

DC Plate Voltage	600 max.	750 max.	volts
DC Grid-No.2 Voltage	250 max.	250 max.	volts
Max.-Signal DC Plate Current ^e	175 max.	220 max.	ma
Max.-Signal Plate Input ^e	90 max.	120 max.	watts
Max.-Signal Grid-No.2 Input ^e	3 max.	3 max.	watts
Plate Dissipation ^e	27 max.	35 max.	watts
Peak Heater-Cathode Voltage:			
Heater negative with respect to cathode	135 max.	135 max.	volts
Heater positive with respect to cathode	135 max.	135 max.	volts

Typical Push-Pull Operation:

Values are for 2 tubes

DC Plate Voltage	600	750	volts
DC Grid-No.2 Voltage ^f	200	200	volts
DC Grid-No.1 Voltage:			
With fixed-bias source	-47	-48	volts
Peak AF Grid-No.1-to-			
Grid-No.1 Voltage ^g	94	96	volts
Zero-Signal DC Plate Current	48	50	ma
Max.-Signal DC Plate Current	250	250	ma
Max.-Signal DC Grid No.2			
Current	14.8	12.6	ma
Effective Load Resistance			
(Plate to plate)	5600	7200	ohms
Max.-Signal Driving			
Power (Approx.)	0	0	watts
Max.-Signal Power			
Output (Approx.)	96	124	watts

6146B/8298A

Maximum Circuit Values (CCS or ICAS):

Grid-No.1-Circuit Resistance
under Any Condition:^h

With fixed bias.	0.1 max.	megohm
With cathode bias.	Not recommended	

AF POWER AMPLIFIER & MODULATOR — Class AB₂^j

CCS

ICAS

Maximum Ratings, Absolute-Maximum Values:

DC Plate Voltage	600 max.	750 max.	volts
DC Grid-No.2 Voltage	250 max.	250 max.	volts
Max.-Signal DC Plate Current ^e	175 max.	220 max.	ma
Max.-Signal Plate Input ^e	90 max.	120 max.	watts
Max.-Signal Grid-No.2 Input ^e	3 max.	3 max.	watts
Plate Dissipation ^e	27 max.	35 max.	watts
Peak Heater-Cathode Voltage:			
Heater negative with respect to cathode	135 max.	135 max.	volts
Heater positive with respect to cathode	135 max.	135 max.	volts

Typical Push-Pull Operation:

Values are for 2 tubes

DC Plate Voltage.	500	600	600	750	volts
DC Grid-No.2 Voltage ^f	200	200	200	150	volts
DC Grid-No.1 Voltage:					
From fixed-bias source.	-46	-48	-47	-39	volts
Peak AF Grid-No.1-to- Grid No.1 Voltage	108	106	114	110	volts
Zero-Signal DC Plate Current	50	40	50	40	ma
Max.-Signal DC Plate Current	308	270	328	294	ma
Max.-Signal DC Grid No.2 Current	26	27	26	28	ma
Max.-Signal DC Grid No.1 Current	2.7	1.3	3.4	7.6	ma
Effective Load Resistance (Plate to plate).	3620	5200	4160	6050	ohms
Max.-Signal Driving Power (Approx.) ^k	0.2	0.7	0.2	0.5	watt
Max.-Signal Power Output (Approx.)	100	110	130	148	watts

Maximum Circuit Values (CCS or ICAS):

Grid-No.1-Circuit Resistance:^m

With fixed bias	30000 max.	ohms
With cathode bias	Not recommended	

6146B/8298A

LINEAR RF POWER AMPLIFIER — Class AB₁ Single-Sideband Suppressed-Carrier Service

Peak envelope conditions for a signal having a minimum peak-to-average power ratio of 2

CCS ICAS

Maximum Ratings, Absolute-Maximum Values:

DC Plate Voltage.	600 max.	750 max.	volts
DC Grid-No.2 Voltage.	250 max.	250 max.	volts
DC Plate Current at Peak of Envelope	175 max.	220 max.	ma
Plate Dissipation	27 max.	35 max.	watts
Grid-No.2 Dissipation	3 max.	3 max.	watts
Peak Heater-Cathode Voltage:			
Heater negative with respect to cathode.	135 max.	135 max.	volts
Heater positive with respect to cathode.	135 max.	135 max.	volts

Typical Operation with "Two-Tone Modulation":

At 30 Mc

DC Plate Voltage.	600	750	volts
DC Grid-No.2 Voltage ^D	200	200	volts
DC Grid-No.1 Voltage ^D	-47	-48	volts
Zero-Signal DC Plate Current.	24	25	ma
Effective RF Load Resistance.	2800	3600	ohms
DC Plate Current at Peak of Envelope	125	125	ma
Average DC Plate Current.	86	86	ma
DC Grid-No.2 Current at Peak of Envelope.	7.4	6.3	ma
Average DC Grid-No.2 Current.	5	3.9	ma
Distortion Products Level: ^P			
Third order	24	26	db
Fifth order	30	31	db
Useful Power Output (Approx.):			
Average	24.5	30.5	watts
Peak envelope	49	61	watts

Maximum Circuit Values:

Grid-No.1 Circuit Resistance under Any Condition:			
With fixed bias	30000 max.		ohms

PLATE-MODULATED RF POWER AMPLIFIER — Class C Telephony

Carrier conditions per tube for use with a maximum modulation factor of 1; at frequencies up to 60 Mc

CCS ICAS

Maximum Ratings, Absolute-Maximum Values:

For maximum plate voltage and maximum plate input above 60 Mc, see Rating Chart I

DC Plate Voltage.	480 max.	600 max.	volts
DC Grid-No.2 Voltage	250 max.	250 max.	volts

6146B/8298A

	CCS	ICAS	
DC Grid-No.1 Voltage.	-150 max.	-150 max.	volts
DC Plate Current.	145 max.	180 max.	ma
DC Grid-No.1 Current.	3.5 max.	4 max.	ma
Plate Input	60 max.	85 max.	watts
Grid-No.2 Input	2 max.	2 max.	watts
Plate Dissipation	18 max.	23 max.	watts
Peak Heater-Cathode Voltage:			
Heater negative with respect to cathode.	135 max.	135 max.	volts
Heater positive with respect to cathode.	135 max.	135 max.	volts

Typical Operation:

DC Plate Voltage.	475	600	volts
DC Grid-No.2 Voltage ^a	165	175	volts
DC Grid-No.1 Voltage: ^r			
From a grid-No.1 resistor of:			
26000 ohms.	-86	-	volts
27000 ohms.	-	-92	volts
Peak RF Grid-No.1 Voltage	106	114	volts
DC Plate Current.	125	140	ma
DC Grid-No.2 Current.	8.5	9.5	ma
DC Grid-No.1 Current (Approx.)	3.3	3.4	ma
Driving Power (Approx.)	0.4	0.5	watt
Power Output (Approx.)	42	62	watts

Maximum Circuit Values (CCS or ICAS):

Grid-No.1-Circuit Resistance ^s	30000 max.		ohms
---	------------	--	------

**RF POWER AMPLIFIER & OSCILLATOR — Class C Telegraphy and
RF POWER AMPLIFIER — Class C FM Telephony**

	CCS	ICAS	
Maximum Ratings, Absolute-Maximum Values:			
<i>At frequencies up to 60 Mc. For maximum plate voltage and maximum plate input above 60 Mc, see Rating Chart II</i>			
DC Plate Voltage.	600 max.	750 max.	volts
DC Grid-No.2 Voltage.	250 max.	250 max.	volts
DC Grid-No.1 Voltage.	-150 max.	-150 max.	volts
DC Plate Current.	175 max.	220 max.	ma
DC Grid-No.1 Current.	3.5 max.	4 max.	ma
Plate Input	90 max.	120 max.	watts
Grid-No.2 Input	3 max.	3 max.	watts
Plate Dissipation	27 max.	35 max.	watts
Peak Heater-Cathode Voltage:			
Heater negative with respect to cathode.	135 max.	135 max.	volts
Heater positive with respect to cathode.	135 max.	135 max.	volts

6146B/8298A

Typical Operation:

	CCS	ICAS	
<i>As amplifier up to 60 Mc</i>			
DC Plate Voltage.	600	750	volts
DC Grid-No.2 Voltage ^t	200	200	volts
DC Grid-No.1 Voltage: ^u			
From a grid-No.1 resistor of:			
24000 ohms.	-70	-	volts
28000 ohms.	-	-77	volts
Peak RF Grid-No.1 Voltage	90	95	volts
DC Plate Current.	150	160	ma
DC Grid-No.2 Current.	10	10	ma
DC Grid-No.1 Current (Approx.).	2.8	2.7	ma
Driving Power (Approx.)	0.3	0.3	watt
Power Output (Approx.)	63	85	watts

Typical Operation:

	<i>As amplifier up to 175 Mc</i>			
DC Plate Voltage.	320	400	435	volts
DC Grid-No.2 Voltage ^t	210	220	230	volts
DC Grid-No.1 Voltage: ^u				
From a grid-No.1 resistor of:				
26000 ohms.	-52	-	-	volts
30000 ohms.	-	-55	-	volts
24000 ohms.	-	-	-56	volts
Peak RF Grid-No.1 Voltage	65	67	73	volts
DC Plate Current.	170	180	210	ma
DC Grid-No.2 Current.	12	12	11	ma
DC Grid-No.1 Current (Approx.).	2	1.9	2.3	ma
Driving Power (Approx.)	2	2	3	watts
Power Output (Approx.)	29	40	50	watts

Maximum Circuit Values (CCS or ICAS):

Grid-No.1-Circuit Resistance ^a	30000 max.	ohms
---	------------	------

^a with no external shield.

^b Subscript 1 indicates that grid-No.1 current does not flow during any part of the input cycle.

^c Continuous Commercial Service

^d Intermittent Commercial and Amateur Service.

^e Averaged over any audio-frequency cycle of sine-wave form.

^f obtained preferably from a separate source or from the plate voltage supply with a voltage divider.

^g The driver stage should be capable of supplying the No.1 grids of the class AB₁ stage with the specified driving voltage at low distortion.

^h The type of input coupling network used should not introduce too much resistance in the grid-No.1 circuit. Transformer or impedance coupling devices are recommended.

^j Subscript 2 indicates that grid-No.1 current flows during some part of the input cycle.

^k Driver stage should be capable of supplying the specified driving power at low distortion to the No.1 grids of the AB₂ stage.

^m To minimize distortion, the effective resistance per grid-No.1 circuit of the AB₂ stage should be held at a low value. For this purpose the use of transformer coupling is recommended. In no case, however, should the total dc grid-No.1-circuit resistance exceed 30,000 ohms when the tube is operated at maximum ratings. For operation at less than maximum ratings, the dc grid-No.1-circuit resistance may be as high as

6146B/8298A

- ⁿ Obtained preferably from a separate, well-regulated source.
- ^p Referenced to either of the two tones and without the use of feedback to enhance linearity.
- ^q Obtained preferably from a separate source modulated with the plate supply, or from the modulated plate supply through a series resistor.
- ^r Obtained from grid-No.1 resistor or from a combination of grid-No.1 resistor with either fixed supply or cathode resistor.
- ^s When grid No.1 is driven positive and the tube is operated at maximum ratings, the total dc grid-No.1-circuit resistance should not exceed the specified value of 30,000 ohms. If this value is insufficient to provide adequate bias, the additional required bias must be supplied by a cathode resistor or fixed supply. For operation at less than maximum ratings, the dc grid-No.1-circuit resistance may be as high as 100,000 ohms.
- ^t Obtained preferably from separate source, or from the plate-supply voltage with a voltage divider, or through a series resistor. A series grid-No.2 resistor should be used only when the tube is used in a circuit which is not keyed. Grid-No.2 voltage must not exceed 435 volts under key-up conditions.
- ^u Obtained from fixed-supply, by grid-No.1 resistor, by cathode resistor, or by combination methods.

CHARACTERISTICS RANGE VALUES

Test No.		Note	Min.	Max.	
1.	Direct Interelectrode Capacitances:				
	Grid No.1 to plate	1	-	0.22	pf
	Grid No.1 to cathode & grid No.3 & internal shield, base sleeve, grid No.2, and heater. .	1	12.0	15.0	pf
	Plate to cathode & grid No.3 & internal shield, base sleeve, grid No.2, and heater	1	7.3	9.5	pf
2.	Plate Current.	2	46	94	ma
3.	Zero-Bias Plate Current. . .	3	330	-	ma
4.	Grid-No.2 Current.	2	-	5.5	ma

Note 1: With no external shield.

Note 2: With heater voltage of 6.75 volts, dc plate voltage of 400 volts, dc grid-No.2 voltage of 200 volts, and dc grid-No.1 voltage of -34 volts.

Note 3: With heater voltage of 6.75 volts, dc plate voltage of 100 volts, dc grid-No.2 voltage of 200 volts, and dc grid-No.1 voltage of -100 volts. Grid No.1 is square-wave pulsed at 1000 kc to zero volts. Limit value is peak-pulse current.

SPECIAL PERFORMANCE DATA

Stationary Equipment Operation:

	Min.	Design Center	Max.	
Heater, for Unipotential Cathode:				
Voltage (AC or DC) ^v	-	6.3	-	volts
Current at 6.3 volts.	1.050	-	1.200	amp
Dynamic Grid-No.2 Current ^w . . .	-	-	15	ma
Useful Power Output ^w	59	-	-	watts

6146B/8298A

^V It is recommended that the design-center heater voltage be 6.3 volts; the heater power supply should not fluctuate more than 10% to insure long life.

^W In a single-tube, self-excited oscillator circuit, and with ac heater voltage of 6.3 volts, dc plate voltage of 600 volts, dc grid-No.2 voltage of 200 volts, grid-No.1 resistor of $24,000 \pm 10\%$ ohms, dc plate current of 150 max. ma., dc grid-No.1 current of 2.5 to 3 ma., and frequency of 15 Mc.

Mobile Equipment Operation:

	Min.	Design Range	Max.	
Heater, for Unipotential Cathode:				
Voltage (AC or DC) ^x	-	6.0-7.5	-	volts
Current at 6.75 volts.	1.100	-	1.230	amp
Dynamic Grid-No.2 Current ^y	-	-	15	ma
Useful Power Output I ^y	59			watts
Useful Power Output II		See Note Z		

Overvoltage Heater Life Tests:

Continuous heater life tests are performed periodically on sample lots of tubes with 8 volts on the heater, all other electrodes "floating". Intermittent heater life tests are performed periodically on sample lots of tubes with 11 volts on the heater, a cycle of 1 minute "ON" and 4 minutes "OFF". After 1000 hours of the continuous heater life test and after 48 hours of the intermittent heater life test, the following tests are performed:

With heater voltage of 6.75 volts and ± 100 dc volts between cathode and heater, the heater-cathode leakage current will not exceed 100 microamperes.

With ac or dc heater voltage of 6.75 volts, grid-No.1 volts = -200 and cathode, grid No.2, and plate grounded, the minimum grid-No.1 leakage resistance will be 10 megohms.

With ac or dc heater voltage of 6.75 volts, plate volts = -200, and cathode grid No.1 and grid No.2 grounded, the minimum plate leakage resistance will be 10 megohms.

^X It is recommended that the heater voltage operate within the range of 6.0 to 7.5 volts and within excursions from 5 to 8 volts in battery operation. See *Useful Power Output Test II* and *Overvoltage Tests*.

^Y In a single-tube, self-excited oscillator circuit, and with ac heater voltage of 6.3 volts, dc plate voltage of 600 volts, dc grid-No.2 voltage of 200 volts, grid-No.1 resistor of $24,000 \pm 10\%$ ohms, dc plate current of 150 max. ma., dc grid-No.1 current of 2.5 to 3 ma., and frequency of 15 Mc.

^Z With conditions in note (y) above, reduce heater voltage to 5 volts. Useful power output will be at least 90% of the power output at heater voltage of 6.3 volts.

OPERATING CONSIDERATIONS

The maximum bulb temperature of 260^o C is a tube rating and is to be observed in the same manner as other ratings. The temperature may be measured with temperature-sensitive paint, such as Tempilaq. The latter is made by the Tempil Corporation, 132 W. 22nd Street, New York 11, N.Y.

6146B/8298A

To insure adequate cooling it is essential that free circulation of air be provided around the tube. In most cases, no additional air is required.

The plate shows no color when the 6146B/8298A is operated at full ratings under either CCS or ICAS conditions.

Connections to the plate should be made with a flexible lead to prevent any strain on the seal at the cap.

During standby periods in intermittent operation, it is recommended that the heater voltage be maintained at normal operating value when the period is less than 15 minutes, and that it be reduced to 80 per cent of normal when the period is between 15 minutes and 2 hours. For longer periods, the heater voltage should be turned off.

The maximum-rated plate and grid-No. 2 voltages of this tube are extremely dangerous. Great care should be taken during the adjustment of circuits. The tube and its associated apparatus, especially all parts which may be at high potential above ground, should be housed in a protective enclosure. The protective housing should be designed with interlocks so that personnel can not possibly come in contact with any high-potential point in the electrical system. The interlock devices should function to break the primary circuit of the high-voltage supplies when any gate or door on the protective housing is opened, and should prevent the closing of the primary circuit until the door is again locked.

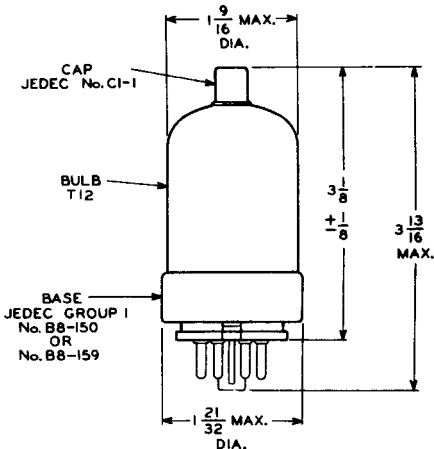

92CS-12249R1

DIMENSIONS IN INCHES

6146B/8298A

RATING CHART I Class C Telephony Service

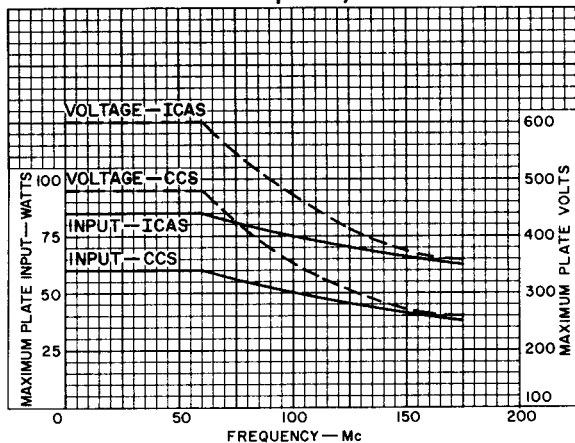

92CS-12244

RATING CHART II Class C Telegraphy Service

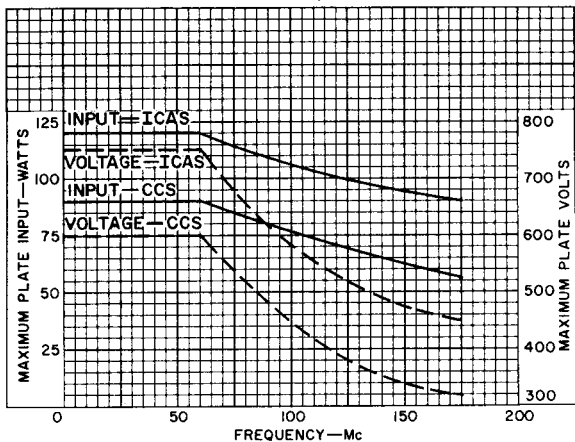

92CS-12243

6146B/8298A

TYPICAL PLATE CHARACTERISTICS

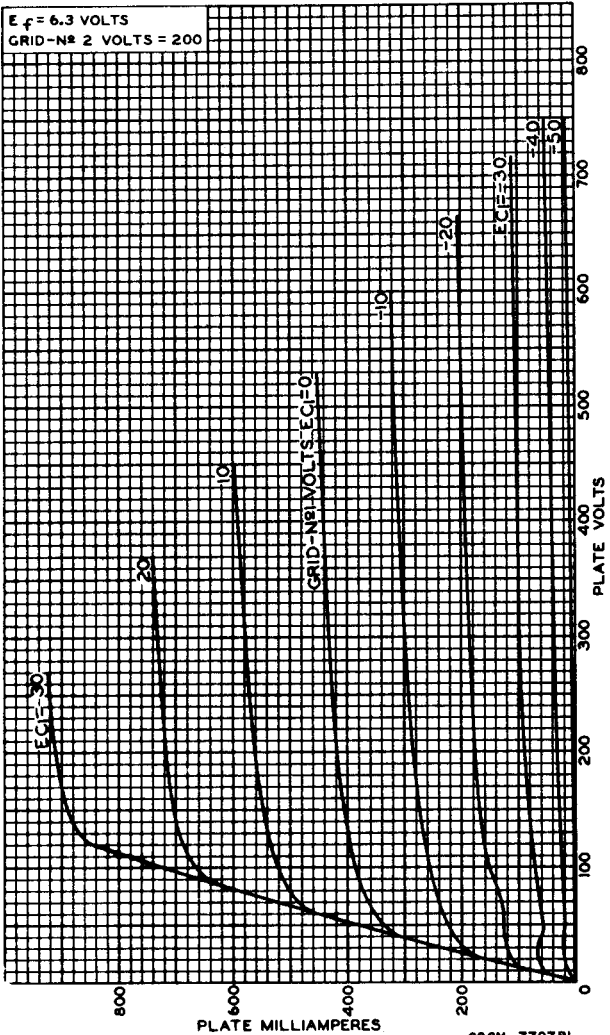

6146B/8298A

TYPICAL PLATE CHARACTERISTICS

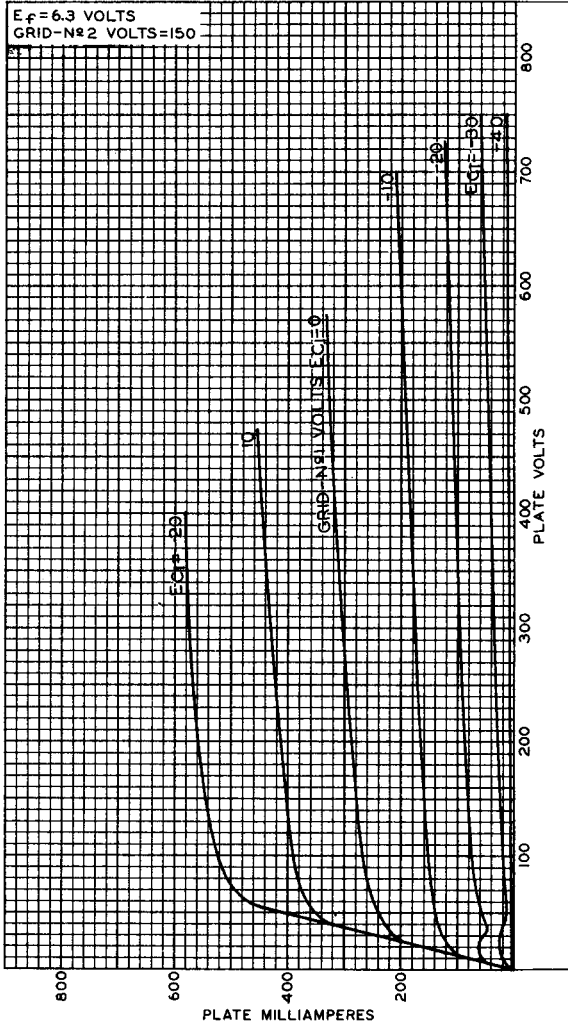

6146B/8298A

TYPICAL CHARACTERISTICS

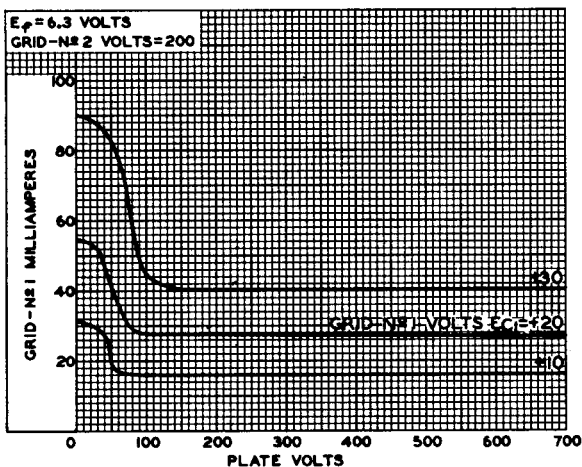

92CS-9617

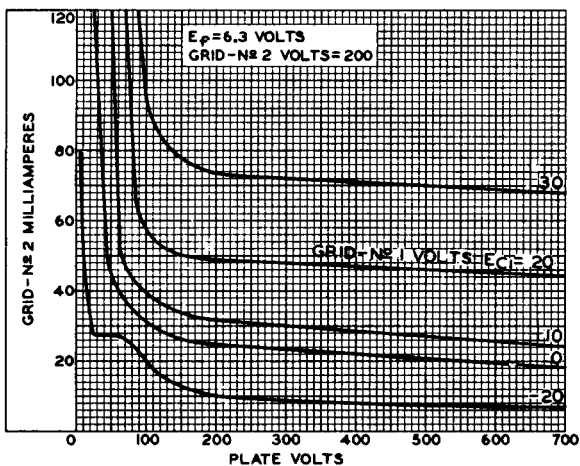

92CS-9618

6146B/8298A

TYPICAL CHARACTERISTICS

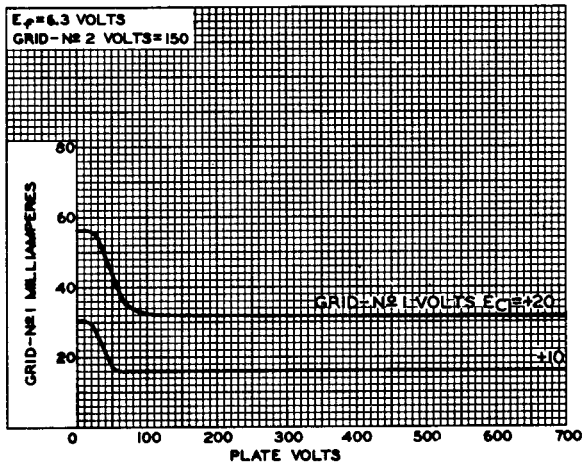

92CS-9619

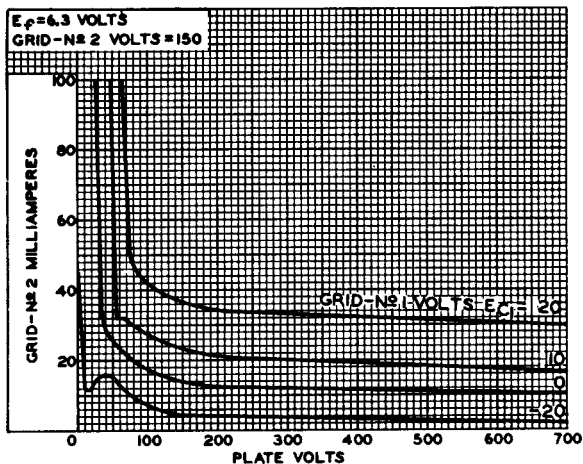

92CS-9620