



# Part Number 855094

## 325 MHz SAW Filter

### Preliminary Data Sheet

#### Features

- For broadband applications
- Typical 3 dB bandwidth of 10 MHz
- Single-ended or differential operation
- Ceramic Surface Mount Package (SMP)
- Small size

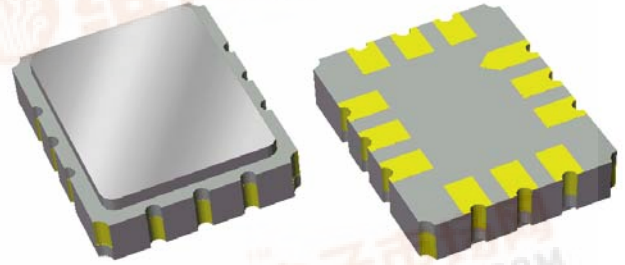

#### Package

Surface Mount 7.01 x 5.51 x 1.63 mm

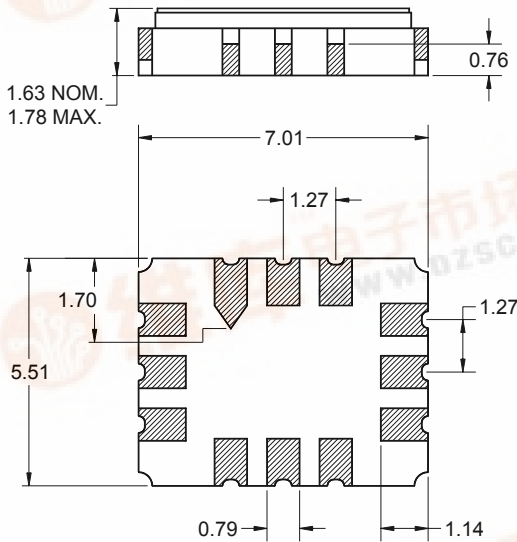

#### Pin Configuration

Bottom View

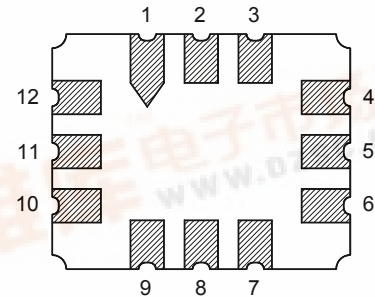

Pin No.	Description
3	Input
4	Input return
9	Output
10	Output return
1,2,5,6	Case ground
7,8,11,12	Case ground

Dimensions shown are nominal in millimeters  
 All tolerances are  $\pm 0.15$ mm except overall  
 length and width  $+0.13$ mm/ $-0.13$ mm

Body:  $Al_2O_3$  ceramic

Lid: Kovar, Ni plated

Terminations: Au plating 0.5 - 1.0 $\mu$ m,  
 over a 2 - 6 $\mu$ m Ni plating



# Preliminary Data Sheet

## Electrical Specifications <sup>(1)</sup>

Operating Temperature Range: <sup>(2)</sup> -10 to +60 °C

Parameter <sup>(3)</sup>	Minimum	Typical	Maximum	Unit
Center Frequency	-	325	-	MHz
Minimum Insertion Loss	-	9.6	14	dB
Lower 3 dB Bandedge <sup>(4)</sup>	-	318.99	320	MHz
Upper 3 dB Bandedge	330	332.02	-	MHz
Lower 40 dB Bandedge <sup>(4)</sup>	307.5	315.4	-	MHz
Upper 40 dB Bandedge	-	339.1	342.5	MHz
Amplitude Ripple	-	0.6	1.0	dB
Phase Linearity	-	9	-	deg
Group Delay Variation	-	48	75	nsec
Relative Attenuation <sup>(4)</sup>				
10 - 220 MHz	50	55	-	dB
220 - 300 MHz	45	50	-	dB
350 - 355 MHz	40	45	-	dB
355 - 375 MHz	35	40	-	dB
375 - 380 MHz	40	45	-	dB
380 - 405 MHz	35	40	-	dB
405 - 500 MHz	40	45	-	dB
Source Impedance: <sup>(5)</sup>	-	50	-	Ω
Load Impedance: <sup>(5)</sup>	-	50	-	Ω
Substrate Material	-	YZ LiNbO <sub>3</sub>	-	-

### Notes:

1. All specifications are based on the test circuit shown below
2. In production, devices will be tested at room temperature to a guardbanded specification to ensure electrical compliance over temperature
3. Electrical margin has been built into the design to account for the variations due to temperature drift and manufacturing tolerances
4. All attenuation measurements are measured relative to minimum insertion loss
5. This is the optimum impedance in order to achieve the performance shown

### Test Circuit:

Actual matching values may vary due to PCB layout and parasitics

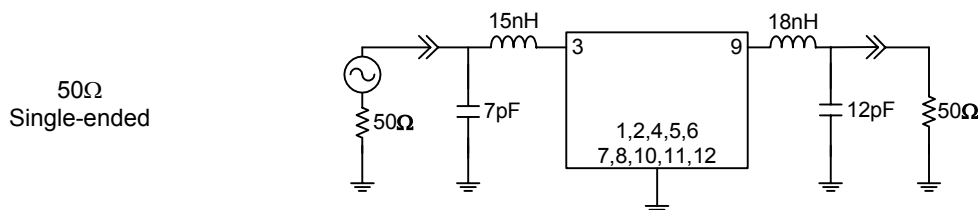

**Preliminary Data Sheet**

**Typical Performance (at +25°C)**

**Frequency Response**

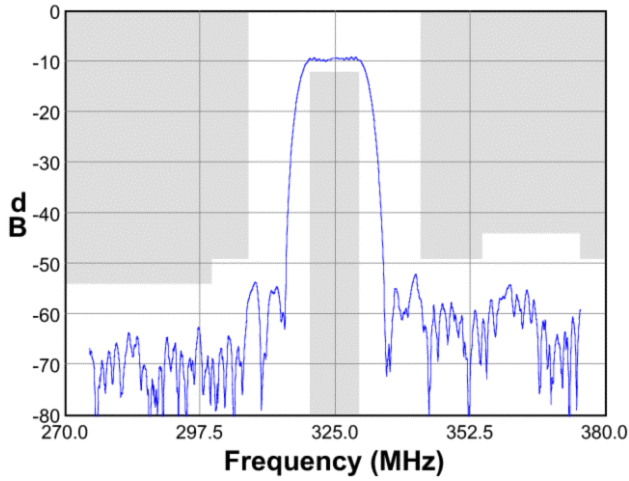

**Passband Response**

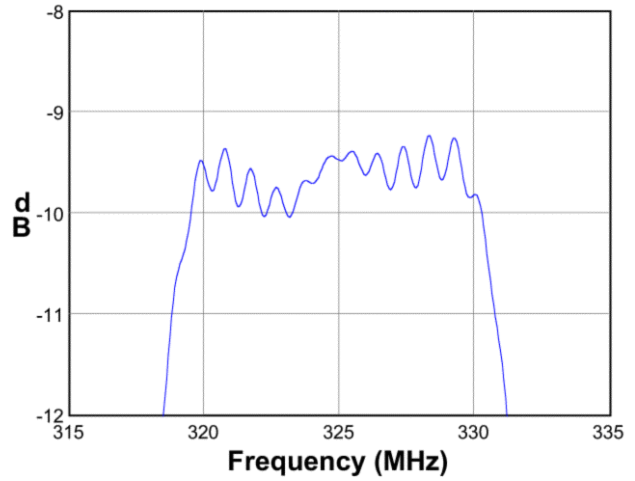

**Wideband Response**

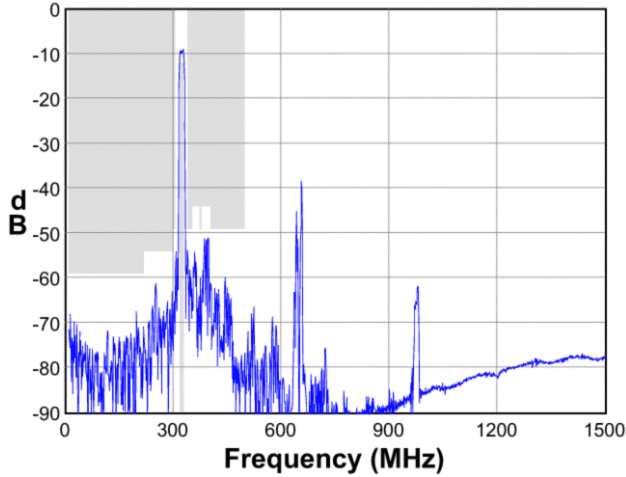

**Group Delay Variation**

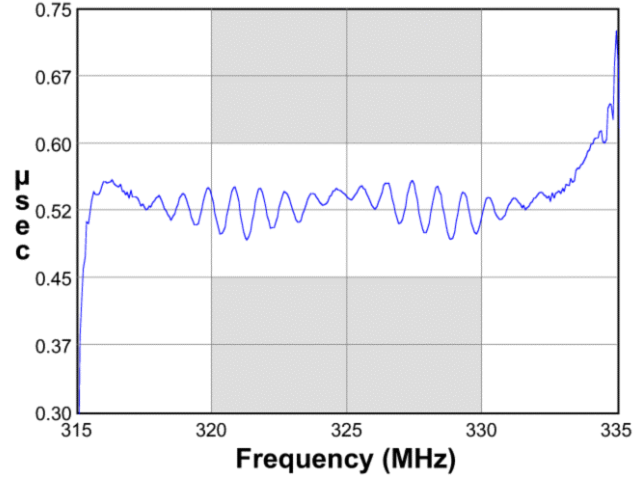

**Input Smith Chart**

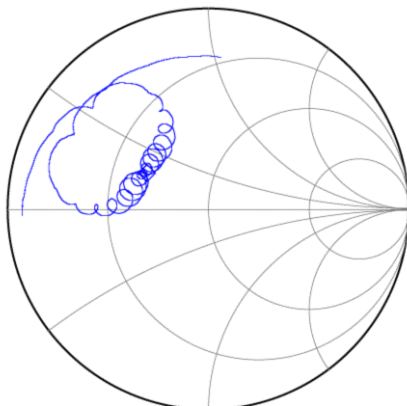

**Output Smith Chart**

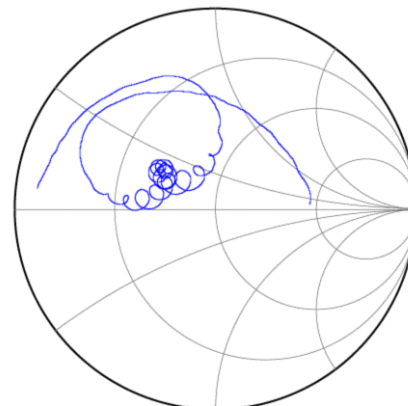

**Preliminary Data Sheet**

**Matching Schematics**

Actual matching values may vary due to PCB layout and parasitics

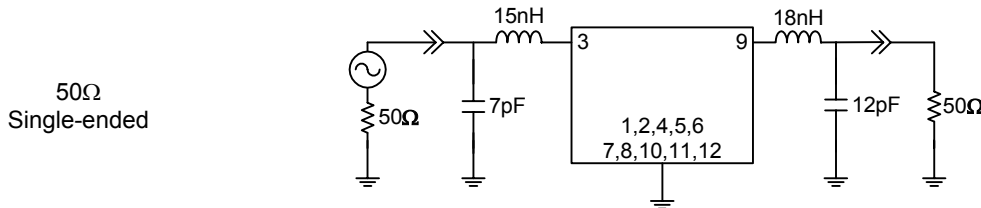

**Marking**

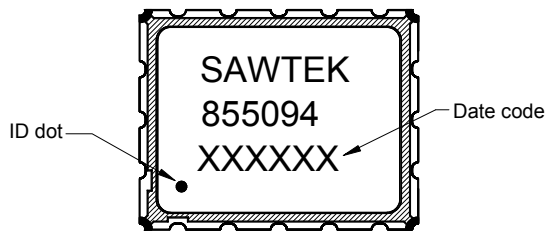

The date code consists of: day of the current year (Julian, 3 digits), last digit of the year (1 digit) and hour (2 digits)

**PCB Footprint**

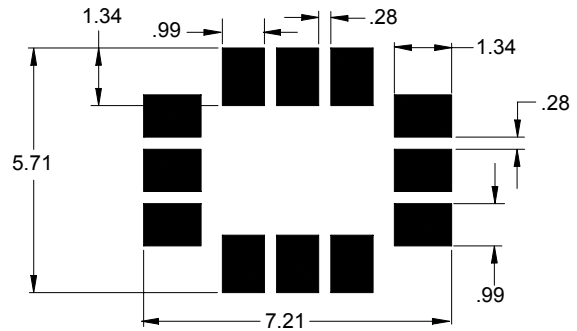

This footprint represents a recommendation only  
Dimensions shown are nominal in millimeters

**Tape and Reel**

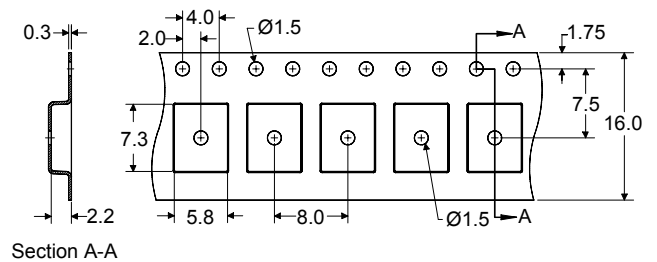
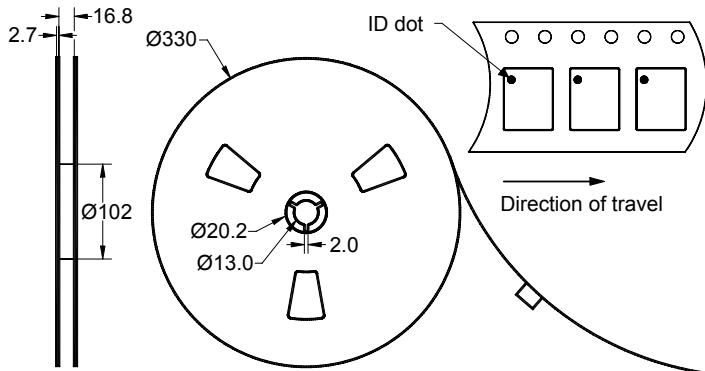

Dimensions shown are nominal in millimeters  
Packaging quantity: 3000 units/reel

# Preliminary Data Sheet

## Maximum Ratings

Parameter	Symbol	Minimum	Typical	Maximum	Unit
Operating Temperature Range	T	-10	+25	+60	°C
Storage Temperature Range	T <sub>stg</sub>	-40	-	+85	°C

### Warnings

- Electrostatic Sensitive Device (ESD) 
- Avoid ultrasonic exposure

## Links to Additional Technical Information

[PCB Layout Tips](#)

[Qualification Flowchart](#)

[Soldering Profile](#)

[S-Parameters](#)

[Other Technical Information](#)

Sawtek's liability is limited only to the Surface Acoustic Wave (SAW) component(s) described in this data sheet. Sawtek does not accept any liability for applications, processes, circuits or assemblies which are implemented using any Sawtek component described in this data sheet.

## Contact Information



PO Box 609501  
 Orlando, FL 32860-9501  
 USA

Phone: +1 (407) 886-8860  
 Fax: +1 (407) 886-7061  
 Email: [custservice@sawtek.com](mailto:custservice@sawtek.com)  
 Web: [www.sawtek.com](http://www.sawtek.com)

Or contact one of our worldwide network of [sales offices](#), [representatives](#) or [distributors](#)