

EVERLIGHT EVERLIGHT ELECTRONICS CO.,LTD.

Technical Data Sheet

High performance SMD LED with Reflector

96-22SUGC/S400-A4

Features

- White package.
- Dual-chip, wide-angle, low-profile LEDs .
- Excellent chip to chip consistency
- Super Intensity
- Highperformance
- Pb-free.
- The product itself will remain within RoHS compliant version.



Applications

- Automotive: backlighting in dashboard and switch.
- Telecommunication: indicator and backlighting in telephone and fax.
- Indicator and backlight for audio and video equipment.
- Indicator and backlight for battery driven equipment.
- Display Screen Illumination on Portable Handheld Devices
- Indicator and backlight in office equipment.
- General use.

Device Selection Guide

Chip		Lens Color
Material	Emitted Color	
InGaN	Brilliant Green	Water Clear



Package Dimensions

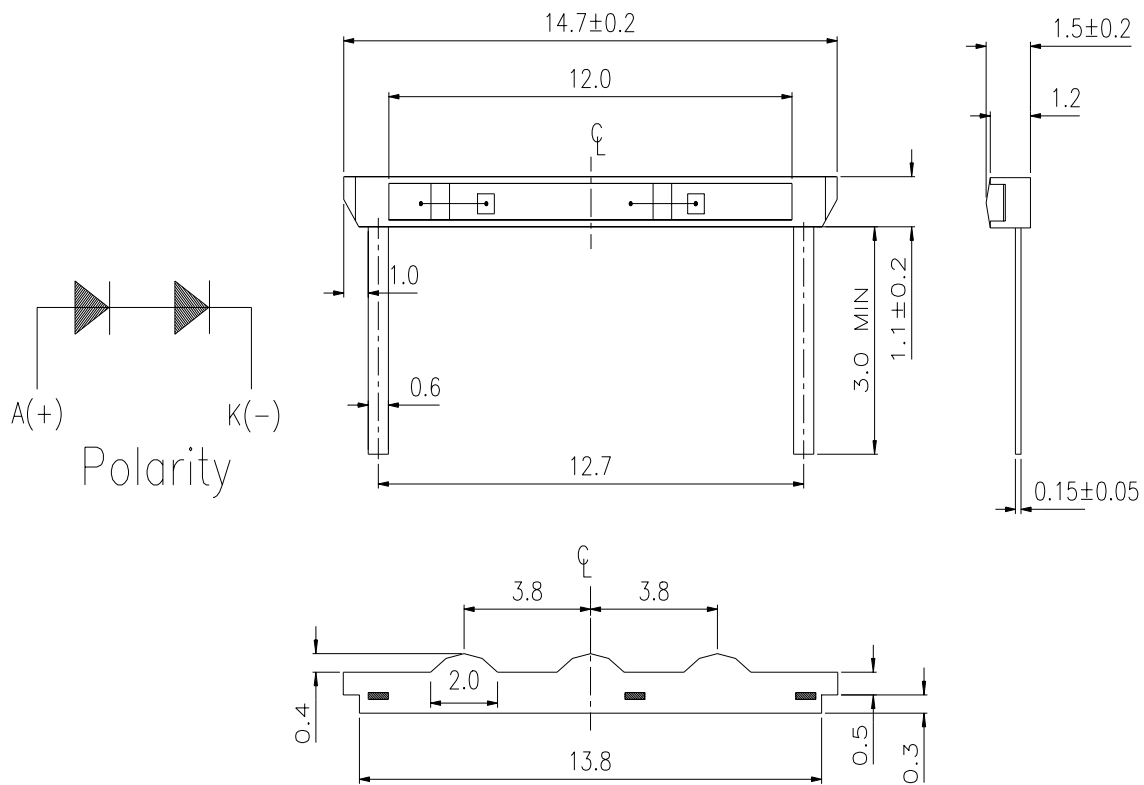

Note: The tolerances unless mentioned is ± 0.1 mm ;Unit = mm

Absolute Maximum Ratings (Ta=25°C)

Parameter	Symbol	Rating	Unit
Reverse Voltage	V _R	5	V
Forward Current	I _F	25	mA
Operating Temperature	T _{opr}	-40 ~ +85	°C
Storage Temperature	T _{stg}	-40~ +100	°C
Electrostatic Discharge(HBM)	ESD	150	V
Power Dissipation	P _d	110	mW
Peak Forward Current(Duty 1/10 @ 1KHz)	I _{FP}	100	mA
Soldering Temperature	T _{sol}	Reflow Soldering : 260 °C for 10 sec. Hand Soldering : 350 °C for 3 sec.	

Electro-Optical Characteristics (Ta=25°C)

Parameter	Symbol	Min.	Typ.	Max.	Unit	Condition
Luminous Intensity	I _v	120	140	-----	mcd	I _F =20mA
Viewing Angle	2θ 1/2	-----	145	-----	deg	I _F =20mA
Peak Wavelength	λ _p	-----	518	-----	nm	I _F =20mA
Dominant Wavelength	λ _d	-----	525	-----	nm	I _F =20mA
Spectrum Radiation Bandwidth	Δλ	-----	35	-----	nm	I _F =20mA
Forward Voltage	V _F	-----	6.6	7.4	V	I _F =20mA
Reverse Current	I _R	-----	-----	10	uA	V _R =5V

Typical Electro-Optical Characteristics Curves

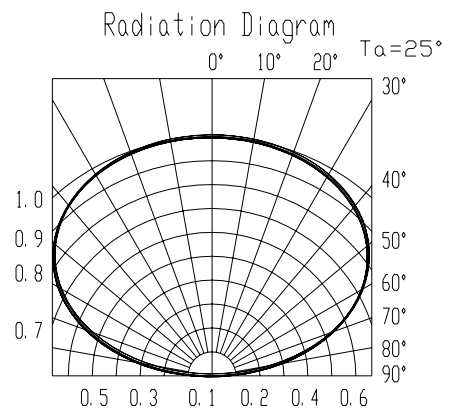
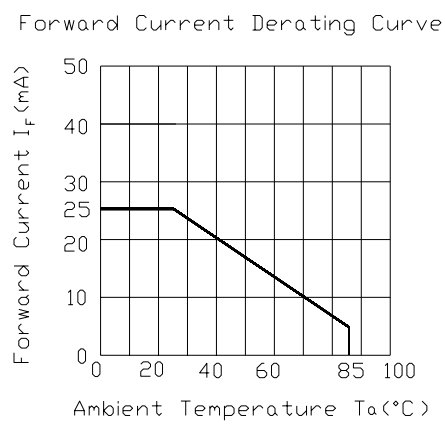
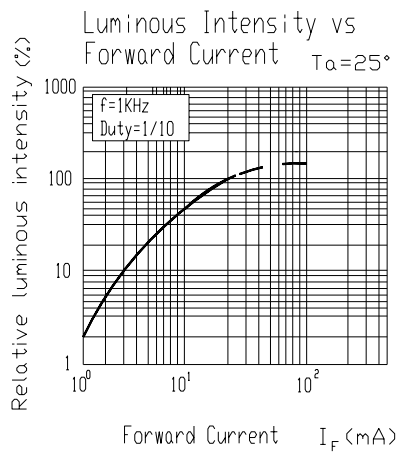
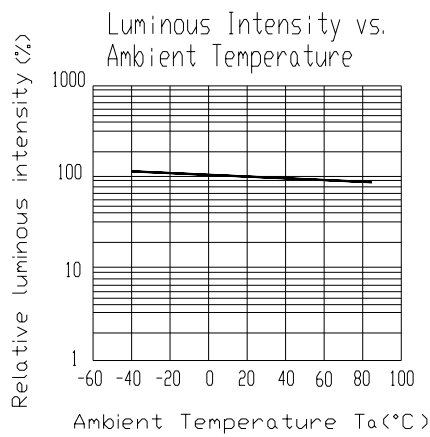
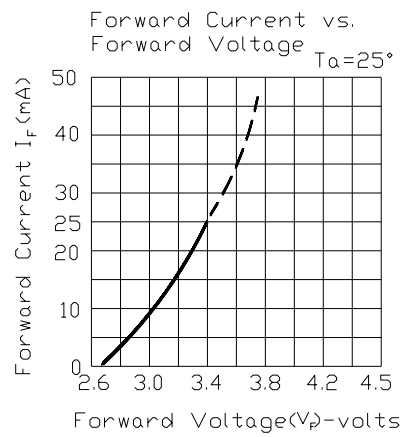
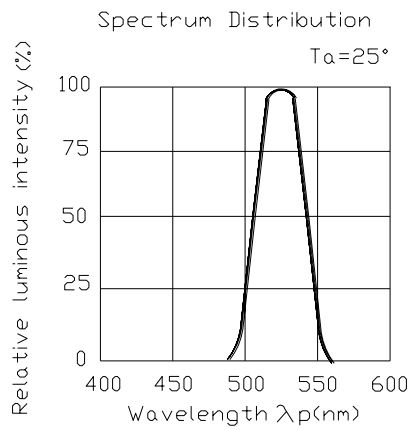



96-22SUGC/S400-A4

Label explanation

CAT: Luminous Intensity Rank

HUE: Dom. Wavelength Rank

REF: Forward Voltage Rank

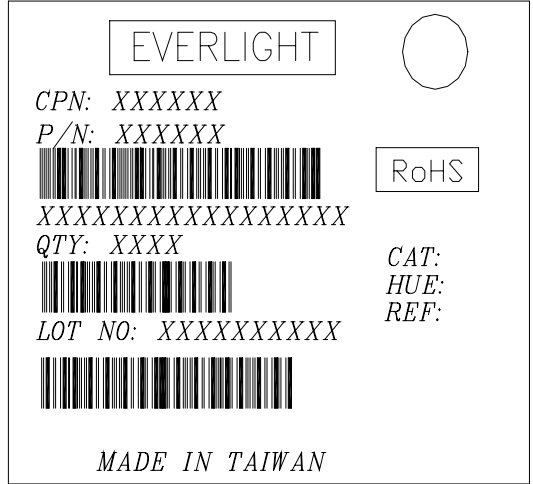

Reliability Test Items And Conditions

The reliability of products shall be satisfied with items listed below.

Confidence level : 90%

LTPD : 10%

No.	Items	Test Condition	Test Hours/Cycles	Sample Size	Ac/Re
1	Soldering Heat	Temp. : 260°C ±5°C	10 Sec	22 PCS.	0/1
2	Temperature Cycle	H : +100°C 15min ∫ 5 min L : -40°C 15min	300 Cycles	22 PCS.	0/1
3	Thermal Shock	H : +100°C 5min ∫ 10 sec L : -10°C 5min	300 Cycles	22 PCS.	0/1
4	High Temperature Storage	Temp. : 100°C	1000 Hrs.	22 PCS.	0/1
5	Low Temperature Storage	Temp. : -40°C	1000 Hrs.	22 PCS.	0/1
6	DC Operating Life	If = 20 mA / 25°C	1000 Hrs.	22 PCS.	0/1
7	High Temperature / High Humidity	85°C/85%RH	1000 Hrs.	22 PCS.	0/1



Precautions For Use

1. Over-current-proof

Customer must apply resistors for protection, otherwise slight voltage shift will cause big current change (Burn out will happen).

2. Storage

2.1 Do not open moisture proof bag before the products are ready to use.

2.2 Before opening the package: The LEDs should be kept at 30°C or less and 90%RH or less.

2.3 After opening the package: The LED's floor life is 1 year under 30 deg C or less and 60% RH or less.

If unused LEDs remain, it should be stored in moisture proof packages.

2.4 If the moisture absorbent material (silica gel) has faded away or the LEDs have exceeded the storage time, baking treatment should be performed using the following conditions.

Baking treatment : 60±5°C for 24 hours.

3.Soldering Iron

Each terminal is to go to the tip of soldering iron temperature less than 350°C for 3 seconds within once in less than the soldering iron capacity 25W. Leave two seconds and more intervals, and do soldering of each terminal. Be careful because the damage of the product is often started at the time of the hand solder.

EVERLIGHT ELECTRONICS CO., LTD.

Office: No 25, Lane 76, Sec 3, Chung Yang Rd,
Tucheng, Taipei 236, Taiwan, R.O.C

Tel: 886-2-2267-2000, 2267-9936

Fax: 886-2267-6244, 2267-6189, 2267-6306
<http://www.everlight.com>