



Isolated DC-to-DC Converter

ADuM5000

FEATURES

- isoPower, integrated isolated dc-to-dc converter**
- Regulated 3.3 V or 5 V output**
- Up to 500 mW output power**
- 16-lead SOIC package with >8 mm creepage**
- High temperature operation: 105°C maximum**
- High common-mode transient immunity: >25 kV/μs**
- Thermal overload protection**
- Safety and regulatory approvals**
 - UL recognition
 - 2500 V rms for 1 minute per UL 1577
 - CSA Component Acceptance Notice #5A (pending)
 - VDE certificate of conformity (pending)
 - DIN V VDE V 0884-10 (VDE V 0884-10):2006-12
 - $V_{IORM} = 560 \text{ V peak}$

APPLICATIONS

- RS-232/RS-422/RS-485 transceivers
- Industrial field bus isolation
- Power supply startups and gate drives
- Isolated sensor interfaces
- Industrial PLCs

GENERAL DESCRIPTION

The ADuM5000¹ is an isolated dc-to-dc converter based on the Analog Devices, Inc., iCoupler® technology. The dc-to-dc converter in this device provides regulated, isolated power in several combinations of input and output voltage as listed in Table 1.

The Analog Devices chip-scale transformer iCoupler technology transfers isolated power in this dc-to-dc converter with up to 33% efficiency. The result is a small form factor, total isolation solution.

Higher output power levels are obtained by using the ADuM5000 to augment the power output of ADuM5401, ADuM5402, ADuM5403, ADuM5404, and ADuM520x iCouplers with isoPower®.

FUNCTIONAL BLOCK DIAGRAM

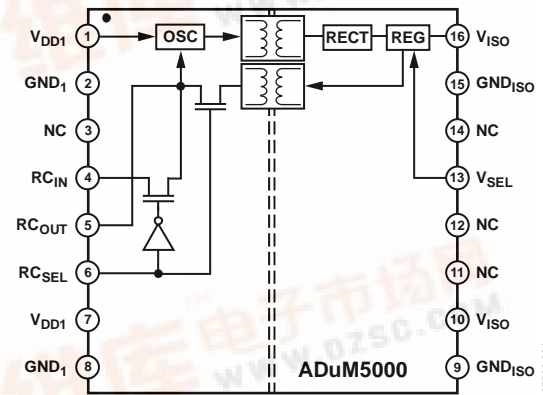

Figure 1.

isoPower uses high frequency switching elements to transfer power through its transformer. Special care must be taken during printed circuit board (PCB) layout to meet emissions standards. Refer to the AN-0971 application note for board layout recommendations.

Table 1.

Input Voltage	Output Voltage	Output Power
5 V	5 V	500 mW
5 V	3.3 V	330 mW
3.3 V	3.3 V	200 mW

¹ Protected by U.S. Patents 5,952,849; 6,873,065; 6,903,578; and 7,075,329; other patents pending.



ADuM5000

TABLE OF CONTENTS

Features	1	Recommended Operating Conditions	7
Applications.....	1	Absolute Maximum Ratings	8
Functional Block Diagram	1	ESD Caution.....	8
General Description	1	Pin Configuration and Function Descriptions.....	9
Revision History	2	Typical Performance Characteristics	10
Specifications.....	3	Applications Information	12
Electrical Characteristics—5 V Primary Input Supply/5 V Secondary Isolated Supply	3	PCB Layout	12
Electrical Characteristics—3.3 V Primary Input Supply/3.3 V Secondary Isolated Supply	3	EMI Considerations.....	12
Electrical Characteristics—5 V Primary Input Supply/3.3 V Secondary Isolated Supply	4	Thermal Analysis	12
Package Characteristics	5	Current Limit and Thermal Overload Protection	13
Regulatory Information.....	5	Power Considerations.....	13
Insulation and Safety-Related Specifications.....	5	Increasing Available Power	13
DIN V VDE V 0884-10 (VDE V 0884-10) Insulation Characteristics	6	Insulation Lifetime	14
		Outline Dimensions	15
		Ordering Guide	15

REVISION HISTORY

10/08—Revision 0: Original Version

SPECIFICATIONS

ELECTRICAL CHARACTERISTICS—5 V PRIMARY INPUT SUPPLY/5 V SECONDARY ISOLATED SUPPLY

$4.5\text{ V} \leq V_{DD1} \leq 5.5\text{ V}$, $V_{SEL} = V_{ISO}$; each voltage is relative to its respective ground. All minimum/maximum specifications apply over the entire recommended operating range, unless otherwise noted. All typical specifications are at $T_A = 25^\circ\text{C}$, $V_{DD} = 5.0\text{ V}$, $V_{ISO} = 5.0\text{ V}$, and $V_{SEL} = V_{ISO}$.

Table 2.

Parameter	Symbol	Min	Typ	Max	Unit	Test Conditions
DC-to-DC CONVERTER POWER SUPPLY						
Setpoint	V_{ISO}	4.7	5.0	5.4	V	$I_{ISO} = 0\text{ mA}$
Line Regulation	$V_{ISO(LINE)}$		1		mV/V	$I_{ISO} = 50\text{ mA}$, $V_{DD1} = 4.5\text{ V to }5.5\text{ V}$
Load Regulation	$V_{ISO(LOAD)}$		1	5	%	$I_{ISO} = 10\text{ mA to }90\text{ mA}$
Output Ripple	$V_{ISO(RIP)}$		75		mV p-p	20 MHz bandwidth, $C_{BO} = 0.1\text{ }\mu\text{F} 10\text{ }\mu\text{F}$, $I_{ISO} = 90\text{ mA}$
Output Noise	$V_{ISO(N)}$		200		mV p-p	$C_{BO} = 0.1\text{ }\mu\text{F} 10\text{ }\mu\text{F}$, $I_{ISO} = 90\text{ mA}$
Switching Frequency	f_{OSC}		180		MHz	
PWM Frequency	f_{PWM}		625		kHz	
I_{DD1} Supply Current, Full V_{ISO} Load	$I_{DD1(MAX)}$		290		mA	$I_{ISO} = 100\text{ mA}$
Maximum Output Supply Current	$I_{ISO(MAX)}$	100			mA	$V_{ISO} > 4.5\text{ V}$
Efficiency At Maximum Output Supply Current			34		%	$I_{ISO} = 100\text{ mA}$
I_{DD1} Supply Current, No V_{ISO} Load	$I_{DD1(Q)}$		4	15	mA	$I_{ISO} = 0\text{ mA}$
Undervoltage Lockout, V_{DD1} and V_{ISO} Supply						
Positive Going Threshold	V_{UV+}		2.7		V	
Negative Going Threshold	V_{UV-}		2.4		V	
Hysteresis	V_{UVH}		0.3		V	

ELECTRICAL CHARACTERISTICS—3.3 V PRIMARY INPUT SUPPLY/3.3 V SECONDARY ISOLATED SUPPLY

$3.0\text{ V} \leq V_{DD1} \leq 3.6\text{ V}$, $V_{SEL} = \text{GND}_{ISO}$; each voltage is relative to its respective ground. All minimum/maximum specifications apply over the entire recommended operating range, unless otherwise noted. All typical specifications are at $T_A = 25^\circ\text{C}$, $V_{DD} = 3.3\text{ V}$, $V_{ISO} = 3.3\text{ V}$, and $V_{SEL} = \text{GND}_{ISO}$.

Table 3.

Parameter	Symbol	Min	Typ	Max	Unit	Test Conditions
DC-to-DC CONVERTER POWER SUPPLY						
Setpoint	V_{ISO}	3.0	3.3	3.6	V	$I_{ISO} = 0\text{ mA}$
Line Regulation	$V_{ISO(LINE)}$		1		mV/V	$I_{ISO} = 30\text{ mA}$, $V_{DD1} = 3.0\text{ V to }3.6\text{ V}$
Load Regulation	$V_{ISO(LOAD)}$		1	5	%	$I_{ISO} = 6\text{ mA to }54\text{ mA}$
Output Ripple	$V_{ISO(RIP)}$		50		mV p-p	20 MHz bandwidth, $C_{BO} = 0.1\text{ }\mu\text{F} 10\text{ }\mu\text{F}$, $I_{ISO} = 54\text{ mA}$
Output Noise	$V_{ISO(N)}$		130		mV p-p	$C_{BO} = 0.1\text{ }\mu\text{F} 10\text{ }\mu\text{F}$, $I_{ISO} = 54\text{ mA}$
Switching Frequency	f_{OSC}		180		MHz	
PWM Frequency	f_{PWM}		625		kHz	
I_{DD1} Supply Current, Full V_{ISO} Load	$I_{DD1(MAX)}$		175		mA	$I_{ISO} = 60\text{ mA}$
Maximum Output Supply Current	$I_{ISO(MAX)}$	60			mA	$V_{ISO} > 3.0\text{ V}$
Efficiency At Maximum Output Supply Current			35		%	$I_{ISO} = 60\text{ mA}$
I_{DD1} Supply Current, No V_{ISO} Load	$I_{DD1(Q)}$		3	12	mA	$I_{ISO} = 0\text{ mA}$
Undervoltage Lockout, V_{DD1} and V_{ISO} Supply						
Positive Going Threshold	V_{UV+}		2.7		V	
Negative Going Threshold	V_{UV-}		2.4		V	
Hysteresis	V_{UVH}		0.3		V	

ADuM5000

ELECTRICAL CHARACTERISTICS—5 V PRIMARY INPUT SUPPLY/3.3 V SECONDARY ISOLATED SUPPLY

4.5 V \leq $V_{DD1} \leq$ 5.5 V, $V_{SEL} = GND_{ISO}$, each voltage is relative to its respective ground. All minimum/maximum specifications apply over the entire recommended operating range, unless otherwise noted. All typical specifications are at $T_A = 25^\circ\text{C}$, $V_{DD} = 5.0$ V, $V_{ISO} = 3.3$ V, and $V_{SEL} = GND_{ISO}$.

Table 4.

Parameter	Symbol	Min	Typ	Max	Unit	Test Conditions
DC-to-DC CONVERTER POWER SUPPLY						
Setpoint	V_{ISO}	3.0	3.3	3.6	V	$I_{ISO} = 0$ mA
Line Regulation	$V_{ISO(LINE)}$		1		mV/V	$I_{ISO} = 50$ mA, $V_{DD1} = 4.5$ V to 5.5 V
Load Regulation	$V_{ISO(LOAD)}$		1	5	%	$I_{ISO} = 10$ mA to 100 mA
Output Ripple	$V_{ISO(RIP)}$		50		mV p-p	20 MHz bandwidth, $C_{BO} = 0.1 \mu\text{F} 10 \mu\text{F}$, $I_{ISO} = 90$ mA
Output Noise	$V_{ISO(N)}$		130		mV p-p	$C_{BO} = 0.1 \mu\text{F} 10 \mu\text{F}$, $I_{ISO} = 90$ mA
Switching Frequency	f_{OSC}		180		MHz	
PWM Frequency	f_{PWM}		625		kHz	
I_{DD1} Supply Current, Full V_{ISO} Load	$I_{DD1(MAX)}$		250		mA	$I_{ISO} = 100$ mA
Maximum Output Supply Current	$I_{ISO(MAX)}$	100			mA	$V_{ISO} > 3.0$ V
Efficiency At Maximum Output Supply Current			28		%	$I_{ISO} = 100$ mA
I_{DD1} Supply Current, No V_{ISO} Load	$I_{DD1(Q)}$		3	12	mA	$I_{ISO} = 0$ mA
Undervoltage Lockout, V_{DD1} and V_{ISO} Supply						
Positive Going Threshold	V_{UV+}		2.7		V	
Negative Going Threshold	V_{UV-}		2.4		V	
Hysteresis	V_{UVH}		0.3		V	

PACKAGE CHARACTERISTICS

Table 5.

Parameter	Symbol	Min	Typ	Max	Unit	Test Conditions
RESISTANCE AND CAPACITANCE						
Resistance (Input-to-Output) ¹	R _{I-O}		10 ¹²		Ω	f = 1 MHz Thermocouple is located at the center of the package underside; test conducted on a 4-layer board with thin traces ³
Capacitance (Input-to-Output) ¹	C _{I-O}		2.2		pF	
Input Capacitance ²	C _I		4.0		pF	
IC Junction-to-Ambient Thermal Resistance	θ _{JA}		45		°C/W	
THERMAL SHUTDOWN						
Thermal Shutdown Threshold	T _{SD}		150		°C	T _J rising
Thermal Shutdown Hysteresis	T _{SD-HYS}		20		°C	

¹ This device is considered a 2-terminal device; Pin 1 through Pin 8 are shorted together, and Pin 9 through Pin 16 are shorted together.

² Input capacitance is from any input data pin to ground.

³ Refer to the Power Considerations section for thermal model definitions.

REGULATORY INFORMATION

The ADuM5000 is approved by the organizations listed in Table 6. Refer to Table 11 and the Insulation Lifetime section for details regarding recommended maximum working voltages for specific cross isolation waveforms and insulation levels.

Table 6.

UL	CSA (Pending)	VDE (Pending)
Recognized under 1577 component recognition program ¹	Approved under CSA Component Acceptance Notice #5A	Certified according to DIN V VDE V 0884-10 (VDE V 0884-10):2006-12 ²
Single insulation, 2500 V rms isolation voltage	Reinforced insulation per CSA 60950-1-03 and IEC 60950-1, 400 V rms (566 V peak) maximum working voltage	Reinforced insulation, 560 V peak
File E214100	File 205078	File 2471900-4880-0001

¹ In accordance with UL 1577, each ADuM5000 is proof tested by applying an insulation test voltage ≥ 3000 V rms for 1 sec (current leakage detection limit = 5 μA).

² In accordance with DIN V VDE V 0884-10, each ADuM5000 is proof tested by applying an insulation test voltage ≥ 1050 V peak for 1 sec (partial discharge detection limit = 5 pC). The * marking branded on the component designates DIN V VDE V 0884-10 approval.

INSULATION AND SAFETY-RELATED SPECIFICATIONS

Table 7.

Parameter	Symbol	Value	Unit	Conditions
Rated Dielectric Insulation Voltage		2500	V rms	1-minute duration
Minimum External Air Gap (Clearance)	L(I01)	>8 min	mm	Measured from input terminals to output terminals, shortest distance through air
Minimum External Tracking (Creepage)	L(I02)	>8 min	mm	Measured from input terminals to output terminals, shortest distance path along body
Minimum Internal Gap (Internal Clearance)		0.017 min	mm	Distance through the insulation
Tracking Resistance (Comparative Tracking Index)	CTI	>175	V	DIN IEC 112/VDE 0303 Part 1
Isolation Group		IIIa		Material Group (DIN VDE 0110, 1/89, Table 1)

ADuM5000

DIN V VDE V 0884-10 (VDE V 0884-10) INSULATION CHARACTERISTICS

This power module is suitable for reinforced electrical isolation only within the safety limit data. Maintenance of the safety data is ensured by protective circuits. The * marking on packages denotes DIN V VDE V 0884-10 approval.

Table 8.

Description	Conditions	Symbol	Characteristic	Unit
Installation Classification per DIN VDE 0110 For Rated Mains Voltage ≤ 150 V rms For Rated Mains Voltage ≤ 300 V rms For Rated Mains Voltage ≤ 400 V rms			I to IV I to III I to II	
Climatic Classification			40/105/21	
Pollution Degree per DIN VDE 0110, Table 1			2	
Maximum Working Insulation Voltage		V_{IORM}	560	V peak
Input-to-Output Test Voltage Method b1	$V_{IORM} \times 1.875 = V_{PR}$, 100% production test, $t_m = 1$ sec, partial discharge < 5 pC	V_{PR}	1050	V peak
Method a	$V_{IORM} \times 1.6 = V_{PR}$, $t_m = 60$ sec, partial discharge < 5 pC	V_{PR}	896	V peak
After Environmental Tests Subgroup 1			672	V peak
After Input and/or Safety Test Subgroup 2 and Subgroup 3	$V_{IORM} \times 1.2 = V_{PR}$, $t_m = 60$ sec, partial discharge < 5 pC			
Highest Allowable Overvoltage	Transient overvoltage, $t_{TR} = 10$ sec	V_{TR}	4000	V peak
Safety-Limiting Values	Maximum value allowed in the event of a failure (see Figure 2)			
Case Temperature		T_s	150	°C
Side 1 I_{DD1} Current		I_{S1}	555	mA
Insulation Resistance at T_s	$V_{IO} = 500$ V	R_s	>10 ⁹	Ω

Thermal Derating Curve

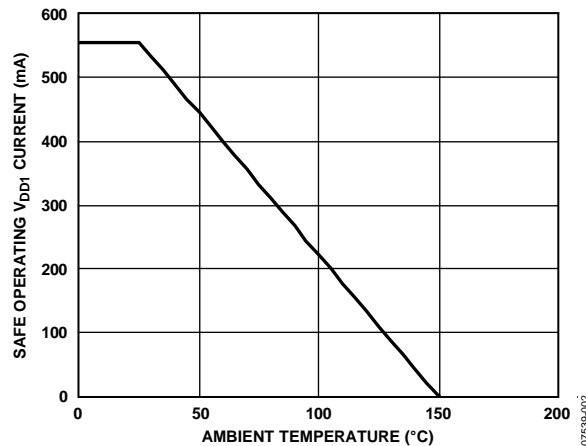

Figure 2. Thermal Derating Curve, Dependence of Safety Limiting Values on Case Temperature, per DIN EN 60747-5-2

RECOMMENDED OPERATING CONDITIONS

Table 9.

Parameter	Symbol	Min	Max	Unit	Comments
TEMPERATURE					
Operating Temperature	T_A	-40	+105	°C	
SUPPLY VOLTAGES					Each voltage is relative to its respective ground
V_{DD} @ $V_{SEL} = 0\text{ V}$	V_{DD}	2.7	5.5	V	
V_{DD} @ $V_{SEL} = 5\text{ V}$	V_{DD}	4.5	5.5	V	
MINIMUM POWER ON SLEW RATE	V_{SLEW}	150		V/ms	

ADuM5000

ABSOLUTE MAXIMUM RATINGS

Ambient temperature = 25°C, unless otherwise noted.

Table 10.

Parameter	Rating
Storage Temperature (T _{ST})	−55°C to +150°C
Ambient Operating Temperature (T _A)	−40°C to +105°C
Supply Voltages (V _{DD} , V _{ISO}) ¹	−0.5 V to +7.0 V
Input Voltage (CTR, RC _{IN} , V _{SEL}) ^{1,2}	−0.5 V to V _{DDI} + 0.5 V
Output Voltage (RC _{OUT}) ^{1,2}	−0.5 V to V _{DDO} + 0.5 V
Average Total Output Current ³ I _{ISO}	100 mA
Common-Mode Transients ⁴	−100 kV/μs to +100 kV/μs

¹ Each voltage is relative to its respective ground.

² V_{DDI} and V_{DDO} refer to the supply voltages on the input and output sides of a given channel, respectively. See the PCB Layout section.

³ See Figure 2 for maximum rated current values for various temperatures.

⁴ Refers to common-mode transients across the insulation barrier. Common-mode transients exceeding the absolute maximum ratings may cause latch-up or permanent damage.

Stresses above those listed under Absolute Maximum Ratings may cause permanent damage to the device. This is a stress rating only; functional operation of the device at these or any other conditions above those indicated in the operational section of this specification is not implied. Exposure to absolute maximum rating conditions for extended periods may affect device reliability.

Table 11. Maximum Continuous Working Voltage¹

Parameter	Max	Unit	Reference Standard
AC Voltage			
Bipolar Waveform	424	V peak	50-year minimum lifetime
Unipolar Waveform			
Basic Insulation	600	V peak	Maximum approved working voltage per IEC 60950-1
Reinforced Insulation	560	V peak	Maximum approved working voltage per IEC 60950-1 and VDE V 0884-10
DC Voltage			
Basic Insulation	600	V peak	Maximum approved working voltage per IEC 60950-1
Reinforced Insulation	560	V peak	Maximum approved working voltage per IEC 60950-1 and VDE V 0884-10

¹ Refers to continuous voltage magnitude imposed across the isolation barrier. See the Insulation Lifetime section for more details.

ESD CAUTION



ESD (electrostatic discharge) sensitive device. Charged devices and circuit boards can discharge without detection. Although this product features patented or proprietary protection circuitry, damage may occur on devices subjected to high energy ESD. Therefore, proper ESD precautions should be taken to avoid performance degradation or loss of functionality.

PIN CONFIGURATION AND FUNCTION DESCRIPTIONS

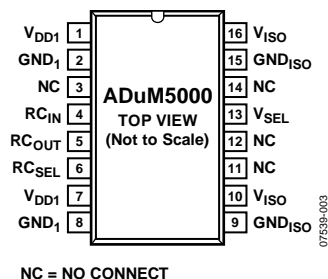

NC = NO CONNECT

Figure 3. Pin Configuration

Table 12. Pin Function Descriptions

Pin No.	Mnemonic	Description
1, 7	V _{DD1}	Primary Supply Voltage 3.0 V to 5.5 V. Pin 1 and Pin 7 are internally connected to each other, and it is recommended that both pins be externally connected to a common power source.
2, 8	GND ₁	Ground 1. Ground reference for the primary side of the converter. Pin 2 and Pin 8 are internally connected to each other, and it is recommended that both pins be connected to a common ground.
3, 11, 12, 14	NC	No Internal Connection.
4	RC _{IN}	Regulation Control Input. In slave power configuration (RC _{SEL} = low), this pin is connected to the RC _{OUT} of a master <i>isoPower</i> device, or tied low to disable the converter. In master/standalone mode (RC _{SEL} = high) this pin has no function. This pin is weakly pulled to low. In noisy environments, it should be tied to low or to a PWM control source. Note: This pin must not be tied high if RC _{SEL} is low; this combination causes excessive voltage on the secondary side of the converter, damaging the ADuM5000 and possibly the devices that it powers.
5	RC _{OUT}	Regulation Control Output. In master power configuration, this pin is connected to the RC _{IN} of a slave <i>isoPower</i> device to allow the ADuM5000 to regulate additional devices.
6	RC _{SEL}	Control Input. Sets either self-regulation/master mode (RC _{SEL} high) or slave mode (RC _{SEL} low). This pin is weakly pulled to the high state. In noisy environments, tie this pin either high or low.
9, 15	GND _{ISO}	Ground Reference for the Secondary Side of the Converter. Pin 9 and Pin 15 are internally connected to each other, and it is recommended that both pins be connected to a common ground.
10, 16	V _{ISO}	Secondary Supply Voltage Output External Loads, 3.3 V (V _{SEL} low) or 5.0 V (V _{SEL} high). 5.0 V output functionality is not guaranteed for a 3.3 V primary supply input. Pin 10 and Pin 16 are internally connected to each other, and connecting both to GND _{ISO} is recommended.
13	V _{SEL}	Output Voltage Selection. When V _{SEL} = V _{ISO} , the V _{ISO} set point is 5.0 V. When V _{SEL} = GND _{ISO} , the V _{ISO} set point is 3.3 V. This pin is weakly pulled to high. In noisy environments, tie this pin either high or low. In slave regulation mode, this pin has no function.

Table 13. Truth Table (Positive Logic)

RC _{SEL} Input	RC _{IN} Input	RC _{OUT} Output	V _{SEL} Input	V _{DD1} Input	V _{ISO} Output	Operation
H	X	PWM ¹	H	5.0 V	5.0 V	Master mode operation, self regulating.
H	X	PWM ¹	L	5.0 V	3.3 V	Master mode operation, self regulating.
H	X	PWM ¹	H	3.3 V	5.0 V	This configuration is not recommended.
H	X	PWM ¹	L	3.3 V	3.3 V	Master mode operation, self regulating.
L	PWM ¹	RC _{IN}	X	X	X	Slave mode operation, regulation from another <i>isoPower</i> part.
L	L	L	L	X	X	Low power mode, converter disabled.
L	H	H	X	X	X	Note: This combination of RC _{IN} and RC _{SEL} is prohibited. Damage occurs on the secondary side of the converter due to excess output voltage at V _{ISO} . RC _{IN} must be either low or a PWM signal from a master <i>isoPower</i> part.

¹ PWM refers to the regulation control signal. This signal is derived from the secondary side regulator or from the RC_{IN} input, depending on the value of RC_{SEL}.

TYPICAL PERFORMANCE CHARACTERISTICS

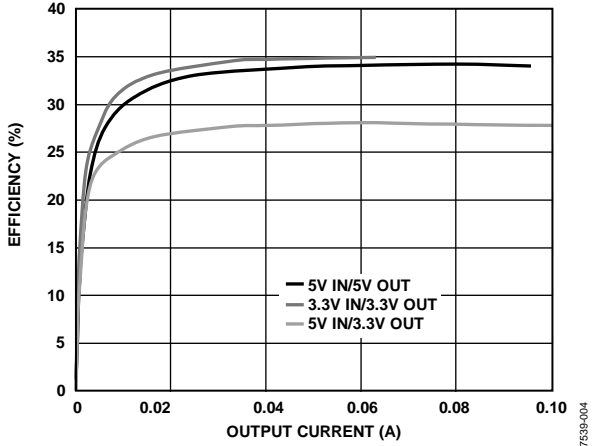

Figure 4. Typical Power Supply Efficiency in All Supported Power Configurations

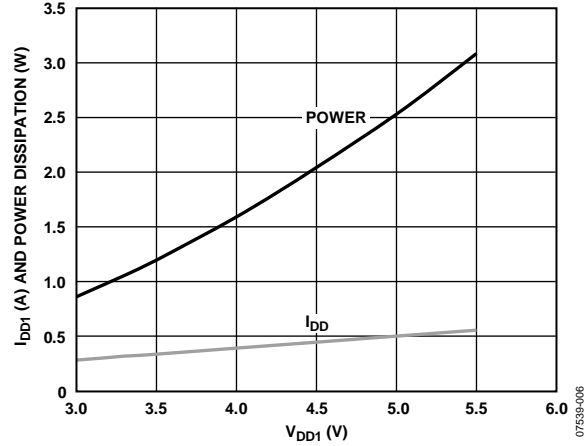

Figure 7. Typical Short-Circuit Input Current and Power vs. V_{DD1} Supply Voltage

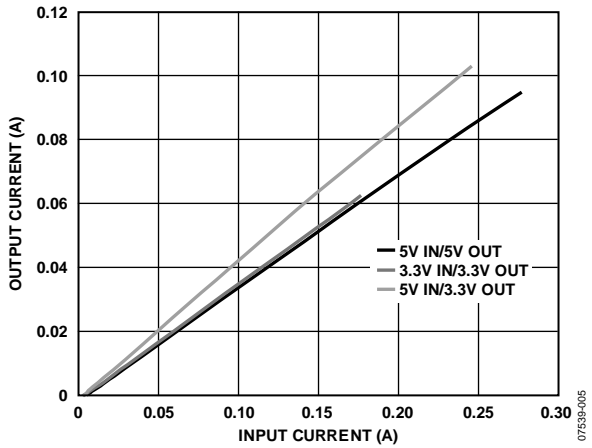

Figure 5. Typical Isolated Output Supply Current vs. External Load in All Supported Power Configurations

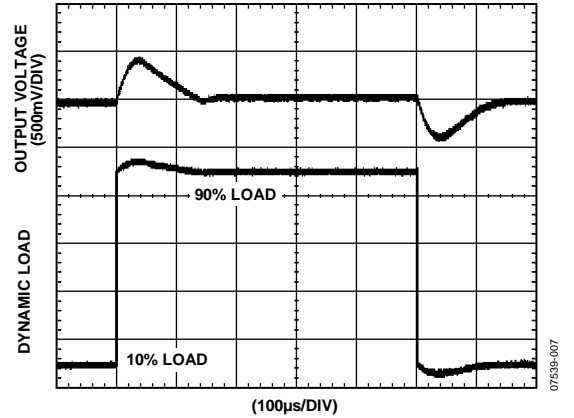

Figure 8. Typical V_{ISO} Transient Load Response, 5 V Output, 10% to 90% Load Step

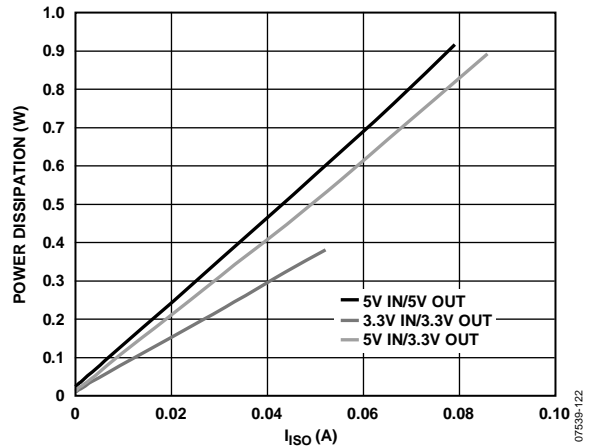

Figure 6. Typical Total Power Dissipation vs. I_{ISO} in All Supported Power Configurations

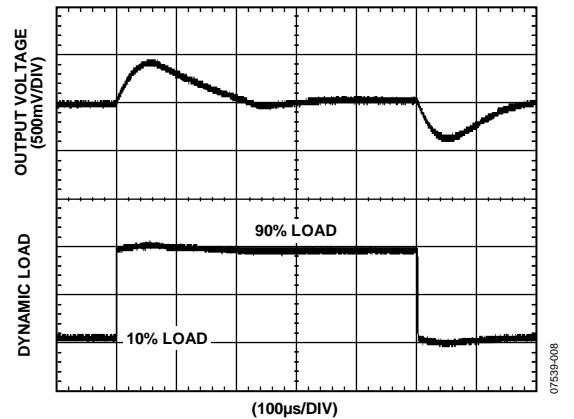

Figure 9. Typical Transient Load Response, 3 V Output, 10% to 90% Load Step

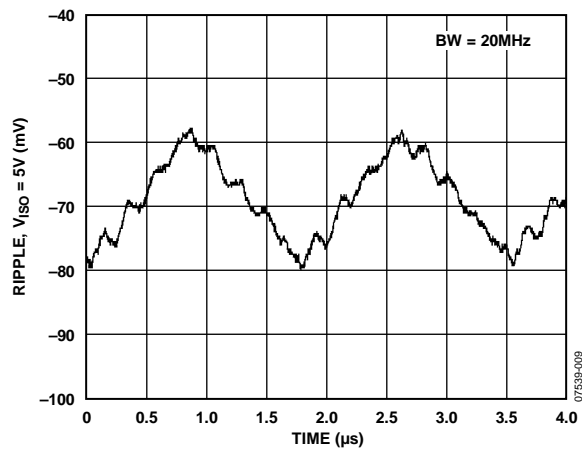

Figure 10. Typical $V_{ISO} = 5\text{ V}$, Output Voltage Ripple at 90% Load

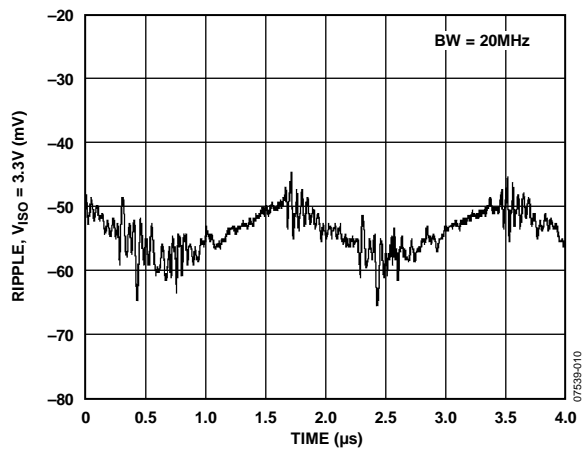

Figure 11. Typical $V_{ISO} = 3.3\text{ V}$, Output Voltage Ripple at 90% Load

ADuM5000

APPLICATIONS INFORMATION

The dc-to-dc converter section of the ADuM5000 works on principles that are common to most switching power supplies. It is a secondary side controller architecture with isolated pulse-width modulation (PWM) feedback. V_{DD1} power is supplied to an oscillating circuit that switches current into a chip-scale air core transformer. Power transferred to the secondary side is rectified and regulated to either 3.3 V or 5 V. The secondary (V_{ISO}) side controller regulates the output by creating a PWM control signal that is sent to the primary (V_{DD1}) side by a dedicated *iCoupler* data channel. The PWM modulates the oscillator circuit to control the power being sent to the secondary side. Feedback allows for significantly higher power and efficiency.

The ADuM5000 provides a regulation control output (RC_{OUT}) signal that can be connected to other *isoPower* devices. This feature allows a single regulator to control multiple power modules without contention. When auxiliary power modules are present, the V_{ISO} pins can be connected together to work as a single supply. Because there is only one feedback control path, the supplies work together seamlessly. The ADuM5000 can be a source of regulation control, as well as a being controlled by another *isoPower* device.

There is an undervoltage lockout with hysteresis in the V_{DD1} input protection circuit. When the input voltage rises above the lockout threshold, the dc-to-dc converter becomes active. The input voltage must be decreased below the turn-on threshold by the hysteresis value to disable the converter. This feature has many benefits in the power-up sequence of the converter, such as it ensures that the system supply rises to a minimum level before the ADuM5000 demands current. It also prevents any voltage drop due to converter current from turning the supply off and possibly oscillating.

PCB LAYOUT

The ADuM5000 digital isolator is a 0.5 W *isoPower* integrated dc-to-dc converter requiring no external interface circuitry for the logic interfaces. Power supply bypassing is required at the input and output supply pins (see Figure 12). The power supply section of the ADuM5000 uses a 180 MHz oscillator frequency to pass power efficiently through its chip scale transformers. In addition, the normal operation of the data section of the *iCoupler* introduces switching transients on the power supply pins. Bypass capacitors are required for several operating frequencies. Noise suppression requires a low inductance, high frequency capacitor, whereas ripple suppression and proper regulation require a large value capacitor. These are most conveniently connected between Pin 1 and Pin 2 for V_{DD1} , and between Pin 15 and Pin 16 for V_{ISO} . To suppress noise and reduce ripple, a parallel combination of at least two capacitors is required. The recommended capacitor values are 0.1 μF , and 10 μF . Best practice recommends using a very low inductance ceramic capacitor, or its equivalent, for the smaller value. The total lead length between both ends of the capacitor and the input power supply pin should not exceed

10 mm. Consider bypassing between Pin 1 and Pin 8 and between Pin 9 and Pin 16 unless both of the common ground pins are connected together close to the package.

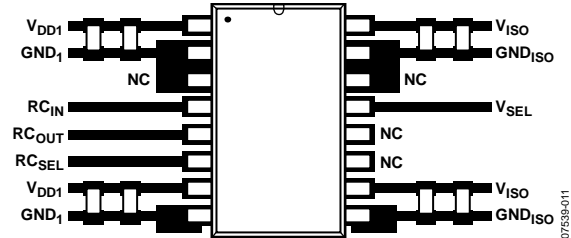

Figure 12. Recommended PCB Layout

In applications involving high common-mode transients, ensure that board coupling across the isolation barrier is minimized. Furthermore, design the board layout such that any coupling that does occur equally affects all pins on a given component side. Failure to ensure this can cause voltage differentials between pins exceeding the absolute maximum ratings for the device as specified in Table 10, thereby leading to latch-up and/or permanent damage.

The ADuM5000 is a power device that dissipates about 1 W of power when fully loaded. Because it is not possible to apply a heat sink to an isolation device, the device primarily depends on heat dissipation into the PCB through the GND pins. If the device is used at high ambient temperatures, provide a thermal path from the GND pins to the PCB ground plane. The board layout in Figure 12 shows enlarged pads for Pin 2, Pin 8, Pin 9, and Pin 15. Implement multiple vias from the pad to the ground plane to significantly reduce the temperature inside the chip. The dimensions of the expanded pads are at the discretion of the designer and dependent on the available board space.

EMI CONSIDERATIONS

It is necessary for the dc-to-dc converter section of the ADuM5000 to operate at 180 MHz to allow efficient power transfer through the small transformers. This creates high frequency currents that can propagate in circuit board ground and power planes, causing edge emissions and dipole radiation between the input and output ground planes. Grounded enclosures are recommended for applications that use these devices. If grounded enclosures are not possible, follow good RF design practices in the layout of the PCB. See www.analog.com for the most current PCB layout recommendations specifically for the ADuM5000.

THERMAL ANALYSIS

The ADuM5000 consists of four internal silicon die, attached to a split lead frame with two die attach paddles. For the purposes of thermal analysis, it is treated as a thermal unit with the highest junction temperature reflected in the θ_{JA} from Table 5. The value of θ_{JA} is based on measurements taken with the part mounted on a JEDEC standard 4-layer board with fine width traces and still air. Under normal operating conditions, the ADuM5000 operates at full load across the full temperature range without

derating the output current. However, following the recommendations in the PCB Layout section decreases the thermal resistance to the PCB allowing increased thermal margin at high ambient temperatures.

CURRENT LIMIT AND THERMAL OVERLOAD PROTECTION

The ADuM5000 is protected against damage due to excessive power dissipation by thermal overload protection circuits. Thermal overload protection limits the junction temperature to a maximum of 150°C (typical). Under extreme conditions (that is, high ambient temperature and power dissipation), when the junction temperature starts to rise above 150°C, the PWM is turned off, reducing the output current to zero. When the junction temperature drops below 130°C (typical), the PWM turns on again, restoring the output current to its nominal value.

Consider the case where a hard short from V_{ISO} to ground occurs. At first, the ADuM5000 reaches its maximum current, which is proportional to the voltage applied at V_{DD1} . Power dissipates on the primary side of the converter (see Figure 7). If self-heating of the junction becomes great enough to cause its temperature to rise above 150°C, thermal shutdown activates, turning off the PWM and reducing the output current to zero. As the junction temperature cools and drops below 130°C, the PWM turns on and power dissipates again on the primary side of the converter, causing the junction temperature to rise to 150°C again. This thermal oscillation between 130°C and 150°C causes the part to cycle on and off as long as the short remains at the output.

Thermal limit protections are intended to protect the device against accidental overload conditions. For reliable operation, externally limit device power dissipation to prevent junction temperatures from exceeding 130°C.

POWER CONSIDERATIONS

The ADuM5000 converter primary side is protected from premature operation by undervoltage lockout (UVLO) circuitry. Below the minimum operating voltage, the power converter holds its oscillator inactive.

When the primary side oscillator begins to operate, it transfers power to the secondary power circuits. The secondary V_{ISO} voltage starts below its UVLO limit making it inactive and unable to generate a regulation control signal. The primary side power oscillator is allowed to free run under this condition, supplying the maximum amount of power to the secondary. As the sec-

ondary voltage rises to its regulation setpoint, a large inrush current transient is present at V_{DD1} . When the regulation point is reached, the regulation control circuit produces the regulation control signal that modulates the oscillator on the primary side. The V_{DD1} current is then reduced and is proportional to the load current. The inrush current is less than the short-circuit current shown in Figure 7. The duration of the inrush depends on the V_{ISO} loading conditions and the current and voltage available at the V_{DD1} pin.

INCREASING AVAILABLE POWER

The ADuM5000 device is designed with the capability of running in combination with other compatible *isoPower* devices. The RC_{OUT} , RC_{IN} , and RC_{SEL} pins allow the ADuM5000 to provide its PWM signal to another device through the RC_{OUT} pin acting as a master. It can also receive a PWM signal from another device through the RC_{IN} pin and act as a slave to that control signal. The RC_{SEL} pin chooses whether the part acts as a master or slave device. When the ADuM5000 is acting as a slave, its power is regulated by the master device allowing multiple *isoPower* parts to be combined in parallel while sharing the load equally. When the ADuM5000 is configured as a master/standalone unit, it generates its own PWM feedback signal to regulate itself and slave devices.

The ADuM5000 can act as a master or a slave device, the ADuM5401 through the ADuM5404 devices can only serve as master/standalone, and the ADuM520x can only be a slave/standalone device. This means that the ADuM5000, ADuM520x, and ADuM5401, ADuM5402, ADuM5403, and ADuM5404 can only be used in certain master slave combinations as listed in Table 14.

Table 14. Allowed Combinations of *isoPower* Parts

Master	Slave		
	ADuM5000	ADuM520x	ADuM5401 to ADuM5404
ADuM5000	Yes	Yes	No
ADuM520x	No	No	No
ADuM5401 to ADuM5404	Yes	Yes	No

The allowed combinations of master and slave configured parts listed in Table 14 is sufficient for any combination of power and channel count. Table 15 illustrates how *isoPower* devices can provide many combinations of data channel count and multiples of the single unit power.

ADuM5000

Table 15. Configurations for Power and Data Channels

Power Units	Number of Data Channels			
	0	2	4	6
1-Unit Power	ADuM5000 master	ADuM520x master	ADuM5401 to ADuM5404 master	ADuM5401 to ADuM5404 master ADuM121x
2-Unit Power	ADuM5000 master ADuM5000 slave	ADuM5000 master ADuM520x slave	ADuM5401 to ADuM5404 master ADuM520x slave	ADuM5401 to ADuM5404 master ADuM520x slave
3-Unit Power	ADuM5000 master ADuM5000 slave ADuM5000 slave	ADuM5000 master ADuM5000 slave ADuM520x slave	ADuM5401 to ADuM5404 master ADuM5000 slave ADuM5000 slave	ADuM5401 to ADuM5404 master ADuM520x slave ADuM5000 slave

Another feature that is allowed by the RC_{SEL} and RC_{IN} control architecture is the ability to completely shut down the oscillator in the dc-to-dc converter. This places the part in a low power standby mode and reduces the current draw to a fraction of a milliamp. When the ADuM5000 is placed in slave mode by driving RC_{SEL} low, the oscillator is controlled by RC_{IN} . If RC_{IN} is held low, the oscillator is shut down and the part is in low power standby. With no oscillator driving power to the secondary, V_{ISO} turns off. This mode is useful for applications where an isolated subsystem may be shut down to conserve power. To reactivate the power module, simply drive RC_{SEL} high and the power supply resumes operation.

INSULATION LIFETIME

All insulation structures eventually break down when subjected to voltage stress over a sufficiently long period. The rate of insulation degradation is dependent on the characteristics of the voltage waveform applied across the insulation. In addition to the testing performed by the regulatory agencies, Analog Devices carries out an extensive set of evaluations to determine the lifetime of the insulation structure within the ADuM5000.

Analog Devices performs accelerated life testing using voltage levels higher than the rated continuous working voltage. Acceleration factors for several operating conditions are determined. These factors allow calculation of the time to failure at the actual working voltage. The values shown in Table 11 summarize the peak voltage for 50 years of service life for a bipolar ac operating condition, and the maximum CSA/VDE approved working voltages. In many cases, the approved working voltage is higher than 50-year service life voltage. Operation at these high working voltages can lead to shortened insulation life in some cases.

The insulation lifetime of the ADuM5000 depends on the voltage waveform imposed across the isolation barrier. The iCoupler insulation structure degrades at different rates depending on whether the waveform is bipolar ac, unipolar ac, or dc. Figure 13, Figure 14, and Figure 15 illustrate these different isolation voltage waveforms.

Bipolar ac voltage is the most stringent environment. The goal of a 50-year operating lifetime under the ac bipolar condition determines the maximum working voltage that Analog Devices recommends.

In the case of unipolar ac or dc voltage, the stress on the insulation is significantly lower. This allows operation at higher working voltages while still achieving a 50-year service life. The working voltages listed in Table 11 can be applied while maintaining the 50-year minimum lifetime, provided the voltage conforms to either the unipolar ac or dc voltage cases. Treat any cross insulation voltage waveform that does not conform to Figure 14 or Figure 15 as a bipolar ac waveform and limit its peak voltage to the 50-year lifetime voltage value listed in Table 11. The voltage presented in Figure 14 is shown as sinusoidal for illustration purposes only. It is meant to represent any voltage waveform varying between 0 V and some limiting value. The limiting value can be positive or negative, but the voltage cannot cross 0 V.

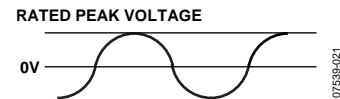

Figure 13. Bipolar AC Waveform

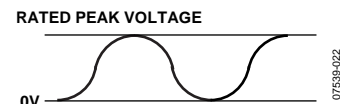

Figure 14. Unipolar AC Waveform

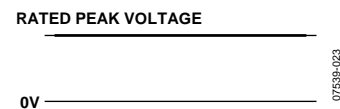
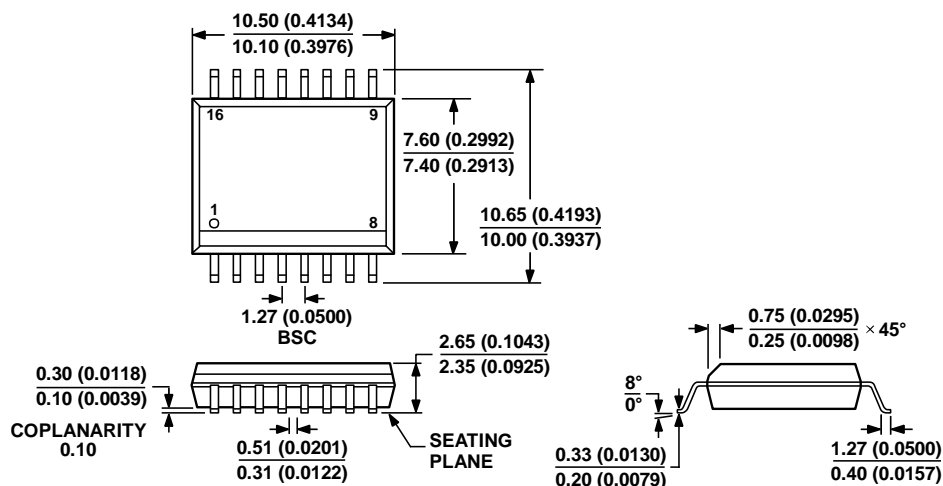

Figure 15. DC Waveform

OUTLINE DIMENSIONS



COMPLIANT TO JEDEC STANDARDS MS-013-AA
 CONTROLLING DIMENSIONS ARE IN MILLIMETERS; INCH DIMENSIONS
 (IN PARENTHESES) ARE ROUNDED-OFF MILLIMETER EQUIVALENTS FOR
 REFERENCE ONLY AND ARE NOT APPROPRIATE FOR USE IN DESIGN.

Figure 16. 16-Lead Standard Small Outline Package [SOIC_W]
 Wide Body (RW-16)
 Dimensions shown in millimeters and (inches)

032707-B

ORDERING GUIDE

Model	Temperature Range	Package Description	Package Option
ADuM5000ARWZ ^{1, 2}	-40°C to +105°C	16-Lead SOIC_W	RW-16

¹ Z = RoHS Compliant Part.

² Tape and reel are available. The additional -RL suffix designates a 13-inch (1,000 units) tape and reel option.

ADuM5000

NOTES