

USB-A-S-RA

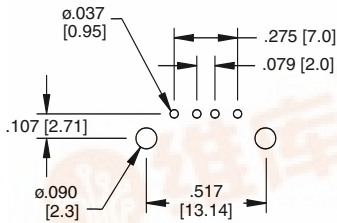

Recommended PCB Layout

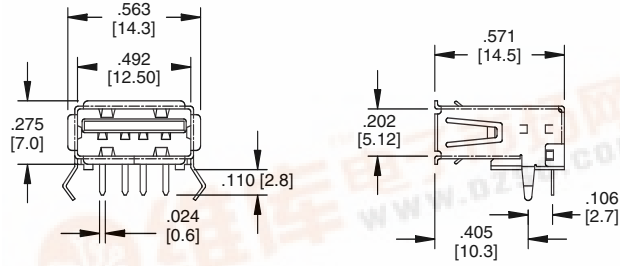

USB-A-S-RA-SMT

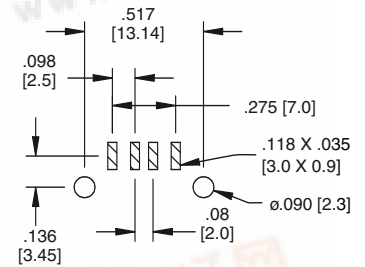
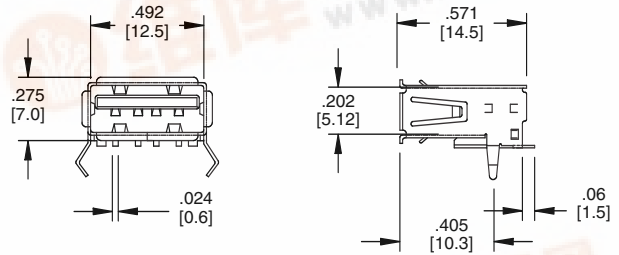

Recommended PCB Layout



USB-A-S-VT

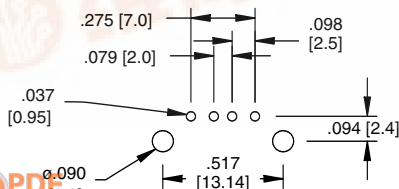
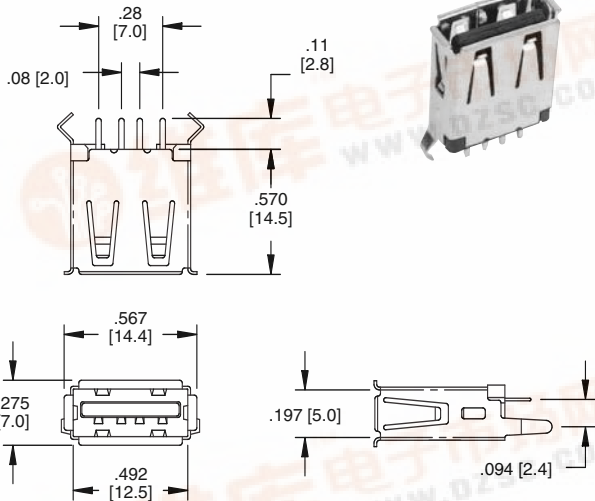

Recommended PCB Layout
(Bottom View)



USB-A-S-RA-TSMT

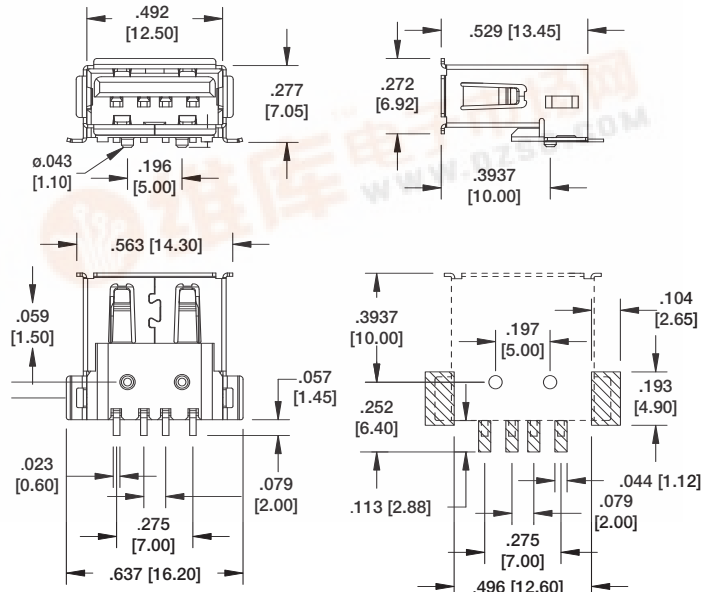

Recommended PCB Layout

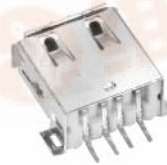

USB-A-S-RU

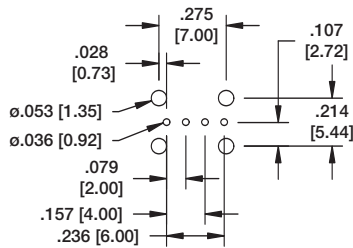
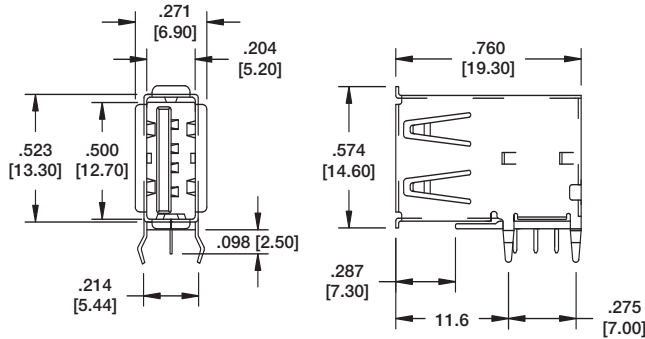

Recommended PCB Layout

USB-A-S-RA-FS

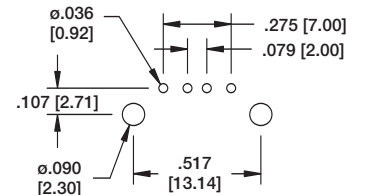
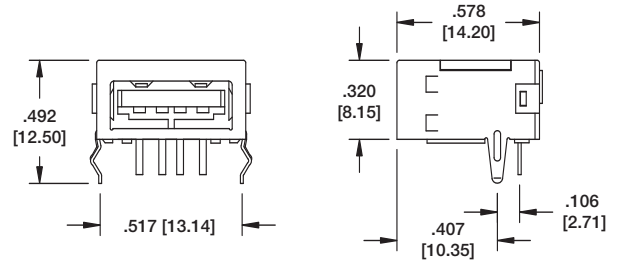

Recommended PCB Layout

USB-AP-S-RA

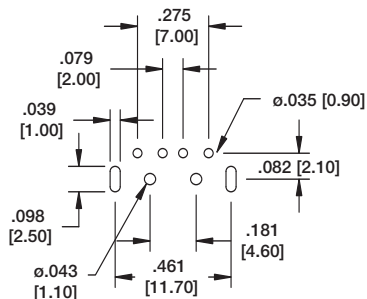
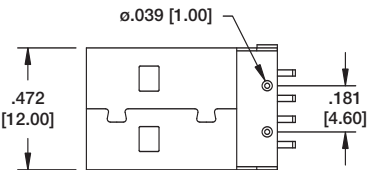
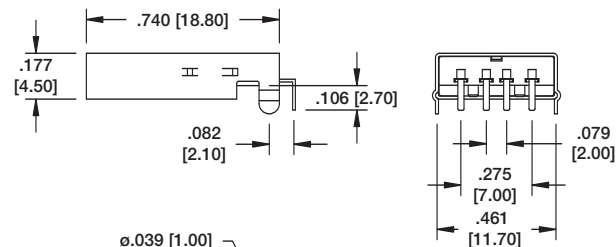

Recommended PCB Layout

USB-AP-S-RA-SMT

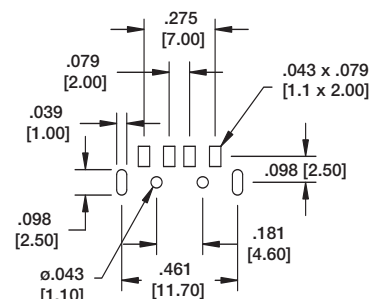
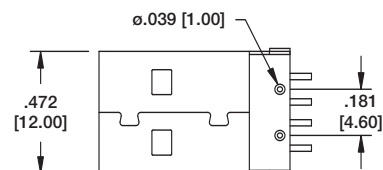
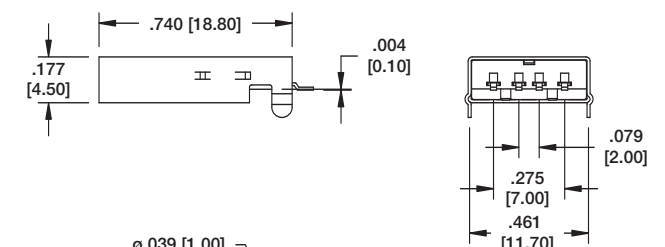

Recommended PCB Layout