

查询ADC-009-3供应商

捷多邦, 专业PCB打样工厂, 24小时加急出货

# ADAM TECH

# DC POWER JACKS

Adam Technologies, Inc.

PC BOARD AND PANEL MOUNT

ADC SERIES

## ADC-007



ADC-007-3

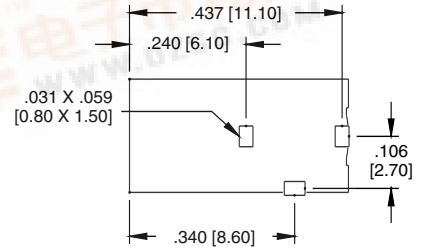
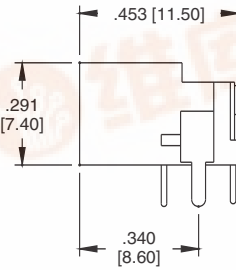
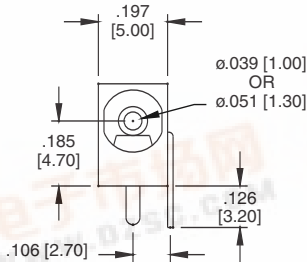

Recommended PCB Layout

## ADC-009



ADC-009-3

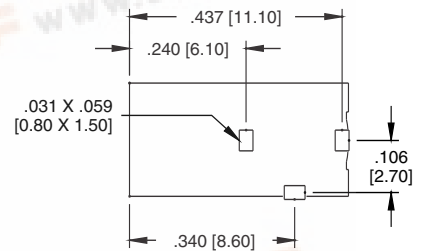
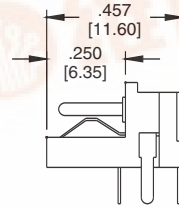
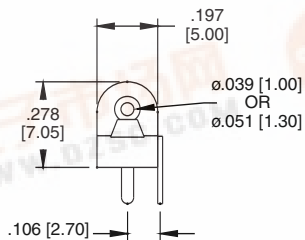

Recommended PCB Layout

## ADC-011

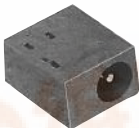

ADC-011-3

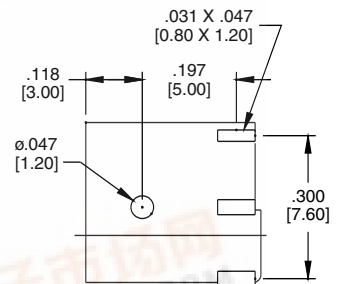
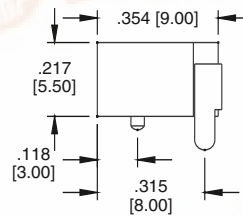
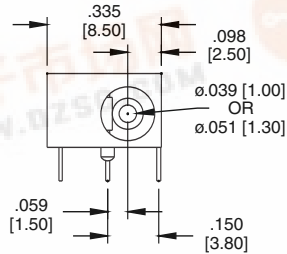

Recommended PCB Layout

## ADC-021

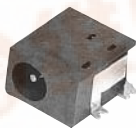

ADC-021-3

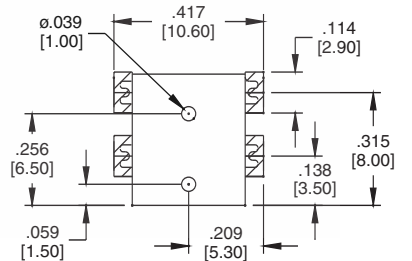
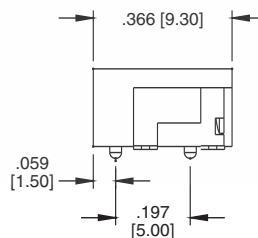
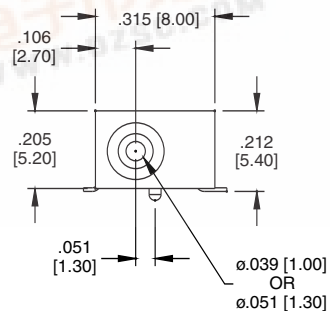

Recommended PCB Layout



## ADC-029



ADC-029-1

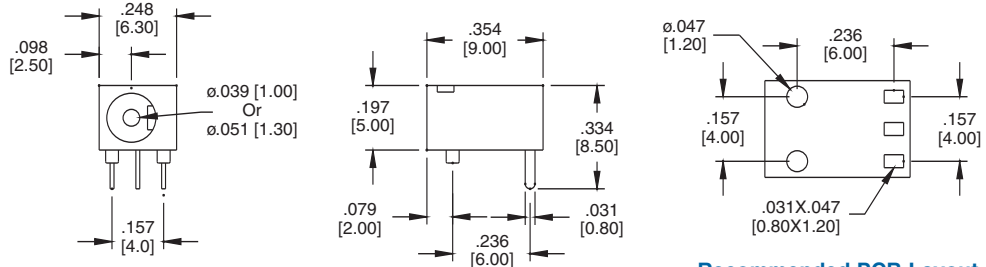

Recommended PCB Layout

## ADC-002



ADC-002-2

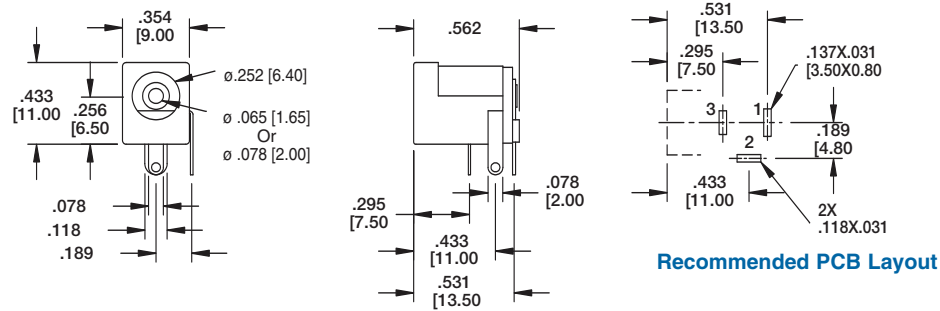

Recommended PCB Layout

## ADC-024



ADC-024-8

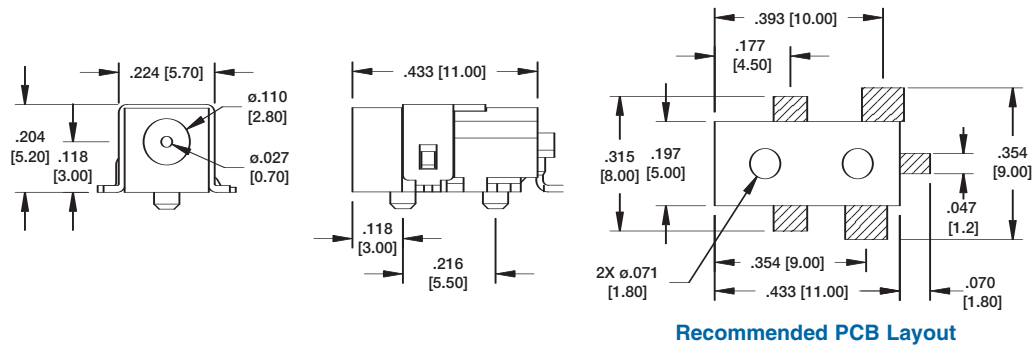

Recommended PCB Layout

## ADC-028



ADC-028-2

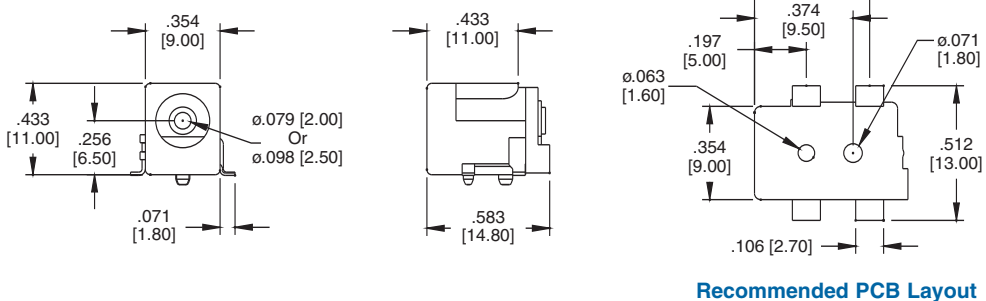

Recommended PCB Layout

### ADC-010



ADC-010-1

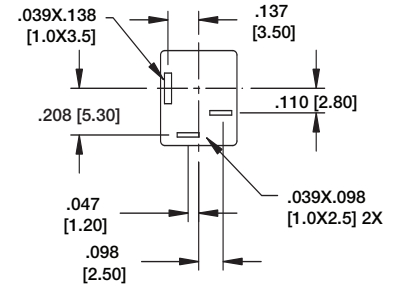
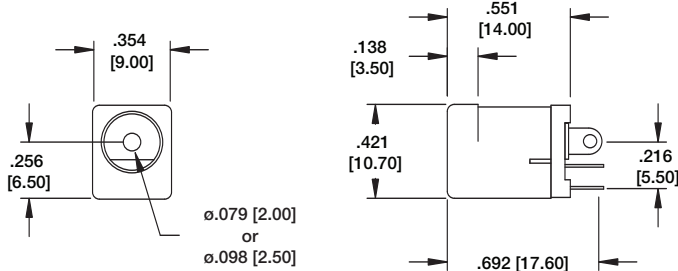

Recommended PCB Layout

### ADC-015



ADC-015-2

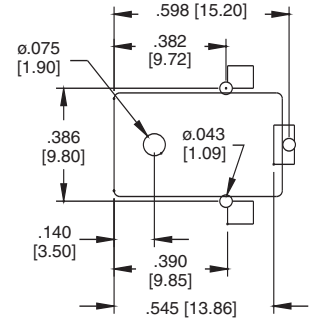
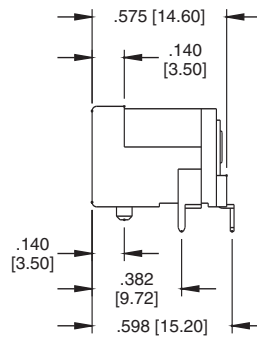
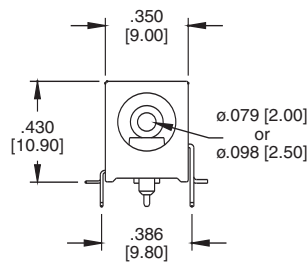

Recommended PCB Layout

### ADC-045A



ADC-045A-1

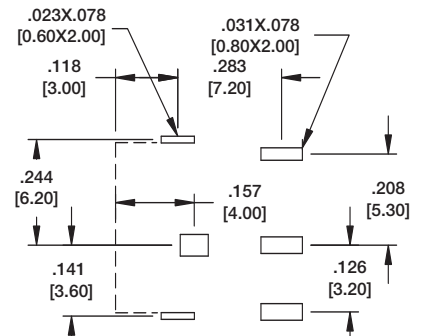
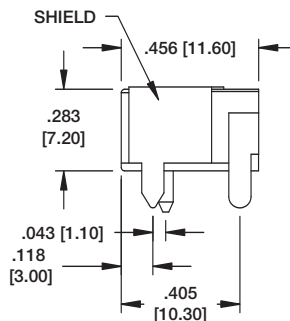
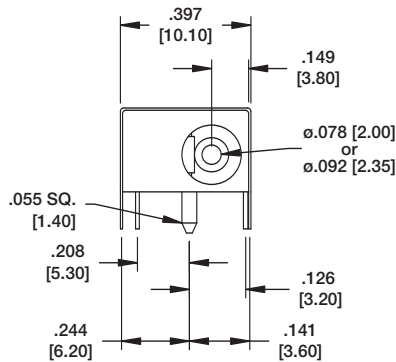

Recommended PCB Layout

### DC POWER PLUG WITH STRAIN RELIEF

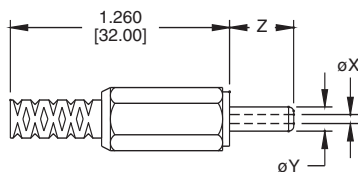

PLUG WITH STRAIN RELIEF	X	Y	Z
ADP-X/Y/Z-SR	$\phi .039$ [1.00]	$\phi .137$ [3.50]	.374 [9.50]
ADP-X/Y/Z-SR	$\phi .082$ [2.10]	$\phi .216$ [5.50]	.374 [9.50]
ADP-X/Y/Z-SR	$\phi .098$ [2.50]	$\phi .216$ [5.50]	.374 [9.50]

### DC POWER PLUG WITHOUT STRAIN RELIEF

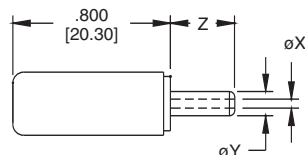

PLUG WITHOUT STRAIN RELIEF	X	Y	Z
ADP-X/Y/Z	$\phi .039$ [1.00]	$\phi .137$ [3.50]	.374 [9.50]
ADP-X/Y/Z	$\phi .082$ [2.10]	$\phi .216$ [5.50]	.374 [9.50]
ADP-X/Y/Z	$\phi .098$ [2.50]	$\phi .216$ [5.50]	.374 [9.50]