

查询BH-25供应商

捷多邦, 专业PCB打样工厂, 24小时加急出货

# ADAM TECH

Adam Technologies, Inc.

# BATTERY HOLDERS

## COIN CELL BATTERY HOLDERS

BH SERIES

**BH-25**  
COIN CELL BATTERY HOLDER

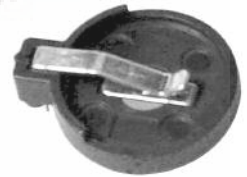
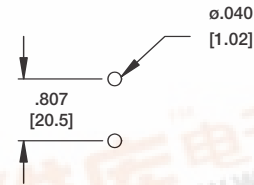
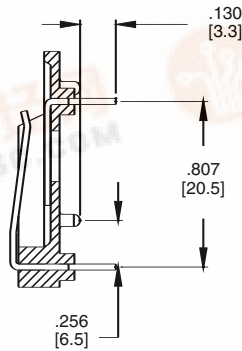
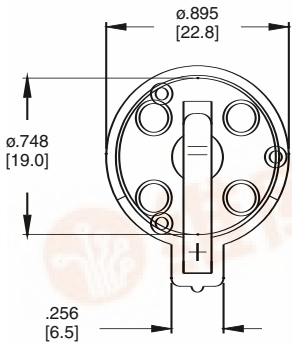

**BH-25-1**

Recommended PCB Layout

**BH-26**  
COIN CELL BATTERY HOLDER

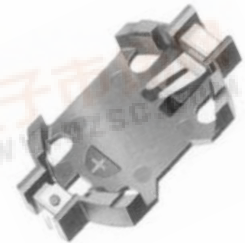
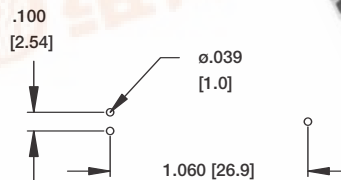
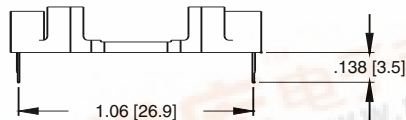
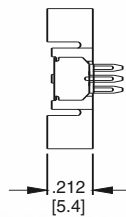
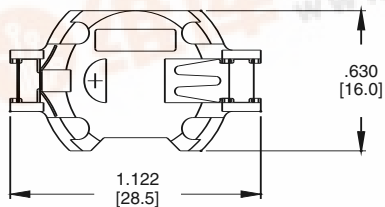

**BH-26-1**

Recommended PCB Layout

**BH-27**  
COIN CELL BATTERY HOLDER

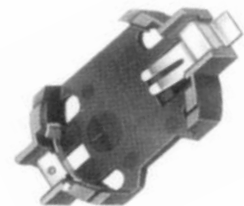
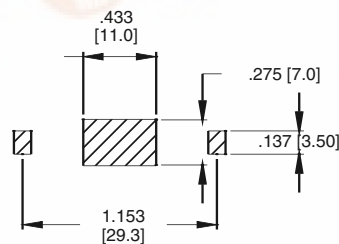
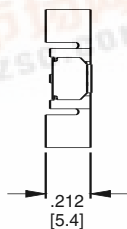
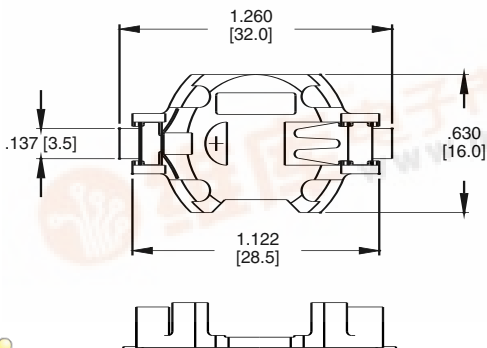

**BH-27-5**

Recommended PCB Layout

