

TECHNICAL DATA

DUAL OPERATIONAL AMPLIFIER

IL4580

GENERAL DESCRIPTION

The IL4580 is the dual operational amplifier, specially designer for improving the tone control, which is most suitable for the audio application.

Featuring noiseless, higher gain bandwidth, high output current and low distortion ratio, and it is most suitable not only for acoustic electronic parts of audio pre-amp and active filter, but also for the industrial measurement tools. It is also suitable for the head phone amp at higher output current, and further more, it can be applied for the handy type set operational amplifier of general purpose in application of low voltage single supply type which is properly biased of the input low voltage source.

FEATURES

- Operating Voltage ($\pm 2\text{ V} \sim \pm 18\text{ V}$)
- Wide Gain Bandwidth Product (15 MHz typ.)
- Slew Rate ($5\text{ V}/\mu\text{s}$ typ.)
- Bipolar Technology

BLOCK DIAGRAM

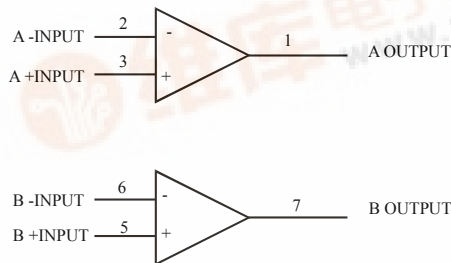

N SUFFIX PLASTIC

D SUFFIX SOIC

ORDERING INFORMATION
 IL4580N Plastic
 IL4580D SOIC
 $T_A = -40^\circ$ to 85° C
 for all packages.

PIN ASSIGNMENT

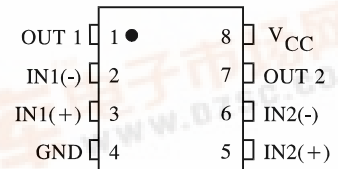

EQUIVALENT CIRCUIT (1/2 Show)

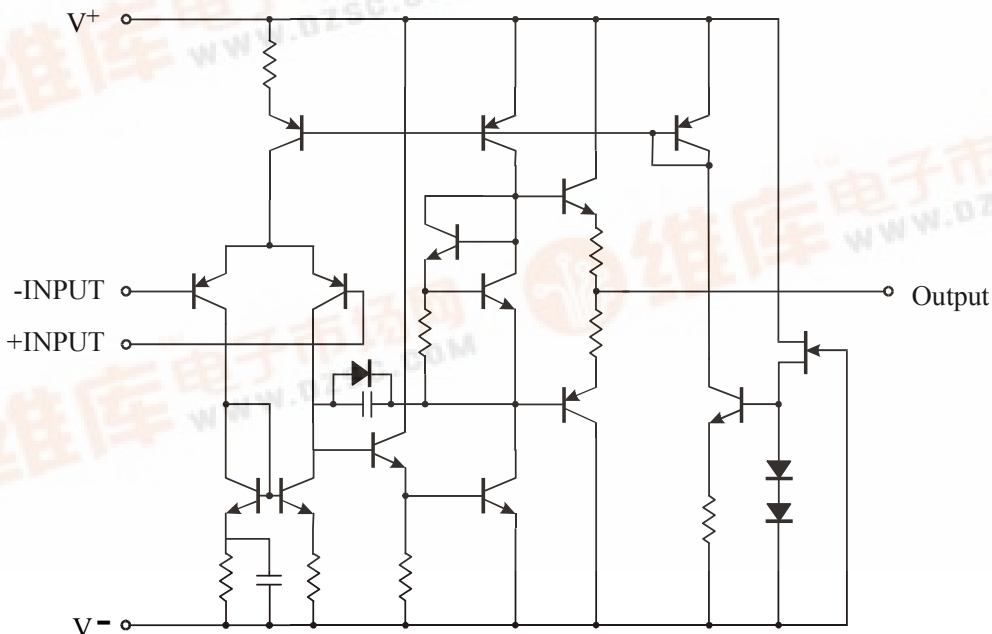

ABSOLUTE MAXIMUM RATINGS (Ta=25°C)

Symbol	Parameter	Ratings	Unit
V ⁺ /V ⁻	Supply Voltage	±18	V
V _{ID}	Differential Input Voltage	30	V
V _{IC}	Input Voltage	±15*	V
I _O	Output Current	±50	mA
Topr	Operation Temperature Range	-40 ~ +85	°C
Tstg	Storage Temperature Range	-60 ~ +125	°C

* For supply voltage less than ±15 V, the absolute maximum input voltage is equal to the supply voltage.

ELECTRICAL CHARACTERISTICS (Ta=25°C, V⁺/V⁻ = ±15)

Symbol	Parameter	Test Condition	Min	Max	Unit
V _{IO}	Input Offset Voltage	R _S ≤ 10 kΩ	-	3	mV
I _{IO}	Input Offset Current		-	200	nA
I _B	Input Bias Current		-	500	nA
R _{IN}	Input Resistance		0.3	-	MΩ
A _V	Large Signal Voltage Gain	R _L ≥ 2 kΩ, V _O = ±10 V	90	-	dB
V _{OM}	Output Voltage Swing	R _L ≥ 2 kΩ	±12	-	V
V _{ICM}	Input Common Mode Voltage Range		±12	-	V
CMR	Common Mode Rejection Ratio	R _S ≤ 10 kΩ	80	-	dB
SVR	Supply Voltage Rejection Ratio	R _S ≤ 10 kΩ	80	-	dB
I _{CC}	Operating Current		-	9	mA
SR	Slew Rate	R _L ≥ 2 kΩ	4	6	V/μs

■ TYPICAL CHARACTERISTICS

Maximum Output Voltage Swing vs. Load Resistance

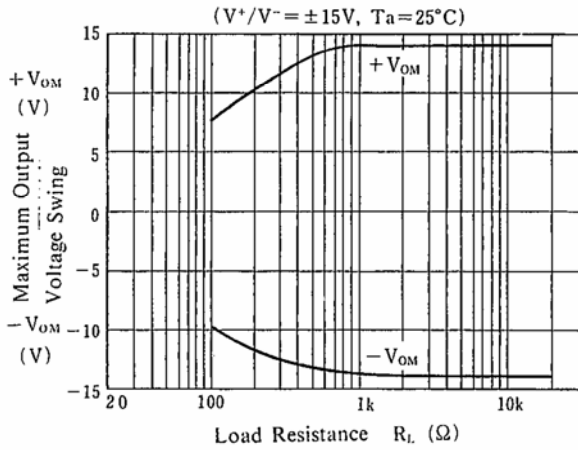

Maximum Output Voltage Swing vs. Frequency

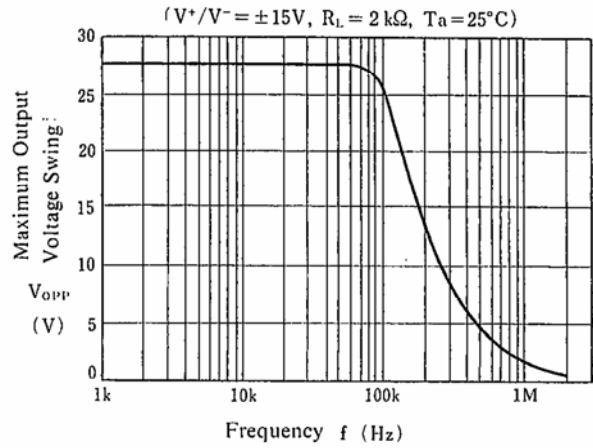

Output Voltage Swing vs. Output Current

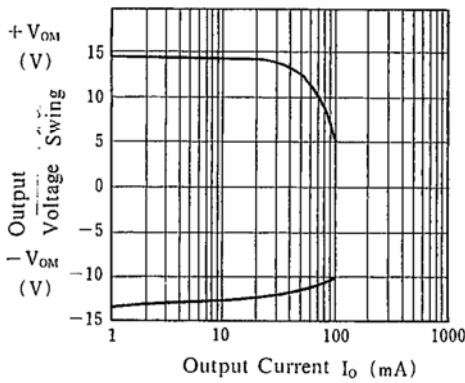

Equivalent Input Noise Voltage vs. Frequency

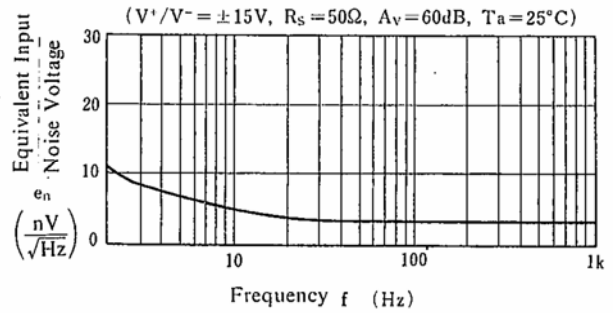

Operating Current vs. Temperature

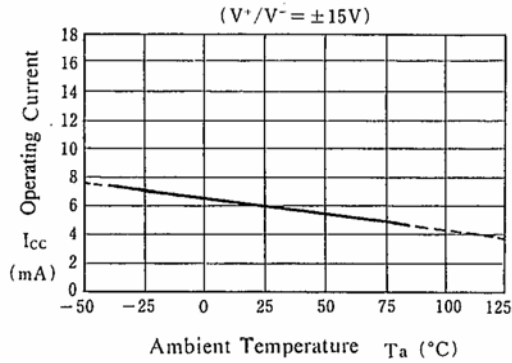

Output Voltage Swing vs. Temperature

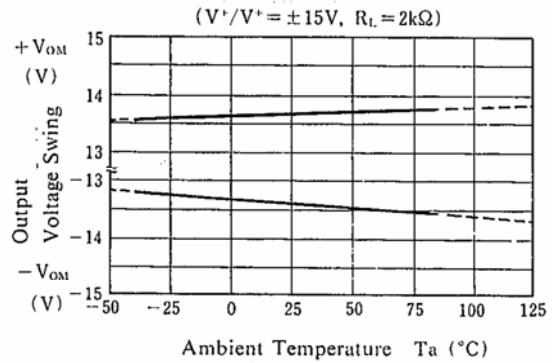

■ TYPICAL CHARACTERISTICS

Input Offset Voltage vs. Temperature

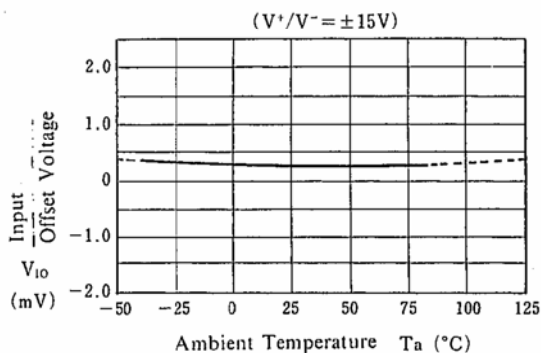

Input Bias Current vs. Temperature

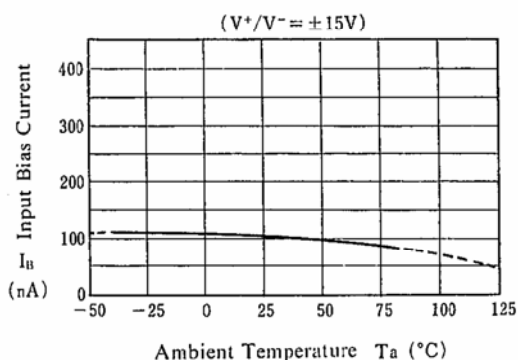

Maximum Output Voltage Swing vs. Operating Voltage

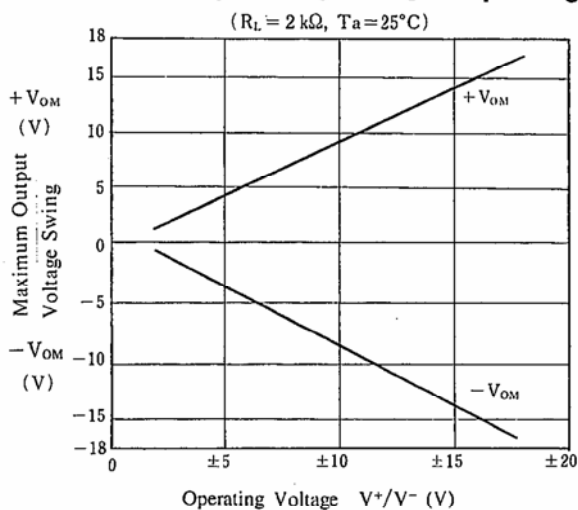

Operating Current vs. Operating Voltage

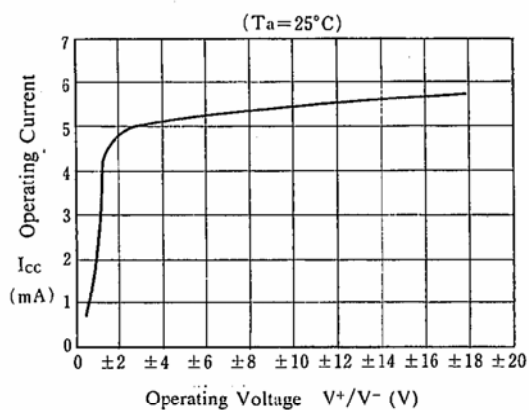

Total Harmonic Distortion vs. Output Voltage

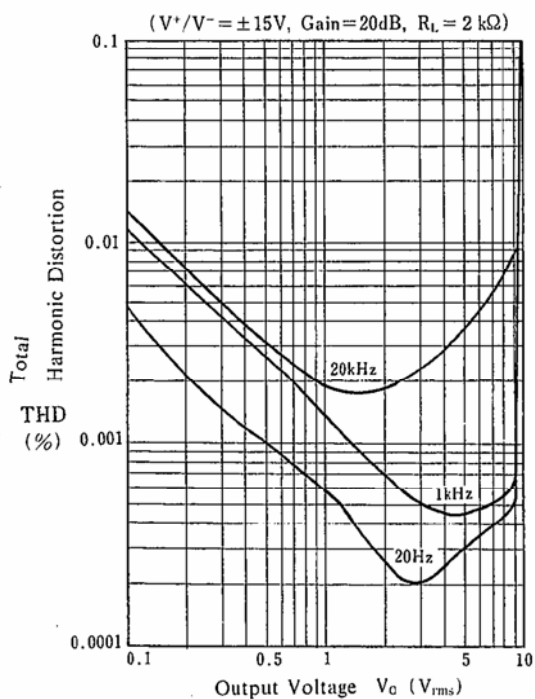

Voltage Gain, Phase vs. Frequency

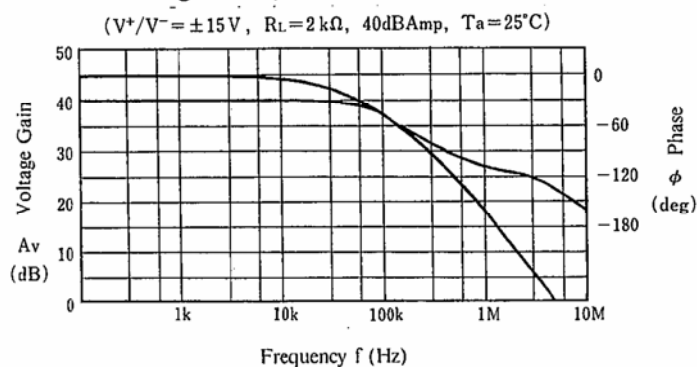

**N SUFFIX PLASTIC DIP
(MS - 001BA)**

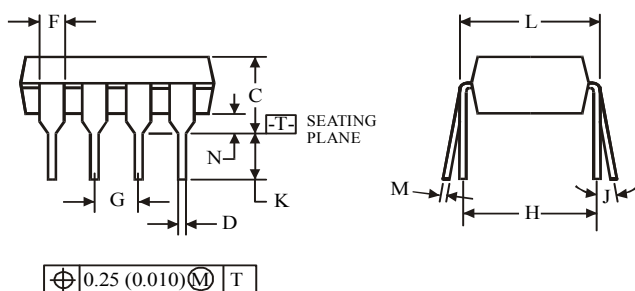
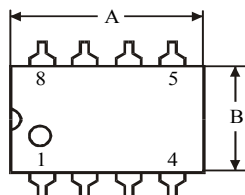
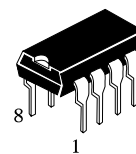

$\oplus 0.25 (0.010) \text{ (M) T}$

Symbol	Dimension, mm	
	MIN	MAX
A	8.51	10.16
B	6.1	7.11
C		5.33
D	0.36	0.56
F	1.14	1.78
G	2.54	
H	7.62	
J	0°	10°
K	2.92	3.81
L	7.62	8.26
M	0.2	0.36
N	0.38	

NOTES:

- Dimensions "A", "B" do not include mold flash or protrusions.
Maximum mold flash or protrusions 0.25 mm (0.010) per side.

**D SUFFIX SOIC
(MS - 012AA)**

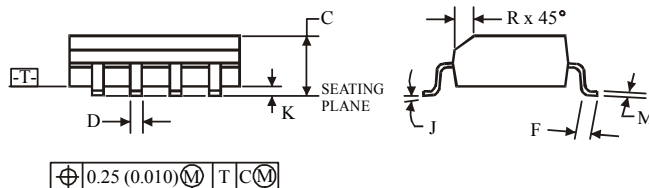
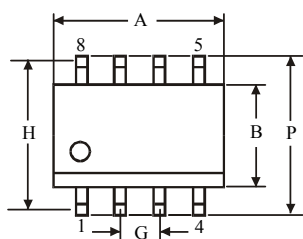
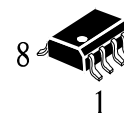

$\oplus 0.25 (0.010) \text{ (M) T C (M)}$

Symbol	Dimension, mm	
	MIN	MAX
A	4.8	5
B	3.8	4
C	1.35	1.75
D	0.33	0.51
F	0.4	1.27
G	1.27	
H	5.72	
J	0°	8°
K	0.1	0.25
M	0.19	0.25
P	5.8	6.2
R	0.25	0.5

NOTES:

- Dimensions A and B do not include mold flash or protrusion.
- Maximum mold flash or protrusion 0.15 mm (0.006) per side
for A; for B - 0.25 mm (0.010) per side.