

Inchange Semiconductor

Product Specification

Silicon NPN Power Transistors

2SC5287

DESCRIPTION

- With TO-3PN package
- High voltage,high speed switching

APPLICATIONS

- For switching regulator and general purpose applications

PINNING

PIN	DESCRIPTION
1	Base
2	Collector;connected to mounting base
3	Emitter

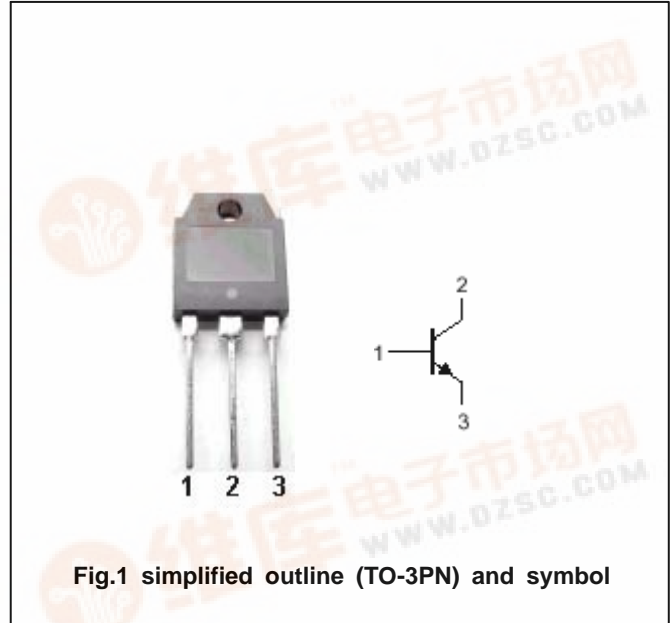

Absolute maximum ratings(Ta=)

SYMBOL	PARAMETER	CONDITIONS	VALUE	UNIT
V _{CBO}	Collector-base voltage	Open emitter	900	V
V _{CEO}	Collector-emitter voltage	Open base	550	V
V _{EBO}	Emitter-base voltage	Open collector	7	V
I _C	Collector current		5	A
I _{CM}	Collector current-peak		10	A
I _B	Base current		2.5	A
P _C	Collector power dissipation	T _C =25	80	W
T _j	Junction temperature		150	
T _{stg}	Storage temperature		-55~150	

Silicon NPN Power Transistors

2SC5287

CHARACTERISTICS

T_j=25 unless otherwise specified

SYMBOL	PARAMETER	CONDITIONS	MIN	TYP.	MAX	UNIT
V _{(BR)CEO}	Collector-emitter breakdown voltage	I _C =10mA ; I _B =0	550			V
V _{CEsat}	Collector-emitter saturation voltage	I _C =1.8A; I _B =0.36A			0.5	V
V _{BEsat}	Base-emitter saturation voltage	I _C =1.8A; I _B =0.36A			1.2	V
I _{CBO}	Collector cut-off current	V _{CB} =800V; I _E =0			100	μA
I _{EBO}	Emitter cut-off current	V _{EB} =7V; I _C =0			100	μA
h _{FE}	DC current gain	I _C =1.8A ; V _{CE} =4V	10		25	
C _{OB}	Output capacitance	I _E =0 ; V _{CB} =10V; f=1MHz		50		pF
f _T	Transition frequency	I _E =-0.35A ; V _{CE} =12V		6		MHz
Switching times						
t _{on}	Turn-on time	I _C =1.8A; R _L =139 I _{B1} =0.27A; I _{B2} =-0.9A V _{CC} =250V			0.7	μs
t _s	Storage time				4.0	μs
t _f	Fall time				0.5	μs

Silicon NPN Power Transistors

2SC5287

PACKAGE OUTLINE

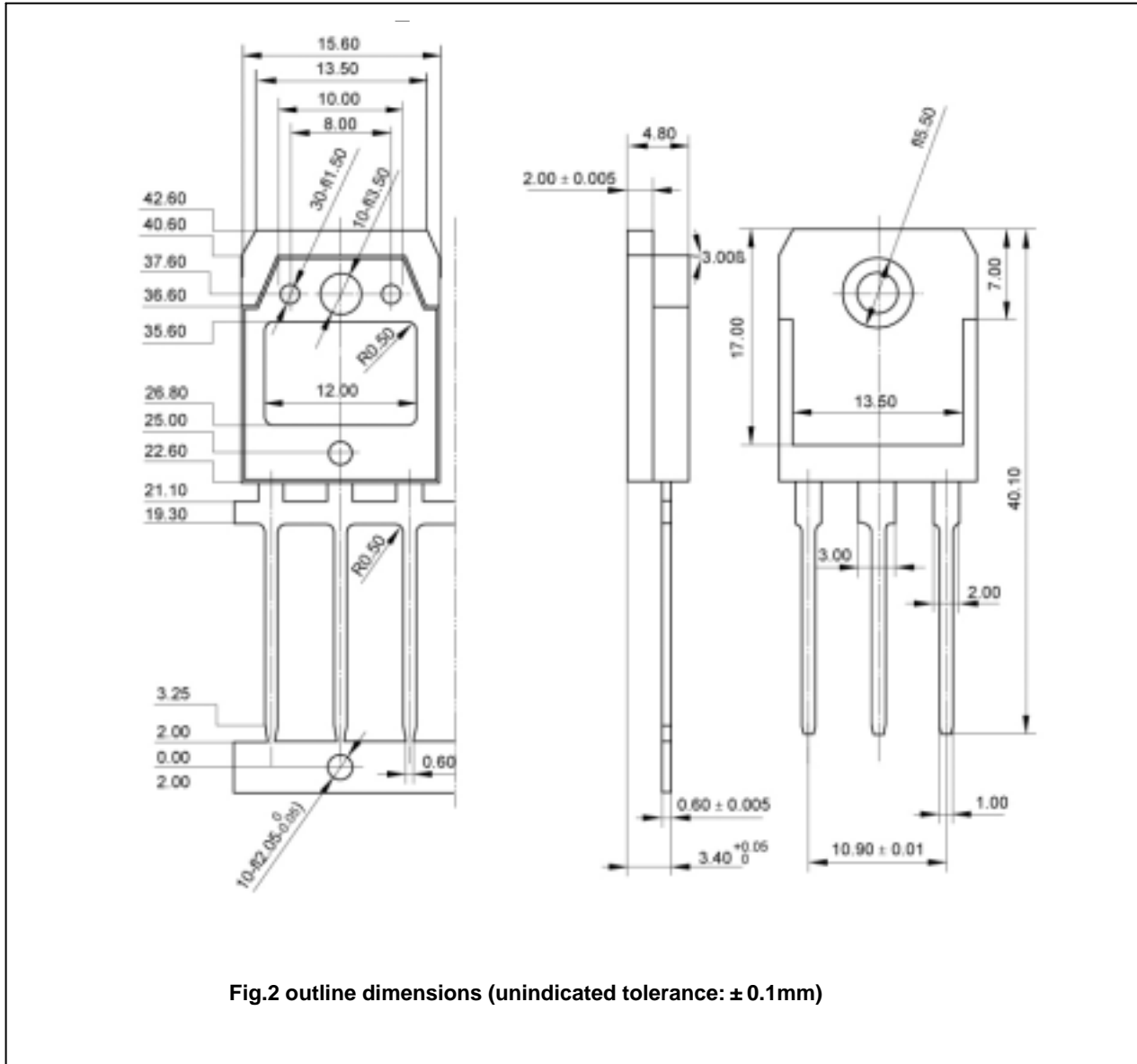

Fig.2 outline dimensions (unindicated tolerance: ± 0.1mm)

Silicon NPN Power Transistors

2SC5287

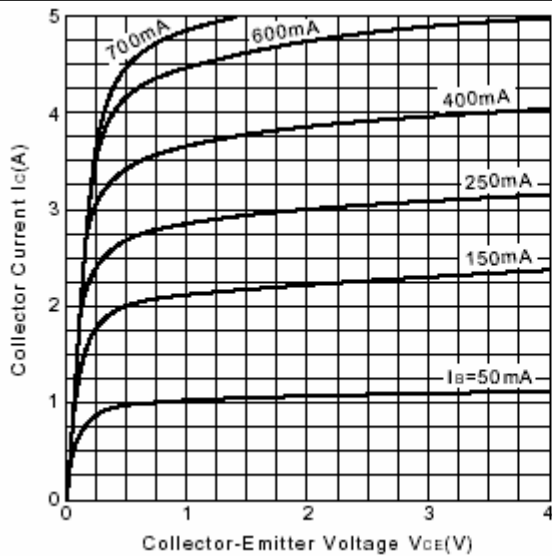

Fig.3 Static Characteristic

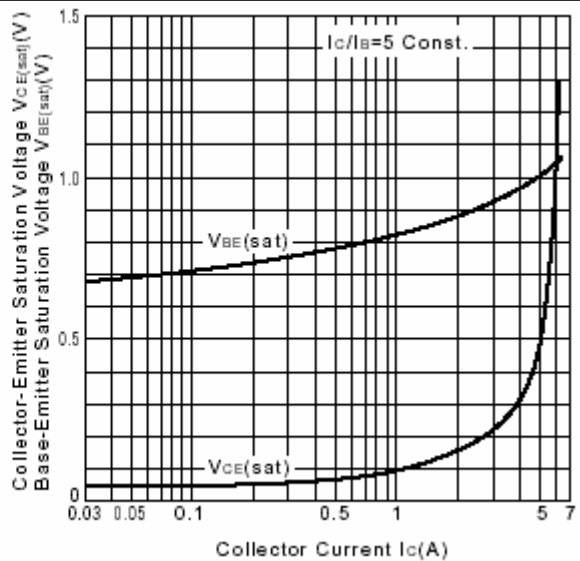

Fig.4 Base-Emitter Saturation Voltage
Collector-Emitter Saturation Voltage

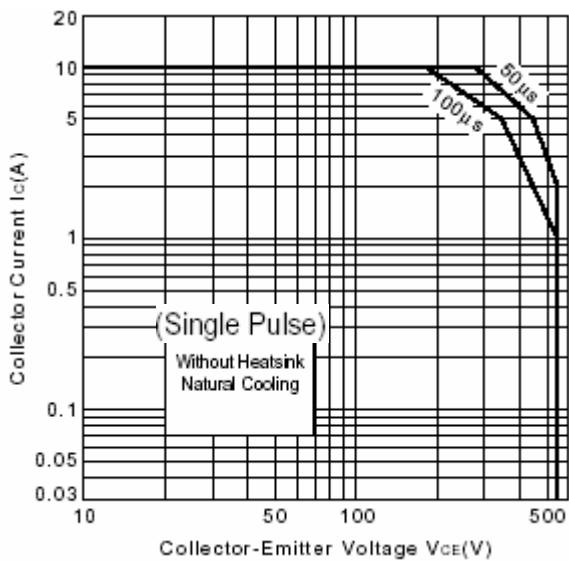

Fig.5 Safe Operating Area

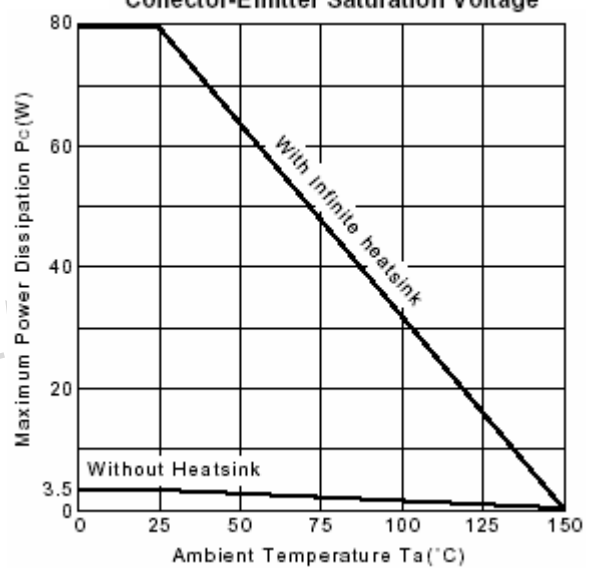

Fig.6 Power Derating

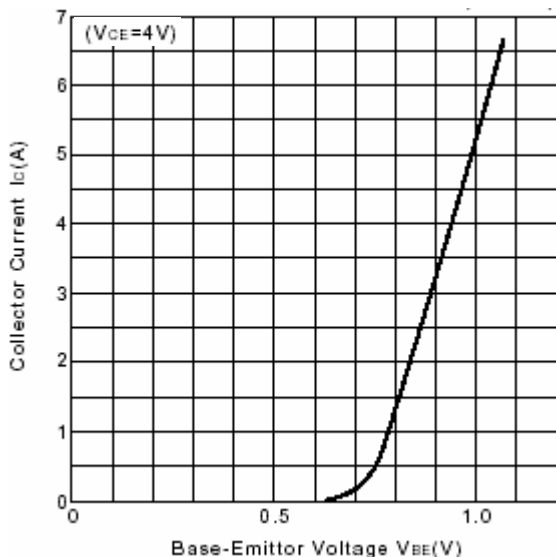

Fig.7 $I_c - V_{BE}$

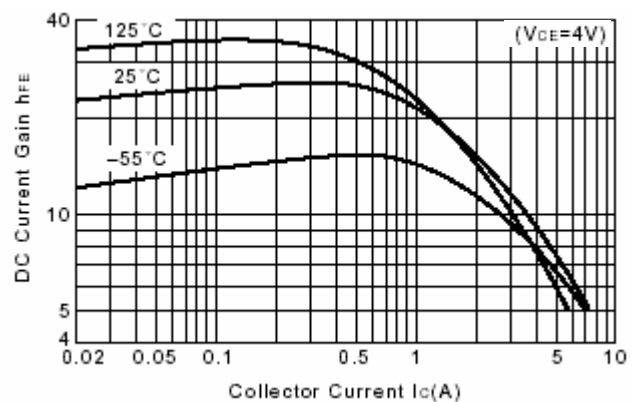

Fig.8 DC current Gain