

Silicon PNP Power Transistors

2SB824

DESCRIPTION

- With TO-220 package
- Low collector-emitter saturation voltage
- Complement to type 2SD1060

APPLICATIONS

- Suitable for relay drivers, high-speed Inverters, converters, and other general large-current switching applications

PINNING

PIN	DESCRIPTION
1	Emitter
2	Collector; connected to mounting base
3	Base

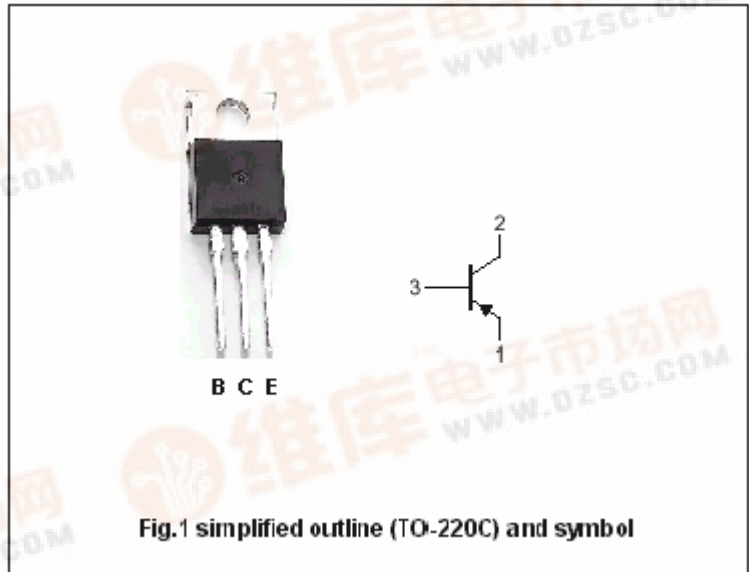

Absolute maximum ratings (Ta=25)

SYMBOL	PARAMETER	CONDITIONS	VALUE	UNIT
V _{CBO}	Collector-base voltage	Open emitter	-60	V
V _{CEO}	Collector-emitter voltage	Open base	-50	V
V _{EBO}	Emitter-base voltage	Open collector	-6	V
I _C	Collector current (DC)		-5	A
I _{CP}	Collector current (Pulse)		-9	A
P _C	Collector power dissipation	T _C =25	30	W
T _j	Junction temperature		150	
T _{stg}	Storage temperature		-55~150	

Silicon PNP Power Transistors

2SB824

CHARACTERISTICS

T_j=25 unless otherwise specified

SYMBOL	PARAMETER	CONDITIONS	MIN	TYP.	MAX	UNIT
V _{(BR)CEO}	Collector-emitter breakdown voltage	I _C =-1mA ; R _{BE} =	-50			V
V _{(BR)CBO}	Collector-base breakdown voltage	I _C =-1mA ; I _E =0	-60			V
V _{(BR)EBO}	Emitter-base breakdown voltage	I _E =-1mA ; I _C =0	-6			V
V _{CEsat}	Collector-emitter saturation voltage	I _C =-3A ; I _B =-0.3A			-0.4	V
I _{CBO}	Collector cut-off current	V _{CB} =-40V ; I _E =0			-0.1	mA
I _{EBO}	Emitter cut-off current	V _{EB} =-4V ; I _C =0			-0.1	mA
h _{FE-1}	DC current gain	I _C =-1A ; V _{CE} =-2V	70		280	
h _{FE-2}	DC current gain	I _C =-3A ; V _{CE} =-2V	30			
C _{OB}	Output capacitance	I _E =0 ; V _{CB} =-10V ; f=1MHz		160		pF
f _T	Transition frequency	I _C =-1A ; V _{CE} =-5V		30		MHz

Switching times

t _{on}	Turn-on time	I _C =-2.0A ; I _{B1} =- I _{B2} =-0.2A		0.1		μs
t _s	Storage time			0.7		μs
t _f	Fall time			0.2		μs

◆ h_{FE-1} classifications

Q	R	S
70-140	100-200	140-280

Silicon PNP Power Transistors

2SB824

PACKAGE OUTLINE

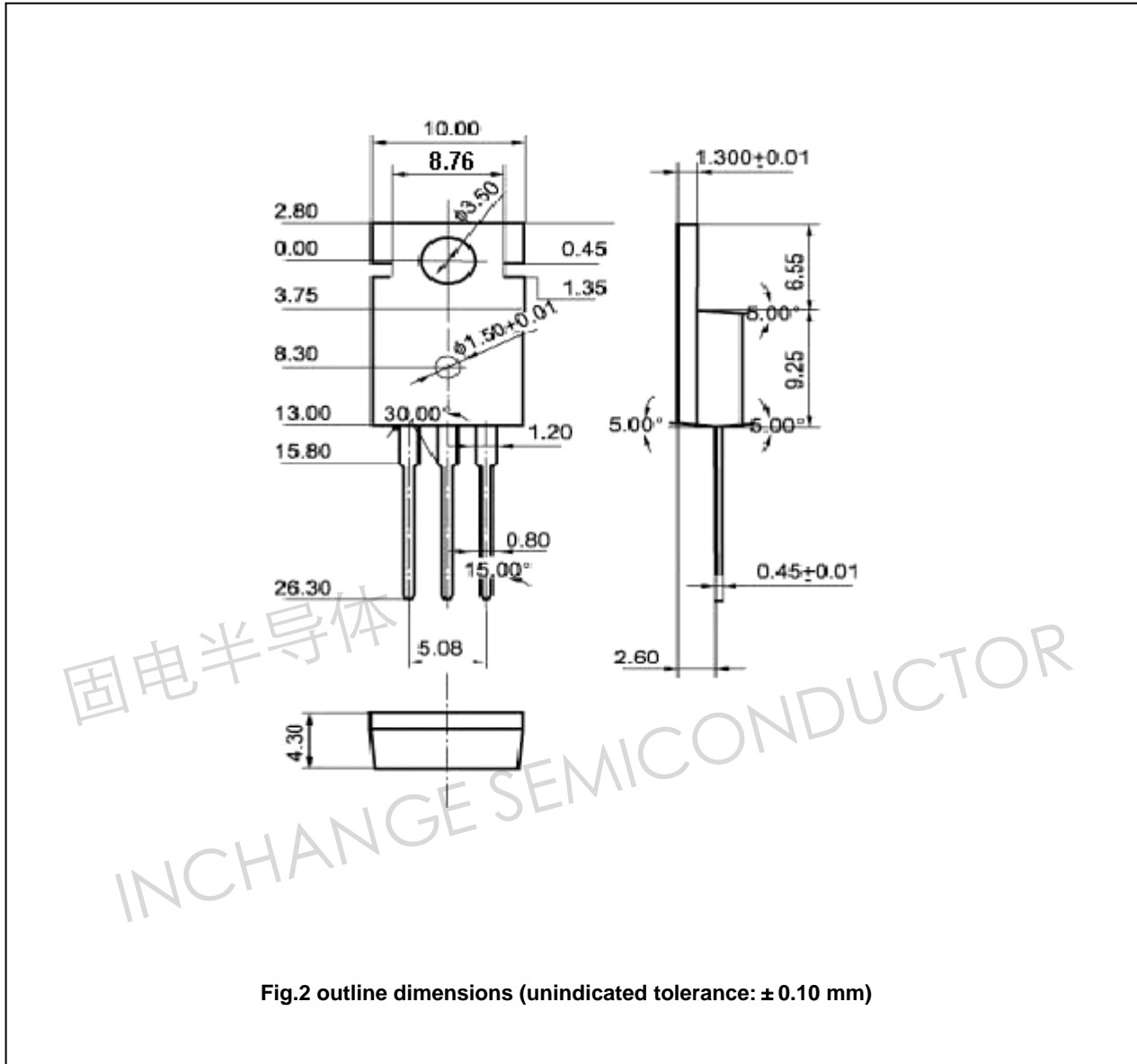

Silicon PNP Power Transistors

2SB824

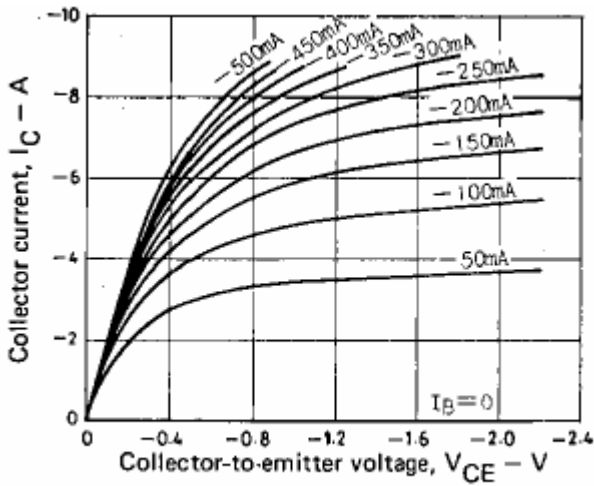

Fig.3 Static Characteristic

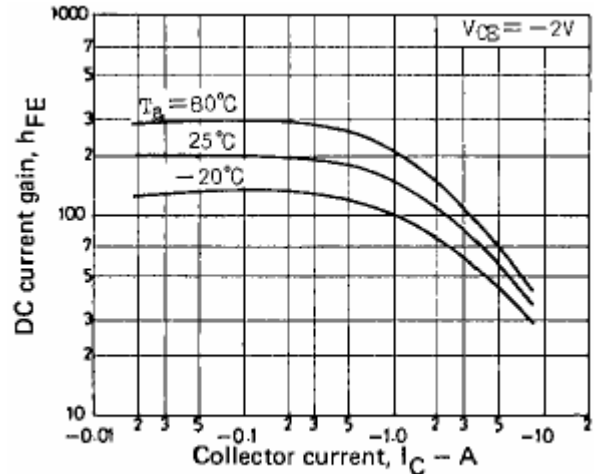

Fig.4 DC current Gain

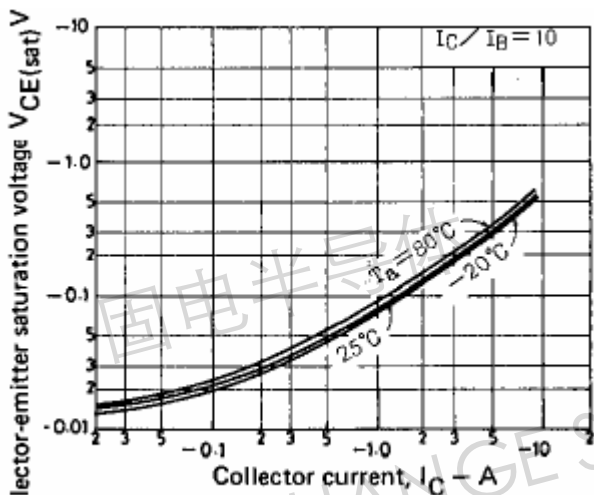

Fig.5 Collector-Emitter Saturation Voltage

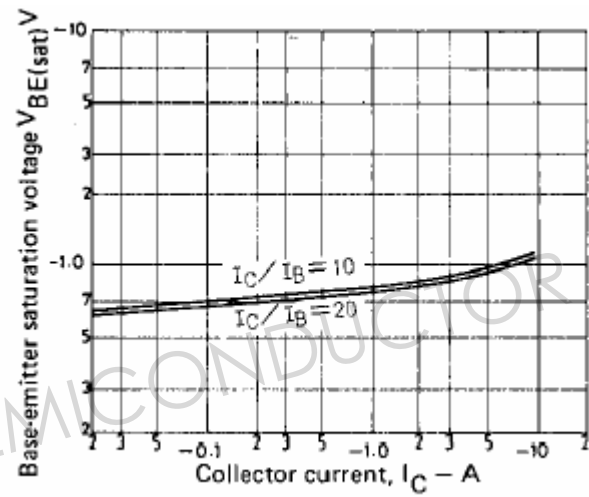

Fig.6 Base-Emitter Saturation Voltage

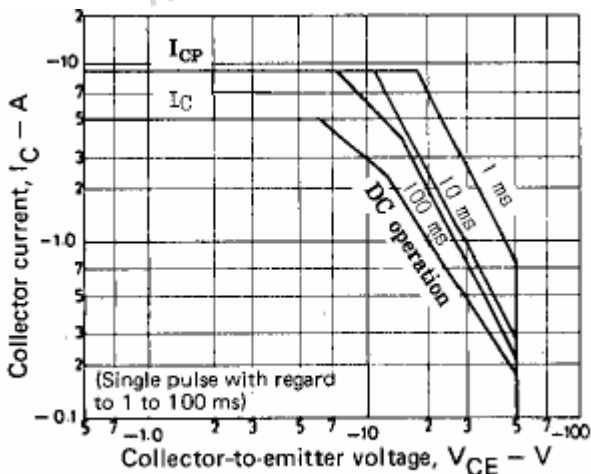

Fig.7 Safe Operating Area