

DC-DC CONVERTERS

POLA Non-isolated

1

NEW Product

- 15 A output current
- 5 V input voltage
- Wide-output voltage adjust (0.8 Vdc to 3.6 Vdc)
- Auto-track™ sequencing*
- Margin up/down controls
- Pre-bias start-up capability
- Efficiencies up to 95%
- Output ON/OFF inhibit
- Output voltage sense
- Point-of-Load-Alliance (POLA) compatible
- Available RoHS compliant

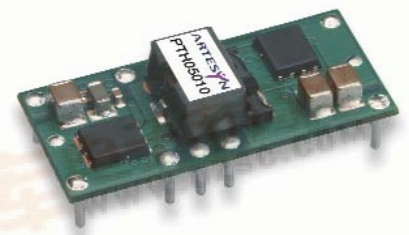

2 YEAR WARRANTY

The PTH05010 is a next generation series of non-isolated dc-dc converters offering some of the most advanced POL features available in the industry. The primary new feature provides for sequencing between multiple modules, a function, which is becoming a necessity for powering advanced silicon including DSP's, FPGA's and ASIC's requiring controlled power-up and power-down. Other industry leading features include margin up/down controls, pre-bias start-up capability and efficiencies up to 95%. The PTH05010 has an input voltage of 4.5 Vdc to 5.5 Vdc and offers a wide 0.8 Vdc to 3.6 Vdc output voltage range with up to 15 A output current, which allows for maximum design flexibility and a pathway for future upgrades.

All specifications are typical at nominal input, full load at 25 °C unless otherwise stated
C_{in} = 470 µF, C_{out} = 0 µF

SPECIFICATIONS

OUTPUT SPECIFICATIONS

Voltage adjustability	(See Note 4)	0.8-3.6 Vdc
Setpoint accuracy		±2.0% Vo
Line regulation		±10 mV typ.
Load regulation		±12 mV typ.
Total regulation		±3.0% Vo
Minimum load		0 A
Ripple and noise	20 MHz bandwidth	30 mV pk-pk
Temperature co-efficient	-40 °C to +85 °C	±0.5% Vo
Transient response (See Note 5)		70 µs recovery time Overshoot/undershoot 100 mV
Margin adjustment		±5.0% Vo

INPUT SPECIFICATIONS

Input voltage range	(See Note 3)	4.5-5.5 Vdc
Input current	No load	10 mA typ.
Remote ON/OFF	(See Note 1)	Positive logic
Start-up time		1 V/ms
Undervoltage lockout		3.7-4.3 V typ.
Track input voltage	Pin 8 (See Note 6, 7)	±0.3 Vin

EMC CHARACTERISTICS

Electrostatic discharge	EN61000-4-2, IEC801-2
Conducted immunity	EN61000-4-6
Radiated immunity	EN61000-4-3

GENERAL SPECIFICATIONS

Efficiency	(See Efficiency Table)	95% max.
Insulation voltage		Non-isolated
Switching frequency		275 kHz to 325 kHz
Approvals and standards		EN60950 UL/cUL60950
Material flammability		UL94V-0
Dimensions	(L x W x H)	34.80 x 15.75 x 9.00 mm 1.370 x 0.620 x 0.354 in
Weight		5 g (0.18 oz)
MTBF	Telcordia SR-332	7,092,000 hours

ENVIRONMENTAL SPECIFICATIONS

Thermal performance (See Note 2)	Operating ambient, temperature Non-operating	-40 °C to +85 °C -40 °C to +125 °C
MSL ('Z' suffix only)	JEDEC J-STD-020C	Level 3

PROTECTION

Short-circuit	Auto reset	27.5 A typ.
Thermal		Auto recovery

International Safety Standard Approvals

UL/cUL CAN/CSA-C22.2 No. 60950-1-03/UL 60950-1, File No. E174104

TÜV Product Service (EN60950) Certificate No. B 04 06 38572 044
CB Report and Certificate to IEC60950, Certificate No. IIS/R292/11

*Auto-track™ is a trade mark of Texas Instruments



OUTPUT POWER (MAX.)	INPUT VOLTAGE	OUTPUT VOLTAGE	OUTPUT CURRENT (MIN.)	OUTPUT CURRENT (MAX.)	EFFICIENCY (MAX.)	REGULATION		MODEL NUMBER ^(9,10)
						LINE	LOAD	
54 W	4.5-5.5 Vdc	0.8-3.6 Vdc	0 A	15 A	95%	±10 mV	±12 mV	PTH05010

Part Number System with Options

PTH05010WAST

Product Family
Point of Load Alliance Compatible

Input Voltage
05 = 5 V

Output Current
01 = 15 A

Mechanical Package
Always 0

Packaging Options

No Suffix = Trays
T = Tape and Reel ⁽⁸⁾

Mounting Option ⁽⁹⁾

D = Horizontal Through-Hole (Matte Sn)
H = Horizontal Through-Hole (Sn/Pb)
S = Surface-Mount (63/37 Sn/Pb pin solder material)
Z = Surface-Mount (96.5/3.0/0.5 Sn/Ag/Cu pin solder material)

Pin Option

A = Through-Hole Std. Pin Length (0.140")
A = Surface-Mount Tin/Lead Solder Ball

Output Voltage Code

W = Wide

Output Voltage Adjustment of the PTH05010 Series

The ultra-wide output voltage trim range offers major advantages to users who select the PTH05010. It is no longer necessary to purchase a variety of modules in order to cover different output voltages. The output voltage can be trimmed in a range of 0.8 Vdc to 3.6 Vdc. When the PTH05010 converter leaves the factory the output has been adjusted to the default voltage of 0.8 V.

Notes

- Remote ON/OFF. Positive Logic
ON: Pin 3 open; or $V > V_{in} - 0.5 V$
OFF: Pin 3 GND; or $V < 0.8 V$ (min - 0.2 V).
- See Figures 1 and 2 for safe operating curves.
- A 470 μF electrolytic input capacitor is required for proper operation. The capacitor must be rated for a minimum of 700 mA rms of ripple current.
- An external output capacitor is not required for basic operation. Adding 33 μF of distributed capacitance at the load will improve the transient response.
- 1 A/ μs load step, 50 to 100% $I_{o,max}$, $C_{out} = 330 \mu F$.
- If utilized V_{out} will track applied voltage by $\pm 0.3 V$ (up to V_o set point).
- The pre-bias start-up feature is not compatible with Auto-Track™. This is because when the module is under Auto-Track™ control, it is fully active and will sink current if the output voltage is below that of a back-feeding source. Therefore to ensure a pre-bias hold-off, one of the following two techniques must be followed when input power is first applied to the module. The Auto-Track™ function must either be disabled, or the module's output held off using the Inhibit pin. Refer to Application Note 155 for more details.
- Tape and reel packaging only available on the surface-mount versions.
- To order Pb-free (RoHS compatible) surface-mount parts replace the mounting option 'S' with 'Z', e.g. PTH05010WAZ. To order Pb-free (RoHS compatible) through-hole parts replace the mounting option 'H' with 'D', e.g. PTH05010WAD.
- NOTICE: Some models do not support all options. Please contact your local Artesyn representative or use the on-line model number search tool at <http://www.artesyn.com/powergroup/products.htm> to find a suitable

EFFICIENCY TABLE ($I_o = 10 A$)

OUTPUT VOLTAGE	EFFICIENCY
$V_o = 1.0 V$	86%
$V_o = 1.2 V$	88%
$V_o = 1.5 V$	90%
$V_o = 1.8 V$	91%
$V_o = 2.0 V$	92%
$V_o = 2.5 V$	93%
$V_o = 3.3 V$	95%

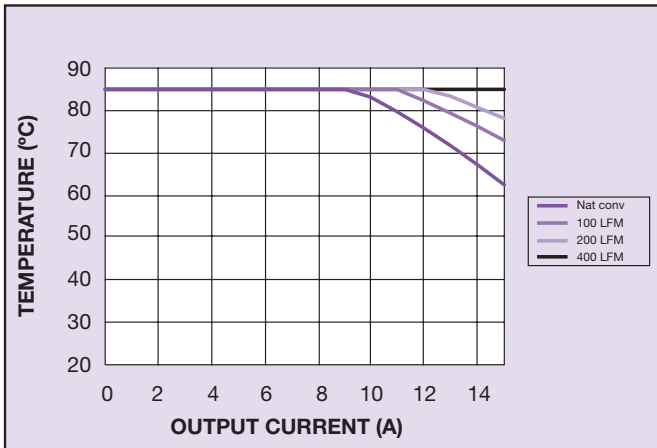

Figure 1 - Safe Operating Area
Vin = 5 V, Output Voltage = 3.3 V (See Note A)

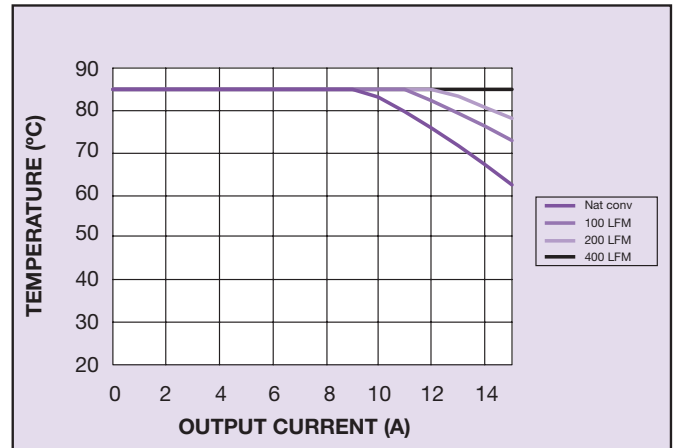

Figure 2 - Safe Operating Area
Vin = 5 V, Output Voltage = 1.0 V (See Note A)

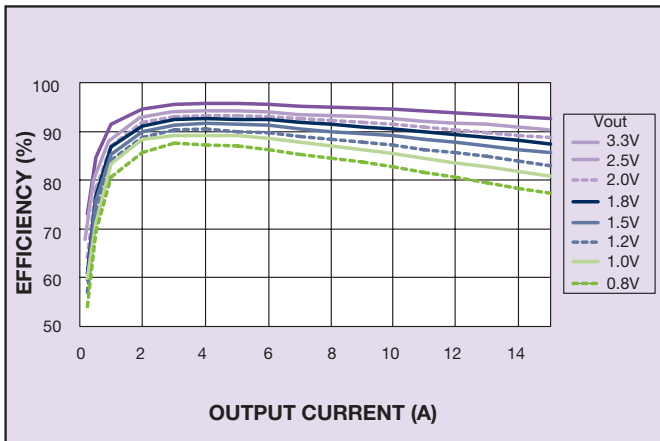

Figure 3 - Efficiency vs Load Current
Vin = 5 V (See Note B)

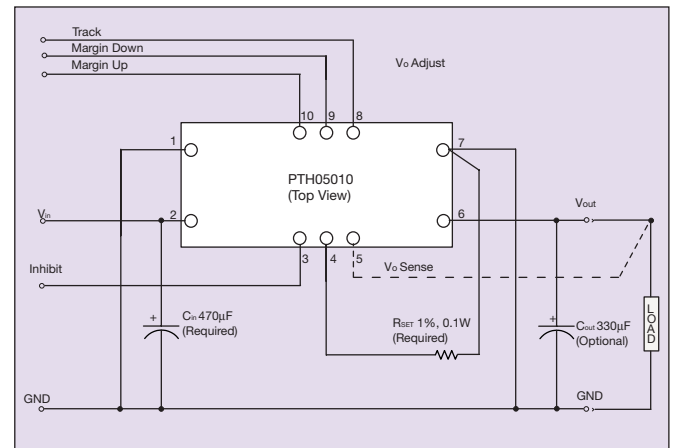

Figure 4 - Standard Application

Notes

- A** SOA curves represent the conditions at which internal components are within the Artesyn derating guidelines.
- B** Characteristic data has been developed from actual products tested at 25 °C. This data is considered typical data for the converter.

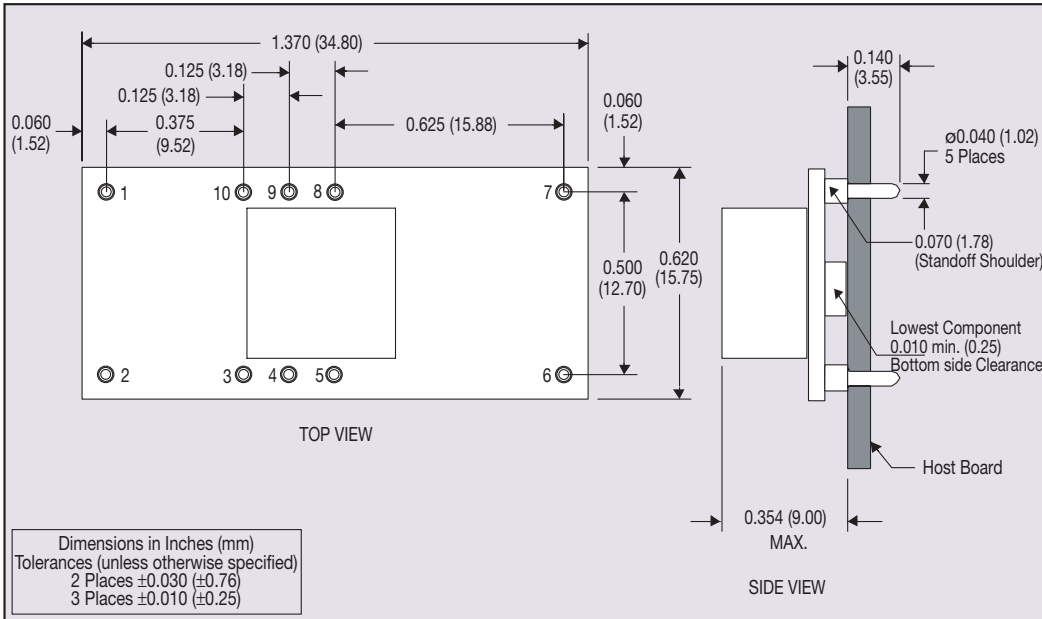

Figure 5 - Plated Through-Hole Mechanical Drawing

PIN CONNECTIONS	
PIN NO.	FUNCTION
1	Ground
2	Vin
3	Inhibit*
4	Vo adjust
5	Vo sense
6	Vout
7	Ground
8	Track
9	Margin down*
10	Margin up*

*Denotes negative logic:
Open = Normal operation
Ground = Function active

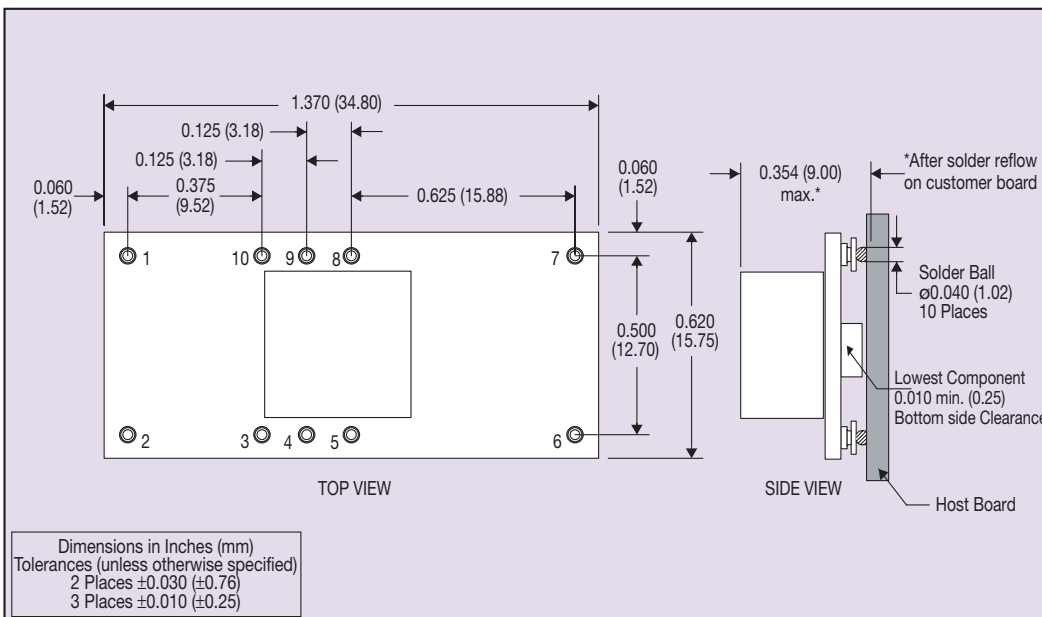

Figure 6 - Surface-Mount Mechanical Drawing