

Inchange Semiconductor

Product Specification

Silicon NPN Power Transistors

2SC3451

DESCRIPTION

- With TO-3PN package
- High breakdown voltage and high reliability.
- Fast switching speed
- Wide area of safe operation

APPLICATIONS

- 500V/15A Switching Regulator Applications

PINNING

PIN	DESCRIPTION
1	Base
2	Collector;connected to mounting base
3	Emitter

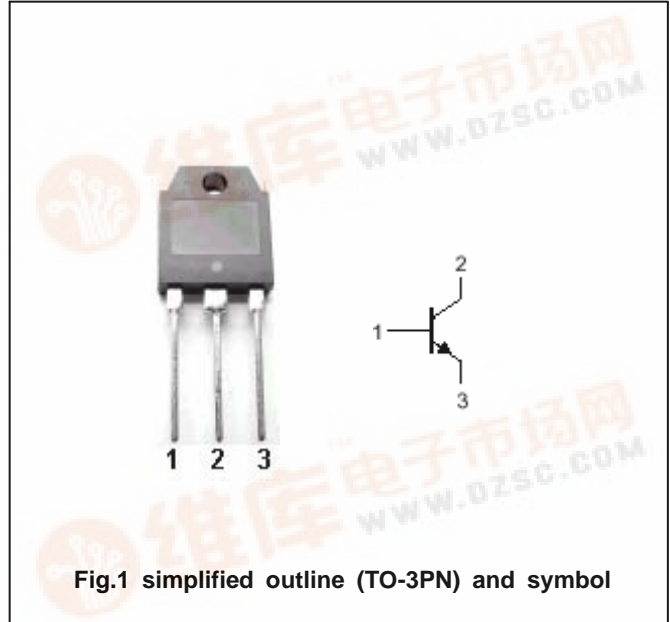

Fig.1 simplified outline (TO-3PN) and symbol

Absolute maximum ratings(Ta=)

SYMBOL	PARAMETER	CONDITIONS	VALUE	UNIT
V _{CBO}	Collector-base voltage	Open emitter	800	V
V _{CEO}	Collector-emitter voltage	Open base	500	V
V _{EBO}	Emitter-base voltage	Open collector	7	V
I _C	Collector current		15	A
I _{CM}	Collector current-peak		25	A
I _B	Base current		4	A
P _C	Collector power dissipation	T _C =25	100	W
T _j	Junction temperature		150	
T _{stg}	Storage temperature		-55~150	

Silicon NPN Power Transistors

2SC3451

CHARACTERISTICS

T_j=25 unless otherwise specified

SYMBOL	PARAMETER	CONDITIONS	MIN	TYP.	MAX	UNIT
V _{(BR)CEO}	Collector-emitter breakdown voltage	I _C =5mA ; R _{BE} =	500			V
V _{(BR)CBO}	Collector-base breakdown voltage	I _C =1mA ; I _E =0	800			V
V _{(BR)EBO}	Emitter-base breakdown voltage	I _E =1mA ; I _C =0	7			V
V _{CEsat}	Collector-emitter saturation voltage	I _C =6A ; I _B =1.2A			1.0	V
V _{BEsat}	Base-emitter saturation voltage	I _C =6A ; I _B =1.2A			1.5	V
I _{CBO}	Collector cut-off current	V _{CB} =500V ; I _E =0			10	μA
I _{EBO}	Emitter cut-off current	V _{EB} =5V ; I _C =0			10	μA
h _{FE-1}	DC current gain	I _C =1.2A ; V _{CE} =5V	15		50	
h _{FE-2}	DC current gain	I _C =6A ; V _{CE} =5V	8			
C _{ob}	Output capacitance	I _E =0 ; V _{CB} =10V ; f=1MHz		160		pF
f _T	Transition frequency	I _C =1.2A ; V _{CE} =10V		18		MHz

Switching times

t _{on}	Turn-on time	I _C =7A ; R _L =28.6 I _{B1} =1.4A ; I _{B2} =-2.8A V _{CC} =200V			0.5	μs
t _{stg}	Storage time				3.0	μs
t _f	Fall time				0.3	μs

◆ h_{FE-1} Classifications

L	M	N
15-30	20-40	30-50

Silicon NPN Power Transistors

2SC3451

PACKAGE OUTLINE

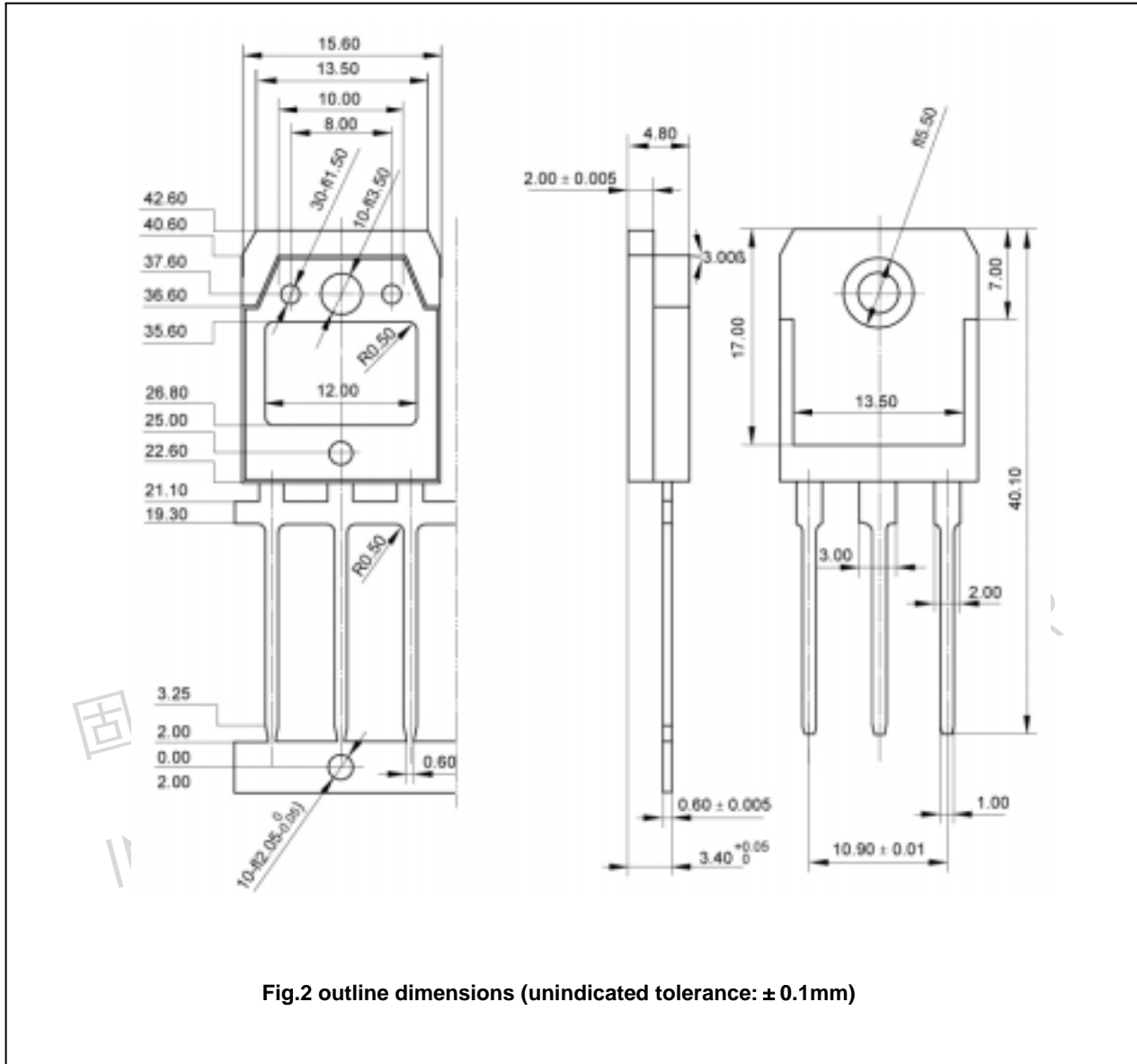

Silicon NPN Power Transistors

2SC3451

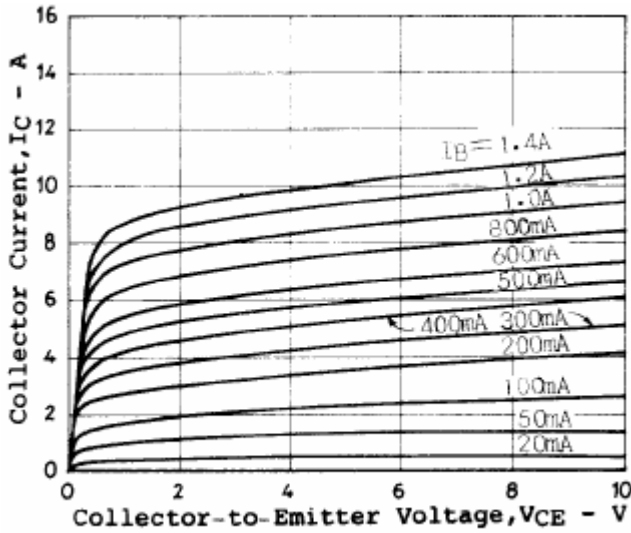

Fig.3 Static Characteristic

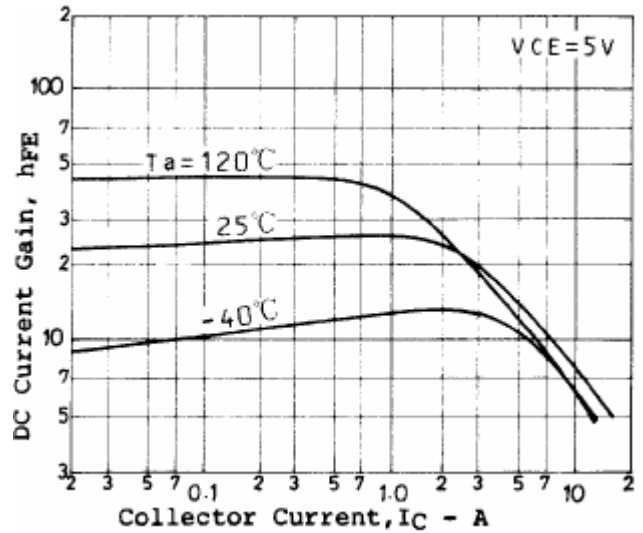

Fig.4 DC current Gain

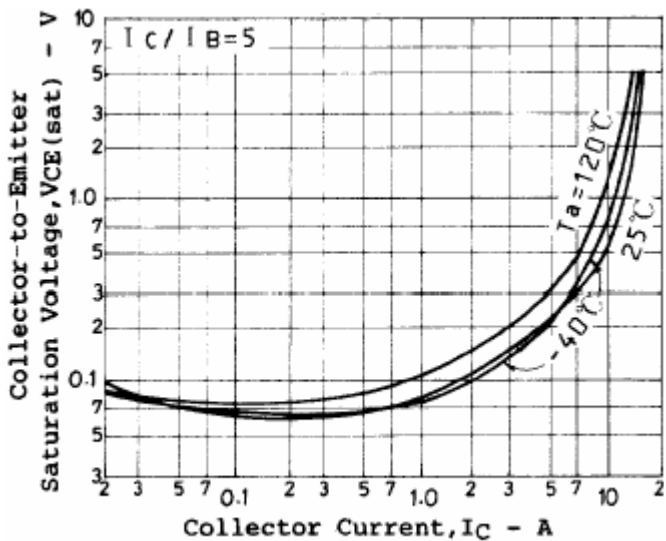

Fig.5 Collector-Emmitter Saturation Voltage

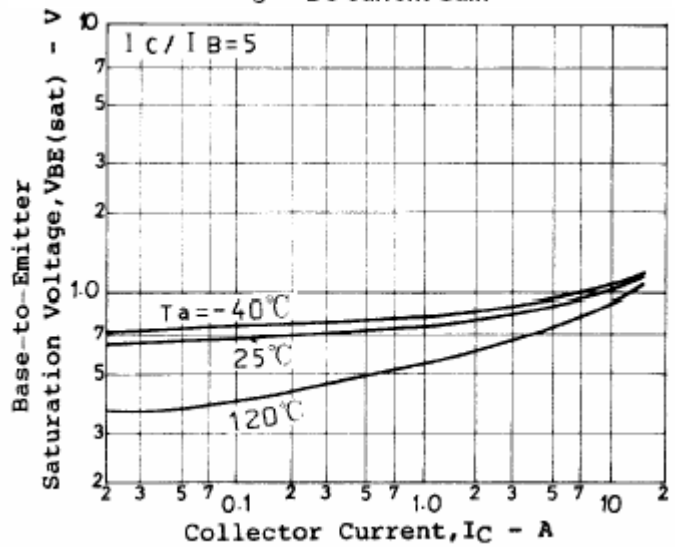

Fig.6 Base-Emmitter Saturation Voltage

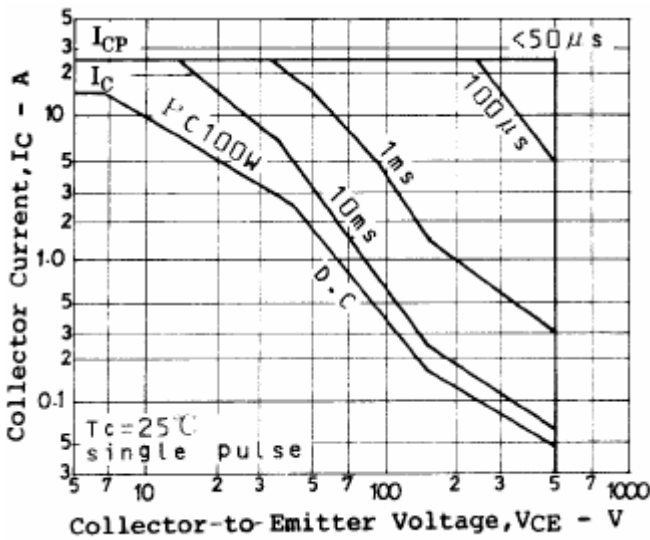

Fig.7 Safe Operating Area