

- **2.5-V Virtual Ground for 5-V/GND Analog Systems**
- **High Output-Current Capability Sink or Source . . . 20 mA Typ**
- **Micropower Operation . . . 170 μ A Typ**
- **Excellent Regulation Characteristics**
 - **Output Regulation**
 - 45 μ V Typ at $I_O = 0$ to –10 mA
 - +15 μ V Typ at $I_O = 0$ to +10 mA
 - **Input Regulation = 1.5 μ V/V Typ**
- **Low-Impedance Output . . . 0.0075 Ω Typ**
- **Macromodel Included**

description

In signal-conditioning applications using a single power source, a reference voltage is required for termination of all signal grounds. To accomplish this, engineers have typically used solutions consisting of resistors, capacitors, operational amplifiers, and voltage references. Texas Instruments has eliminated all of those components with one easy-to-use 3-terminal device. That device is the TLE2425 precision virtual ground.

Use of the TLE2425 over other typical circuit solutions gives the designer increased dynamic signal range, improved signal-to-noise ratio, lower distortion, improved signal accuracy, and easier interfacing to ADCs and DACs. These benefits are the result of combining a precision micropower voltage reference and a high-performance precision operational amplifier in a single silicon chip. It is the precision and performance of these two circuit functions together that yield such dramatic system-level performance.

The TLE2425 improves input regulation as well as output regulation and, in addition, reduces output impedance and power dissipation in a majority of virtual-ground-generation circuits. Both input regulation and load regulation exceed 12 bits of accuracy on a single 5-V system. Signal-conditioning front ends of data acquisition systems that push 12 bits and beyond can use the TLE2425 to eliminate a major source of system error.

OUTPUT REGULATION

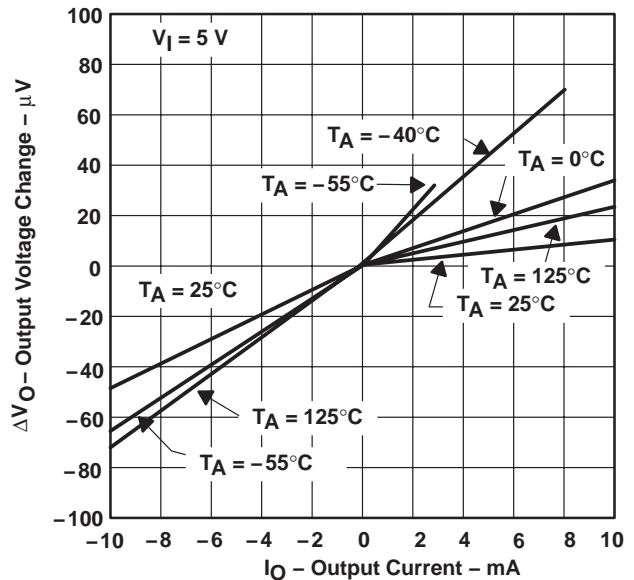

AVAILABLE OPTIONS

T _A	SMALL OUTLINE (D)	PLASTIC TO-226AA (LP)
0°C to 70°C	TLE2425CD	TLE2425CD
–40°C to 85°C	TLE2425ID	TLE2425ID
–55°C to 125°C	TLE2425MD	—

† The D package is available taped and reeled. Add R suffix to the device type (e.g., TLE2425CDR).



Please be aware that an important notice concerning availability, standard warranty, and use in critical applications of Texas Instruments semiconductor products and disclaimers thereto appears at the end of this data sheet.

PRODUCTION DATA information is current as of publication date. Products conform to specifications per the terms of Texas Instruments standard warranty. Production processing does not necessarily include testing of all parameters.



TLE2425 PRECISION VIRTUAL GROUND

SLOS065D – MARCH 1991 – REVISED APRIL 2002

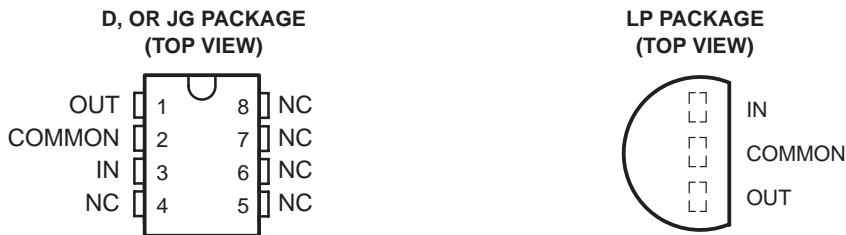

NC – No internal connection

absolute maximum ratings over operating free-air temperature range (unless otherwise noted)†

Continuous input voltage, V_I	40 V
Output current, I_O	±80 mA
Duration of short-circuit current at (or below) 25°C (see Note 1)	unlimited
Continuous total power dissipation	See Dissipation Rating Table
Operating free-air temperature range, T_A :	
C-suffix	0°C to 70°C
I-suffix	–40°C to 85°C
M-suffix	–55°C to 125°C
Storage temperature range, T_{stg}	–65°C to 150°C
Lead temperature 1,6 mm (1/16 inch) from case for 10 seconds: D package	260°C
Lead temperature 1,6 mm (1/16 inch) from case for 60 seconds: JG or LP package	300°C

† Stresses beyond those listed under “absolute maximum ratings” may cause permanent damage to the device. These are stress ratings only, and functional operation of the device at these or any other conditions beyond those indicated under “recommended operating conditions” is not implied. Exposure to absolute-maximum-rated conditions for extended periods may affect device reliability.

NOTE 1: The output may be shorted to either supply. Temperature and/or supply voltages must be limited to ensure that the maximum dissipation rating is not exceeded.

DISSIPATION RATING TABLE

PACKAGE	$T_A \leq 25^\circ\text{C}$	DERATING FACTOR	$T_A = 70^\circ\text{C}$	$T_A = 85^\circ\text{C}$	$T_A = 125^\circ\text{C}$
	POWER RATING	ABOVE $T_A = 25^\circ\text{C}$	POWER RATING	POWER RATING	POWER RATING
D	725 mW	5.8 mW/°C	464 mW	377 mW	145 mW
JG	1050 mW	8.4 mW/°C	672 mW	546 mW	210 mW
LP	775 mW	6.2 mW/°C	496 mW	403 mW	155 mW

recommended operating conditions

	C-SUFFIX		I-SUFFIX		M-SUFFIX		UNIT
	MIN	MAX	MIN	MAX	MIN	MAX	
Input voltage, V_I	4	40	4	40	4	40	V
Operating free-air temperature, T_A	0	70	–40	85	–55	125	°C



electrical characteristics at specified free-air temperature, $V_I = 5\text{ V}$, $I_O = 0$ (unless otherwise noted)

PARAMETER	TEST CONDITIONS	T_A †	TLE2425C			UNIT
			MIN	TYP	MAX	
Output voltage		25°C	2.48	2.5	2.52	V
		Full range	2.47		2.53	
Temperature coefficient of output voltage		25°C		20		ppm/°C
Bias current	$I_O = 0$	25°C		170	250	μA
		Full range			250	
Input voltage regulation	$V_I = 4.5\text{ V to }5.5\text{ V}$	25°C		1.5	20	μV
		Full range			25	
	$V_I = 4\text{ V to }40\text{ V}$	25°C		1.5	20	μV/V
		Full range			25	
Ripple rejection	$f = 120\text{ Hz}$, $\Delta V_I(\text{PP}) = 1\text{ V}$	25°C		80		dB
Output voltage regulation (source current)‡	$I_O = 0\text{ to }-10\text{ mA}$	25°C	-160	-45	160	μV
	Full range		-250		250	
Output voltage regulation (sink current)‡	$I_O = 0\text{ to }10\text{ mA}$	25°C	-160	15	160	μV
	Full range		-250		250	
	$I_O = 0\text{ to }20\text{ mA}$	25°C	-235	65	235	
Long-term drift of output voltage	$\Delta t = 1000\text{ h}$, Noncumulative	25°C		15		ppm
Output impedance		25°C		7.5	22.5	mΩ
Short-circuit output current (sink current)	$V_O = 5\text{ V}$	25°C	30	55		mA
Short-circuit output current (source current)	$V_O = 0$		-30	-50		
Output noise voltage, rms	$f = 10\text{ Hz to }10\text{ kHz}$	25°C		100		μV
Output voltage response to output current step	V_O to 0.1%, $I_O = \pm 10\text{ mA}$	25°C	$C_L = 0$		110	μs
			$C_L = 100\text{ pF}$		115	
	V_O to 0.01%, $I_O = \pm 10\text{ mA}$	$C_L = 0$		180		
		$C_L = 100\text{ pF}$		180		
Output voltage response to input voltage step	$V_I = 4.5\text{ to }5.5\text{ V}$, V_O to 0.1%	25°C		12		μs
	$V_I = 4.5\text{ to }5.5\text{ V}$, V_O to 0.01%			30		
Output voltage turn-on response	$V_I = 0\text{ to }5\text{ V}$, V_O to 0.1%	25°C		125		μs
	$V_I = 0\text{ to }5\text{ V}$, V_O to 0.01%			210		

† Full range is 0°C to 70°C.

‡ The listed values are not production tested.

TLE2425 PRECISION VIRTUAL GROUND

SLOS065D – MARCH 1991 – REVISED APRIL 2002

electrical characteristics at specified free-air temperature, $V_I = 5\text{ V}$, $I_O = 0$ (unless otherwise noted)

PARAMETER	TEST CONDITIONS	T_A †	TLE2425I			UNIT
			MIN	TYP	MAX	
Output voltage		25°C	2.48	2.5	2.52	V
		Full range	2.47		2.53	
Temperature coefficient of output voltage		25°C	20			ppm/°C
Bias current	$I_O = 0$	25°C	170	250		μA
		Full range		250		
Input voltage regulation	$V_I = 4.5\text{ V to }5.5\text{ V}$	25°C	1.5	20		μV
		Full range		75		
	$V_I = 4\text{ V to }40\text{ V}$	25°C	1.5	20		μV/V
		Full range		75		
Ripple rejection	$f = 120\text{ Hz}$, $\Delta V_I(\text{PP}) = 1\text{ V}$	25°C	80			dB
Output voltage regulation (source current)‡	$I_O = 0\text{ to }-10\text{ mA}$	25°C	-160	-45	160	μV
		Full range	-250		250	
Output voltage regulation (sink current)‡	$I_O = 0\text{ to }-20\text{ mA}$	25°C	-450	-150	450	μV
		Full range	-250		250	
Output voltage regulation (sink current)‡	$I_O = 0\text{ to }8\text{ mA}$	25°C	-160	15	160	μV
		Full range	-250		250	
Output voltage regulation (sink current)‡	$I_O = 0\text{ to }20\text{ mA}$	25°C	-235	65	235	μV
		Full range	-235		235	
Long-term drift of output voltage	$\Delta t = 1000\text{ h}$, Noncumulative	25°C	15			ppm
Output impedance		25°C	7.5	22.5		mΩ
Short-circuit output current (sink current)	$V_O = 5\text{ V}$	25°C	30	55		mA
Short-circuit output current (source current)	$V_O = 0$		-30	-50		
Output noise voltage, rms	$f = 10\text{ Hz to }10\text{ kHz}$	25°C	100			μV
Output voltage response to output current step	$V_O\text{ to }0.1\%$, $I_O = \pm 10\text{ mA}$	25°C	$C_L = 0$	110		μs
			$C_L = 100\text{ pF}$	115		
	$V_O\text{ to }0.01\%$, $I_O = \pm 10\text{ mA}$	$C_L = 0$	180			
		$C_L = 100\text{ pF}$	180			
Output voltage response to input voltage step	$V_I = 4.5\text{ to }5.5\text{ V}$, $V_O\text{ to }0.1\%$	25°C	12			μs
	$V_I = 4.5\text{ to }5.5\text{ V}$, $V_O\text{ to }0.01\%$		30			
Output voltage turn-on response	$V_I = 0\text{ to }5\text{ V}$, $V_O\text{ to }0.1\%$	25°C	125			μs
	$V_I = 0\text{ to }5\text{ V}$, $V_O\text{ to }0.01\%$		210			

† Full range is -40°C to 85°C.

‡ The listed values are not production tested.



electrical characteristics at specified free-air temperature, $V_I = 5\text{ V}$, $I_O = 0$ (unless otherwise noted)

PARAMETER	TEST CONDITIONS	T_A †	TLE2425M			UNIT
			MIN	TYP	MAX	
Output voltage		25°C	2.48	2.5	2.52	V
		Full range	2.47		2.53	
Temperature coefficient of output voltage		25°C	20			ppm/°C
Bias current	$I_O = 0$	25°C	170	250		μA
		Full range		250		
Input voltage regulation	$V_I = 4.5\text{ V to }5.5\text{ V}$	25°C	1.5	20		μV
		Full range		100		
	$V_I = 4.5\text{ V to }40\text{ V}$	25°C	1.5	20		μV/V
		Full range		100		
Ripple rejection	$f = 120\text{ Hz}$, $\Delta V_I(\text{PP}) = 1\text{ V}$	25°C	80			dB
Output voltage regulation (source current)‡	$I_O = 0\text{ to }-10\text{ mA}$	25°C	-160	-45	160	μV
	Full range		-250		250	
Output voltage regulation (sink current)‡	$I_O = 0\text{ to }-20\text{ mA}$	25°C	-450	-150	450	μV
	$I_O = 0\text{ to }3\text{ mA}$	25°C	-160	15	160	
Output voltage regulation (sink current)‡	$I_O = 0\text{ to }20\text{ mA}$	25°C	-235	65	235	μV
	Full range		-250		250	
Long-term drift of output voltage	$\Delta t = 1000\text{ h}$, Noncumulative	25°C	15			ppm
Output impedance		25°C	7.5	22.5		mΩ
Short-circuit output current (sink current)	$V_O = 5\text{ V}$	25°C	30	55		mA
Short-circuit output current (source current)	$V_O = 0$		-30	-50		
Output noise voltage, rms	$f = 10\text{ Hz to }10\text{ kHz}$	25°C	100			μV
Output voltage response to output current step	$V_O\text{ to }0.1\%$, $I_O = \pm 10\text{ mA}$	25°C	$C_L = 0$	110		μs
			$C_L = 100\text{ pF}$	115		
	$V_O\text{ to }0.01\%$, $I_O = \pm 10\text{ mA}$	$C_L = 0$	180			
		$C_L = 100\text{ pF}$	180			
Output voltage response to input voltage step	$V_I = 4.5\text{ to }5.5\text{ V}$, $V_O\text{ to }0.1\%$	25°C	12			μs
	$V_I = 4.5\text{ to }5.5\text{ V}$, $V_O\text{ to }0.01\%$		30			
Output voltage turn-on response	$V_I = 0\text{ to }5\text{ V}$, $V_O\text{ to }0.1\%$	25°C	125			μs
	$V_I = 0\text{ to }5\text{ V}$, $V_O\text{ to }0.01\%$		210			

† Full range is -55°C to 125°C.

‡ The listed values are not production tested.

TLE2425 PRECISION VIRTUAL GROUND

SLOS065D – MARCH 1991 – REVISED APRIL 2002

TYPICAL CHARACTERISTICS

Table Of Graphs

		FIGURE
Output voltage	Distribution	1
	vs Free-air temperature	2
Output voltage hysteresis	vs Free-air temperature	3
Input bias current	vs Input voltage	4
	vs Free-air temperature	5
Input voltage regulation		6
Ripple rejection	vs Frequency	7
Output voltage regulation		8
Output impedance	vs Frequency	9
Short-circuit output current	vs Free-air temperature	10
Spectral noise voltage density	vs Frequency	11
Wide-band noise voltage	vs Frequency	12
Output voltage change with current step	vs Time	13
Output voltage change with voltage step	vs Time	14
Output voltage power-up response	vs Time	15
Output current	vs Load capacitance	16



TYPICAL CHARACTERISTICS†

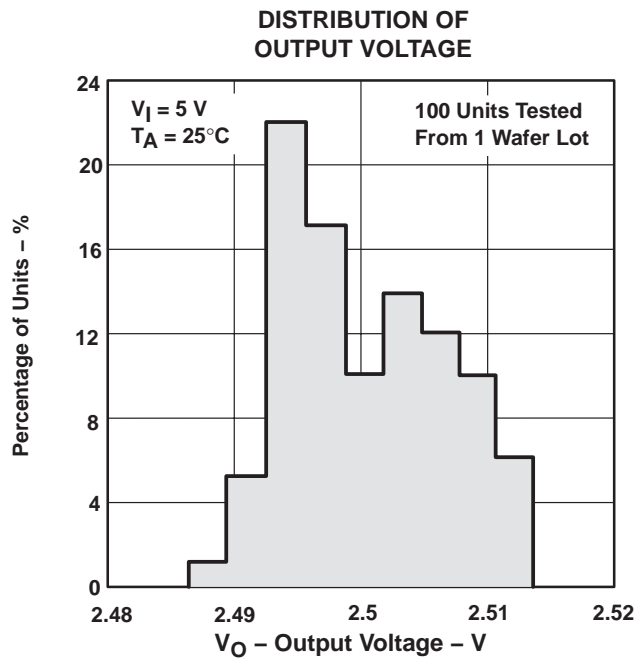

Figure 1

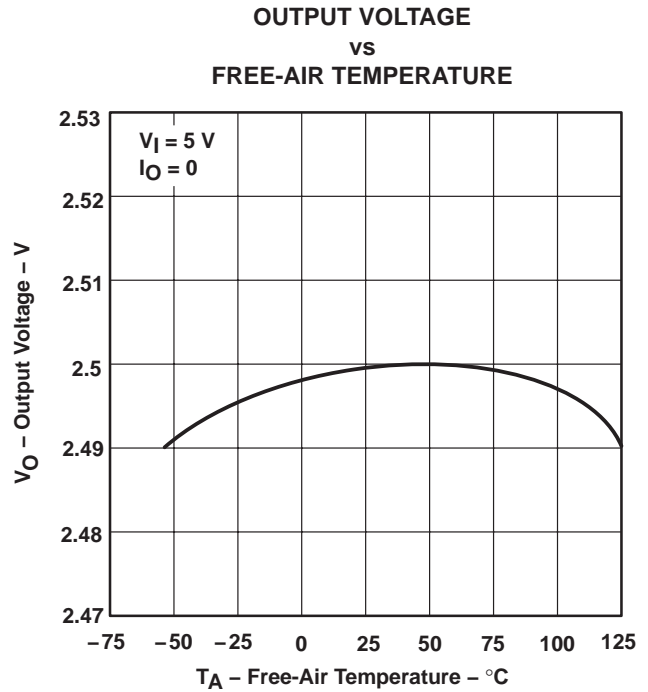

Figure 2

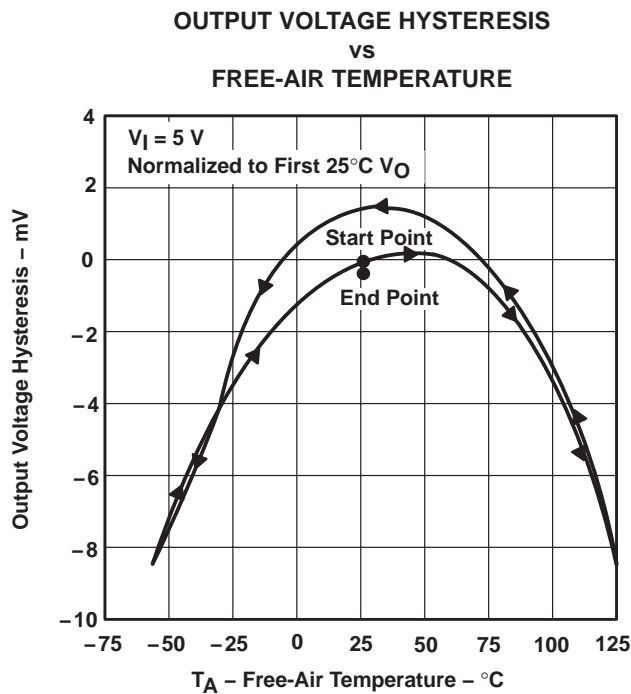

Figure 3

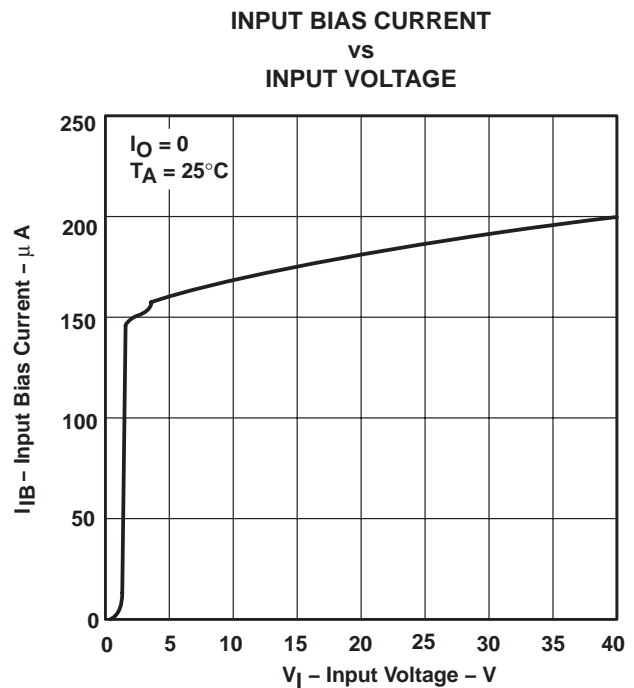

Figure 4

† Data at high and low temperatures are applicable within rated operating free-air temperature ranges of the various devices.

TLE2425 PRECISION VIRTUAL GROUND

SLOS065D – MARCH 1991 – REVISED APRIL 2002

TYPICAL CHARACTERISTICS†

**INPUT BIAS CURRENT
vs
FREE-AIR TEMPERATURE**

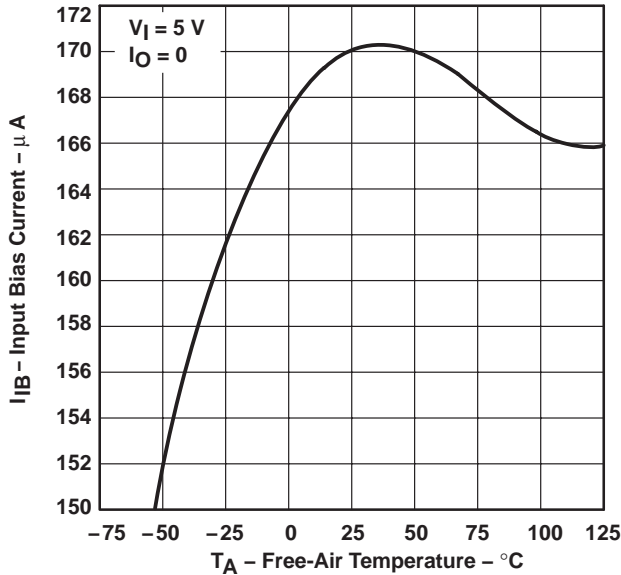

Figure 5

INPUT VOLTAGE REGULATION

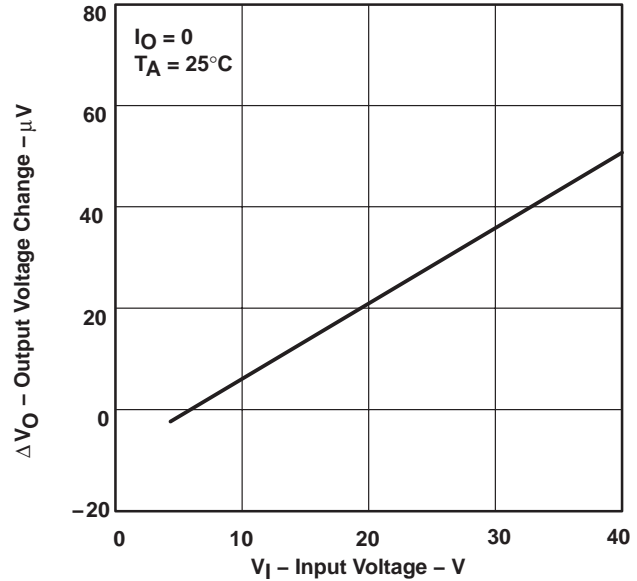

Figure 6

**RIPPLE REJECTION
vs
FREQUENCY**

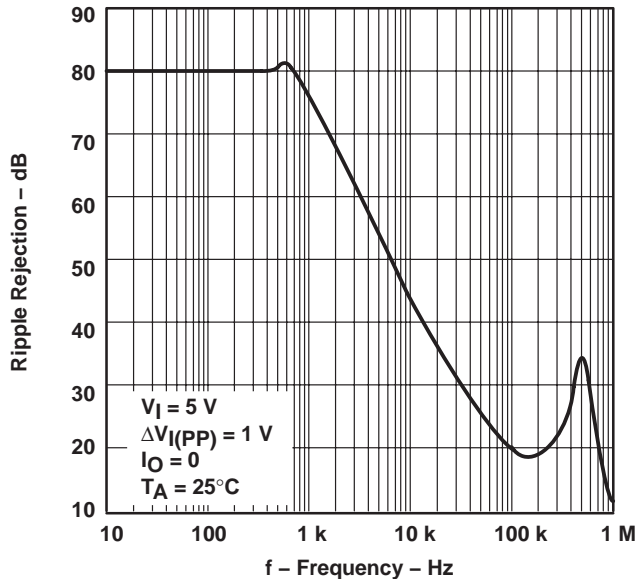

Figure 7

OUTPUT VOLTAGE REGULATION

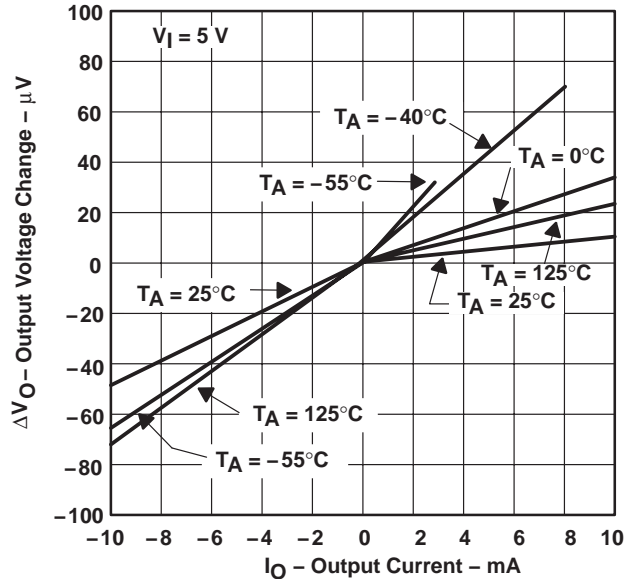

Figure 8

† Data at high and low temperatures are applicable within rated operating free-air temperature ranges of the various devices.

TYPICAL CHARACTERISTICS

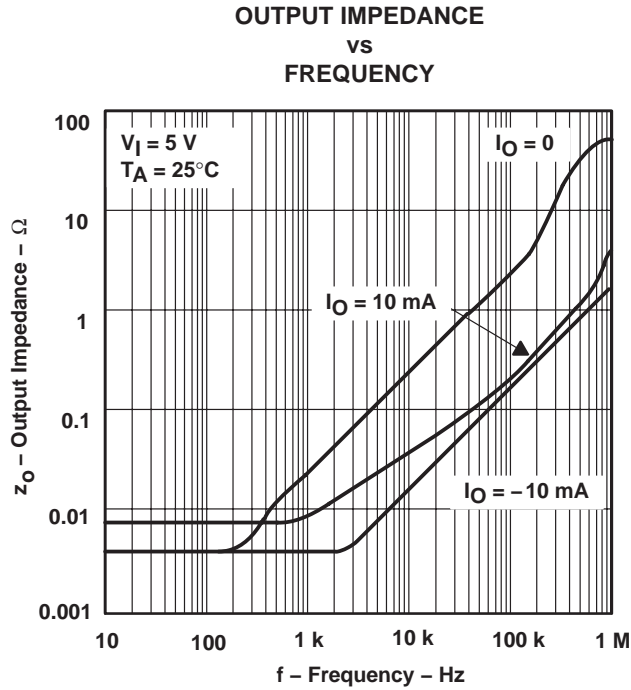

Figure 9

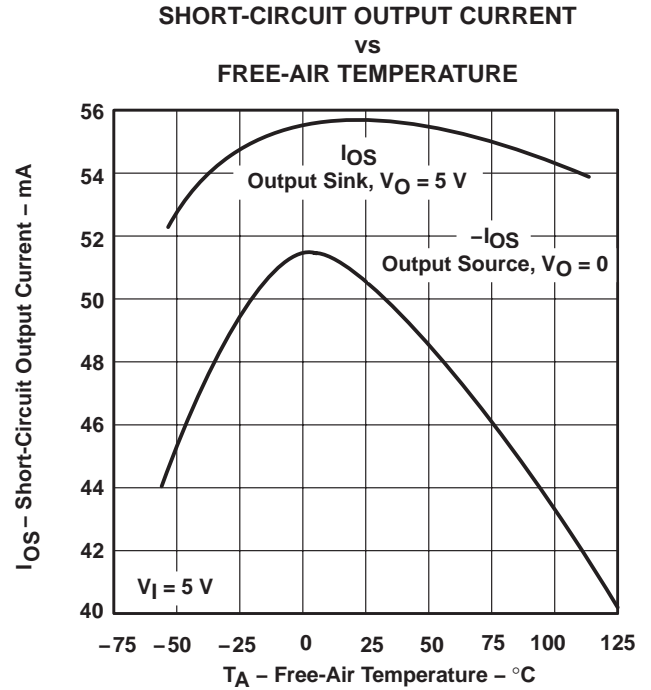

Figure 10

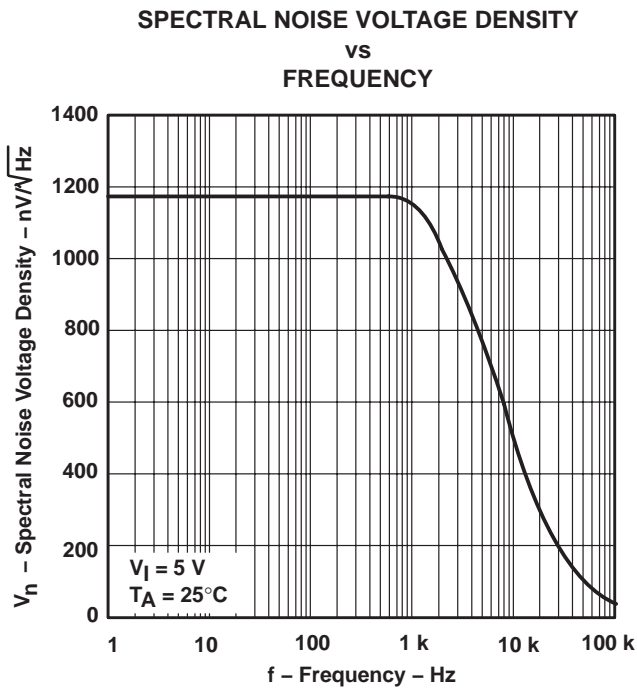

Figure 11

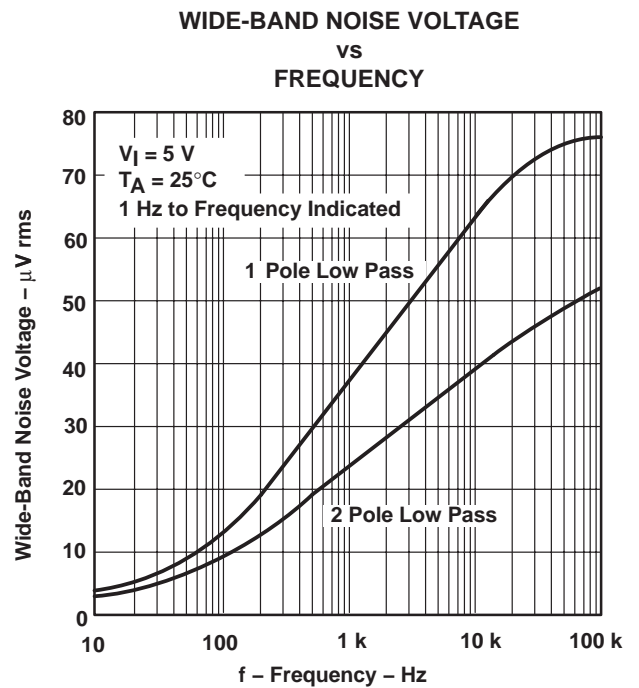

Figure 12

TYPICAL CHARACTERISTICS

OUTPUT VOLTAGE RESPONSE TO OUTPUT CURRENT STEP VS TIME

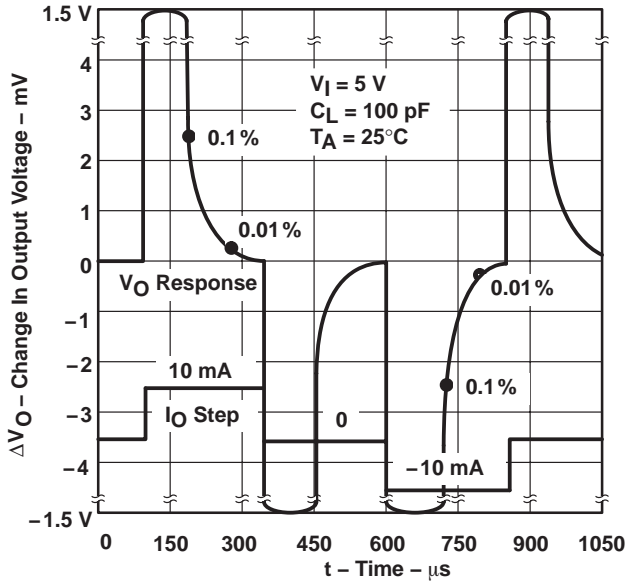

Figure 13

OUTPUT VOLTAGE RESPONSE TO INPUT VOLTAGE STEP VS TIME

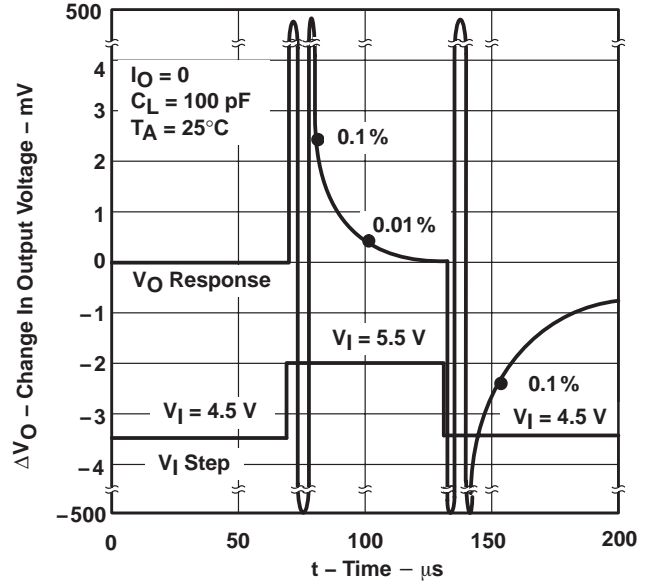

Figure 14

OUTPUT VOLTAGE POWER-UP RESPONSE VS TIME

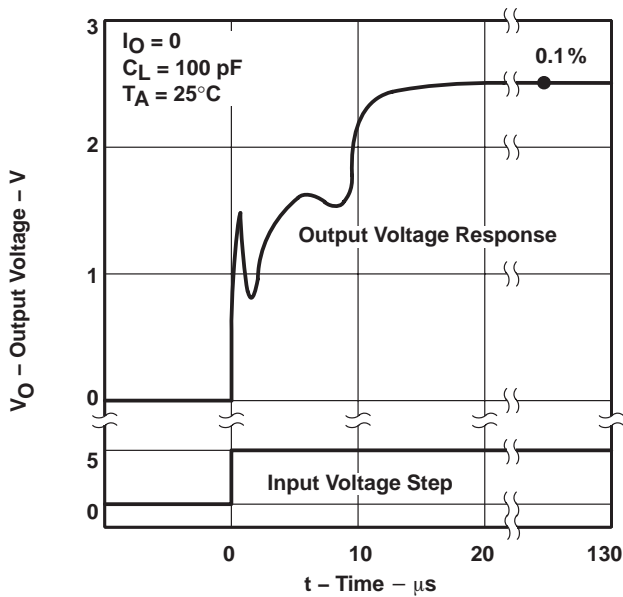

Figure 15

STABILITY RANGE OUTPUT CURRENT VS LOAD CAPACITANCE

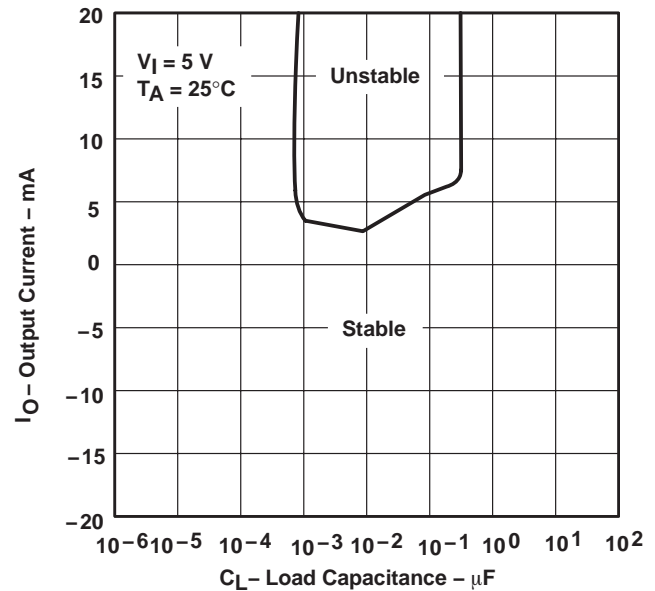

Figure 16

macromodel information

```
* TLE2425 OPERATIONAL AMPLIFIER "MACROMODEL" SUBCIRCUIT
* CREATED USING PARTS RELEASE 4.03 ON 08/21/90 AT 13:51
* REV (N/A) SUPPLY VOLTAGE: 5 V
* CONNECTIONS: INPUT
*
*           | COMMON
*           | OUTPUT
*
.SUBCKT TLE2425 3 4 5
*
```

```
* OPAMP SECTION
C1      11 12 21.66E-12
C2      6 7 30.00E-12
C3      87 0 10.64E-9
CPSR    85 86 15.9E-9
DCM+    81 82 DX
DCM-    83 81 DX
DC      5 53 DX
DE      54 5 DX
DLN     92 90 DX
DLP     90 91 DX
DP      4 3 DX
ECMR    84 99 (2,99) 1
EGND    99 0 POLY(2) (3,0) (4,0) 0 .5 .5
EPSR    85 0 POLY(1) (3,4) -16.22E-6 3.24E-6
ENSE    89 2 POLY(1) (88,0) 120E-6 1
FB      7 99 POLY(6) VB VC VE VLP VLN VPSR 0 74.8E6 -10E6 10E6 10E6
+ -10E6 74E6
GA      6 0 11 12 320.4E-6
GCM     0 6 10 99 1.013E-9
GPSR    85 86 (85,86) 100E-6
GRC1    4 11 (4,11) 3.204E-4
GRC2    4 12 (4,12) 3.204E-4
GRE1    13 10 (13,10) 1.038E-3
GRE2    14 10 (14,10) 1.038E-3
HLIM    90 0 VLIM 1K
HCMR    80 1 POLY(2) VCM+ VCM- 0 1E2 1E2
IRP     3 4 146E-6
IEE     3 10 DC 24.05E-6
IIO     2 0 .2E-9
I1      88 0 1E-21
Q1      11 89 13 QX
Q2      12 80 14 QX
R2      6 9 100.0E3
RCM     84 81 1K
REE     10 99 8.316E6
RN1     87 0 2.55E8
RN2     87 88 11.67E3
```

TLE2425 PRECISION VIRTUAL GROUND

SLOS065D – MARCH 1991 – REVISED APRIL 2002

macromodel information (continued)

```
RO1      8  5  63
RO2      7 99  62
VCM+    82 99  1.0
VCM-    83 99 -2.3
VB       9  0  DC  0
VC       3 53  DC  1.400
VE      54  4  DC  1.400
VLIM     7  8  DC  0
VLP     91  0  DC  30
VLN      0 92  DC  30
VPSR     0 86  DC  0
RFB      5  2  1K
RIN     30  1  1K
RCOM    34  4  .1
*REGULATOR SECTION
RG1     30  0  20MEG
RG2     30 31  .2
RG3     31 35  400K
RG4     35 34  411K
RG5     31 36  25MEG
HREG    31 32  POLY(2)   VPSET VNSET  0  1E2 1E2
VREG    32 33  DC  0V
EREG    33 34  POLY(1)   (36,34)  1.23  1
VADJ    36 34  1.27V
HPSET   37  0  VREG  1.030E3
VPSET   38  0  DC  20V
HNSET   39  0  VREG  6.11E5
VNSET   40  0  DC -20V
DSUB    4  34  DX
DPOS    37 38  DX
DNNEG   40 39  DX
.MODEL DX D(IS=800.0E-18)
.MODEL QX PNP(IS=800.0E-18 BF=480)
.ENDS
```



PACKAGING INFORMATION

Orderable Device	Status ⁽¹⁾	Package Type	Package Drawing	Pins	Package Qty	Eco Plan ⁽²⁾	Lead/Ball Finish	MSL Peak Temp ⁽³⁾
5962-9555601Q2A	OBSOLETE	LCCC	FK	20		TBD	Call TI	Call TI
5962-9555601QPA	OBSOLETE	CDIP	JG	8		TBD	Call TI	Call TI
TLE2425CD	ACTIVE	SOIC	D	8	75	Green (RoHS & no Sb/Br)	CU NIPDAU	Level-1-260C-UNLIM
TLE2425CDG4	ACTIVE	SOIC	D	8	75	Green (RoHS & no Sb/Br)	CU NIPDAU	Level-1-260C-UNLIM
TLE2425CDR	ACTIVE	SOIC	D	8	2500	Green (RoHS & no Sb/Br)	CU NIPDAU	Level-1-260C-UNLIM
TLE2425CDRG4	ACTIVE	SOIC	D	8	2500	Green (RoHS & no Sb/Br)	CU NIPDAU	Level-1-260C-UNLIM
TLE2425CLP	ACTIVE	TO-92	LP	3	1000	Pb-Free (RoHS)	CU SN	N / A for Pkg Type
TLE2425CLPE3	ACTIVE	TO-92	LP	3	1000	Pb-Free (RoHS)	CU SN	N / A for Pkg Type
TLE2425CLPR	OBSOLETE	TO-92	LP	3		TBD	Call TI	Call TI
TLE2425CPS	ACTIVE	SO	PS	8	80	Green (RoHS & no Sb/Br)	CU NIPDAU	Level-1-260C-UNLIM
TLE2425CPSG4	ACTIVE	SO	PS	8	80	Green (RoHS & no Sb/Br)	CU NIPDAU	Level-1-260C-UNLIM
TLE2425CPSR	ACTIVE	SO	PS	8	2000	Green (RoHS & no Sb/Br)	CU NIPDAU	Level-1-260C-UNLIM
TLE2425CPSRG4	ACTIVE	SO	PS	8	2000	Green (RoHS & no Sb/Br)	CU NIPDAU	Level-1-260C-UNLIM
TLE2425ID	ACTIVE	SOIC	D	8	75	Green (RoHS & no Sb/Br)	CU NIPDAU	Level-1-260C-UNLIM
TLE2425IDG4	ACTIVE	SOIC	D	8	75	Green (RoHS & no Sb/Br)	CU NIPDAU	Level-1-260C-UNLIM
TLE2425IDR	ACTIVE	SOIC	D	8	2500	Green (RoHS & no Sb/Br)	CU NIPDAU	Level-1-260C-UNLIM
TLE2425IDRG4	ACTIVE	SOIC	D	8	2500	Green (RoHS & no Sb/Br)	CU NIPDAU	Level-1-260C-UNLIM
TLE2425ILP	ACTIVE	TO-92	LP	3	1000	Pb-Free (RoHS)	CU SN	N / A for Pkg Type
TLE2425ILPE3	ACTIVE	TO-92	LP	3	1000	Pb-Free (RoHS)	CU SN	N / A for Pkg Type
TLE2425MD	ACTIVE	SOIC	D	8	75	TBD	CU NIPDAU	Level-1-220C-UNLIM
TLE2425MDG4	ACTIVE	SOIC	D	8	75	Green (RoHS & no Sb/Br)	CU NIPDAU	Level-1-260C-UNLIM
TLE2425MDR	ACTIVE	SOIC	D	8	2500	TBD	CU NIPDAU	Level-1-220C-UNLIM
TLE2425MDRG4	ACTIVE	SOIC	D	8	2500	Green (RoHS & no Sb/Br)	CU NIPDAU	Level-1-260C-UNLIM
TLE2425MFKB	OBSOLETE	LCCC	FK	20		TBD	Call TI	Call TI
TLE2425MJG	OBSOLETE	CDIP	JG	8		TBD	Call TI	Call TI
TLE2425MJGB	OBSOLETE	CDIP	JG	8		TBD	Call TI	Call TI
TLE2425MLP	OBSOLETE	TO-92	LP	3		TBD	Call TI	Call TI

⁽¹⁾ The marketing status values are defined as follows:
ACTIVE: Product device recommended for new designs.

LIFEBUY: TI has announced that the device will be discontinued, and a lifetime-buy period is in effect.

NRND: Not recommended for new designs. Device is in production to support existing customers, but TI does not recommend using this part in a new design.

PREVIEW: Device has been announced but is not in production. Samples may or may not be available.

OBSOLETE: TI has discontinued the production of the device.

⁽²⁾ Eco Plan - The planned eco-friendly classification: Pb-Free (RoHS), Pb-Free (RoHS Exempt), or Green (RoHS & no Sb/Br) - please check <http://www.ti.com/productcontent> for the latest availability information and additional product content details.

TBD: The Pb-Free/Green conversion plan has not been defined.

Pb-Free (RoHS): TI's terms "Lead-Free" or "Pb-Free" mean semiconductor products that are compatible with the current RoHS requirements for all 6 substances, including the requirement that lead not exceed 0.1% by weight in homogeneous materials. Where designed to be soldered at high temperatures, TI Pb-Free products are suitable for use in specified lead-free processes.

Pb-Free (RoHS Exempt): This component has a RoHS exemption for either 1) lead-based flip-chip solder bumps used between the die and package, or 2) lead-based die adhesive used between the die and leadframe. The component is otherwise considered Pb-Free (RoHS compatible) as defined above.

Green (RoHS & no Sb/Br): TI defines "Green" to mean Pb-Free (RoHS compatible), and free of Bromine (Br) and Antimony (Sb) based flame retardants (Br or Sb do not exceed 0.1% by weight in homogeneous material)

⁽³⁾ MSL, Peak Temp. -- The Moisture Sensitivity Level rating according to the JEDEC industry standard classifications, and peak solder temperature.

Important Information and Disclaimer:The information provided on this page represents TI's knowledge and belief as of the date that it is provided. TI bases its knowledge and belief on information provided by third parties, and makes no representation or warranty as to the accuracy of such information. Efforts are underway to better integrate information from third parties. TI has taken and continues to take reasonable steps to provide representative and accurate information but may not have conducted destructive testing or chemical analysis on incoming materials and chemicals. TI and TI suppliers consider certain information to be proprietary, and thus CAS numbers and other limited information may not be available for release.

In no event shall TI's liability arising out of such information exceed the total purchase price of the TI part(s) at issue in this document sold by TI to Customer on an annual basis.

TAPE AND REEL INFORMATION

QUADRANT ASSIGNMENTS FOR PIN 1 ORIENTATION IN TAPE

*All dimensions are nominal

Device	Package Type	Package Drawing	Pins	SPQ	Reel Diameter (mm)	Reel Width W1 (mm)	A0 (mm)	B0 (mm)	K0 (mm)	P1 (mm)	W (mm)	Pin1 Quadrant
TLE2425CDR	SOIC	D	8	2500	330.0	12.4	6.4	5.2	2.1	8.0	12.0	Q1
TLE2425CPSR	SO	PS	8	2000	330.0	16.4	8.2	6.6	2.5	12.0	16.0	Q1
TLE2425IDR	SOIC	D	8	2500	330.0	12.4	6.4	5.2	2.1	8.0	12.0	Q1
TLE2425MDR	SOIC	D	8	2500	330.0	12.4	6.4	5.2	2.1	8.0	12.0	Q1

TAPE AND REEL BOX DIMENSIONS

*All dimensions are nominal

Device	Package Type	Package Drawing	Pins	SPQ	Length (mm)	Width (mm)	Height (mm)
TLE2425CDR	SOIC	D	8	2500	346.0	346.0	29.0
TLE2425CPSR	SO	PS	8	2000	346.0	346.0	33.0
TLE2425IDR	SOIC	D	8	2500	346.0	346.0	29.0
TLE2425MDR	SOIC	D	8	2500	346.0	346.0	29.0

JG (R-GDIP-T8)

CERAMIC DUAL-IN-LINE



- NOTES: A. All linear dimensions are in inches (millimeters).
 B. This drawing is subject to change without notice.
 C. This package can be hermetically sealed with a ceramic lid using glass frit.
 D. Index point is provided on cap for terminal identification.
 E. Falls within MIL STD 1835 GDIP1-T8

FK (S-CQCC-N**)

LEADLESS CERAMIC CHIP CARRIER

28 TERMINAL SHOWN

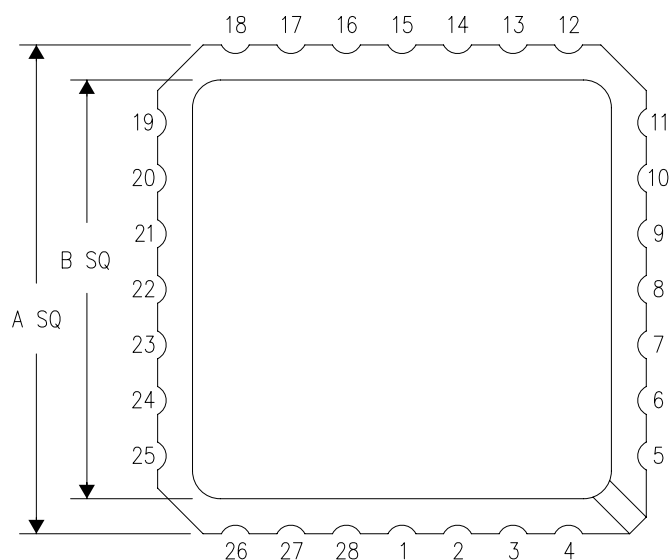

NO. OF TERMINALS **	A		B	
	MIN	MAX	MIN	MAX
20	0.342 (8,69)	0.358 (9,09)	0.307 (7,80)	0.358 (9,09)
28	0.442 (11,23)	0.458 (11,63)	0.406 (10,31)	0.458 (11,63)
44	0.640 (16,26)	0.660 (16,76)	0.495 (12,58)	0.560 (14,22)
52	0.740 (18,78)	0.761 (19,32)	0.495 (12,58)	0.560 (14,22)
68	0.938 (23,83)	0.962 (24,43)	0.850 (21,6)	0.858 (21,8)
84	1.141 (28,99)	1.165 (29,59)	1.047 (26,6)	1.063 (27,0)

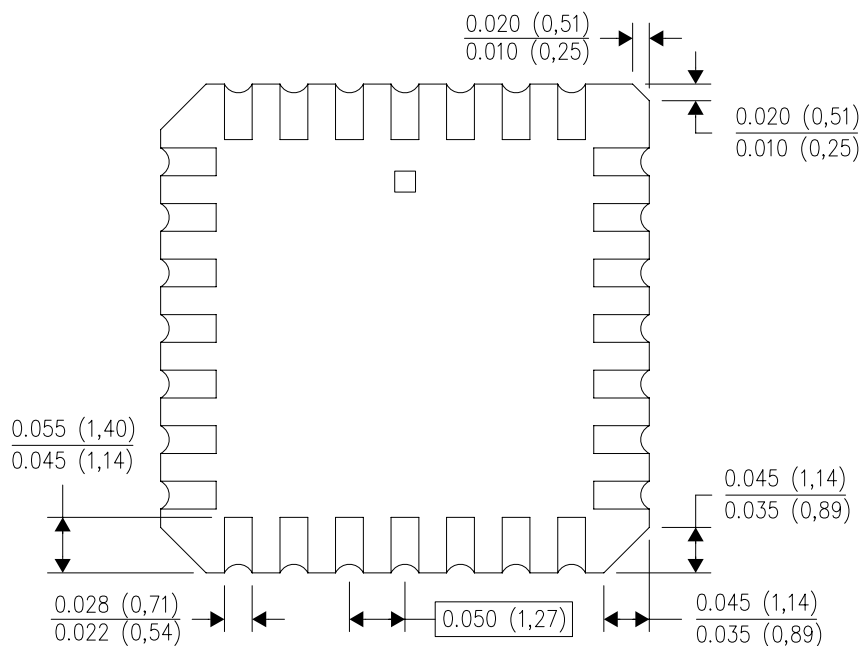

4040140/D 01/11

- NOTES:
- All linear dimensions are in inches (millimeters).
 - This drawing is subject to change without notice.
 - This package can be hermetically sealed with a metal lid.
 - Falls within JEDEC MS-004

D (R-PDSO-G8)

PLASTIC SMALL OUTLINE

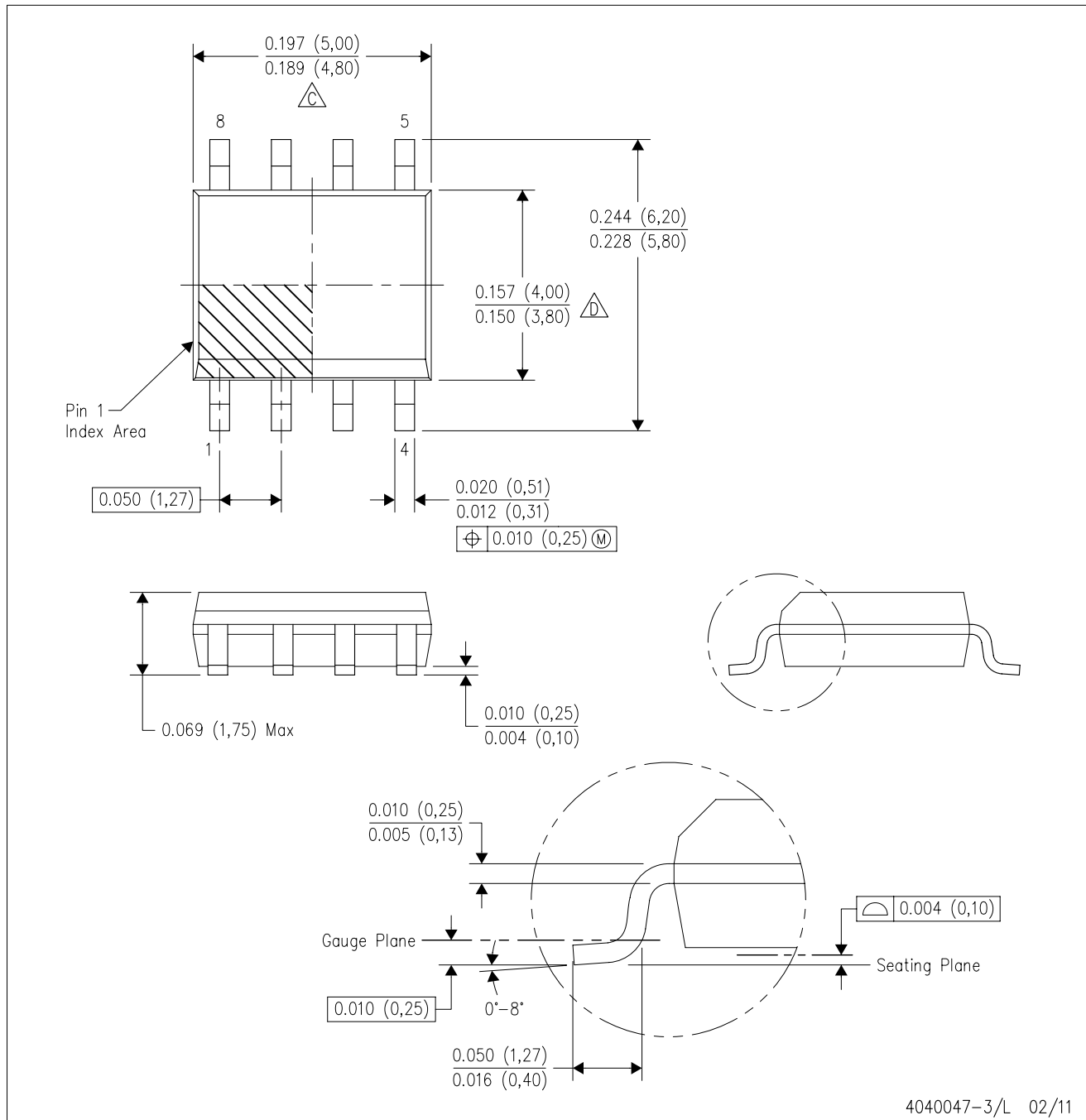

- NOTES:
- A. All linear dimensions are in inches (millimeters).
 - B. This drawing is subject to change without notice.
 - Body length does not include mold flash, protrusions, or gate burrs. Mold flash, protrusions, or gate burrs shall not exceed 0.006 (0,15) each side.
 - Body width does not include interlead flash. Interlead flash shall not exceed 0.017 (0,43) each side.
 - E. Reference JEDEC MS-012 variation AA.

D (R-PDSO-G8)

PLASTIC SMALL OUTLINE

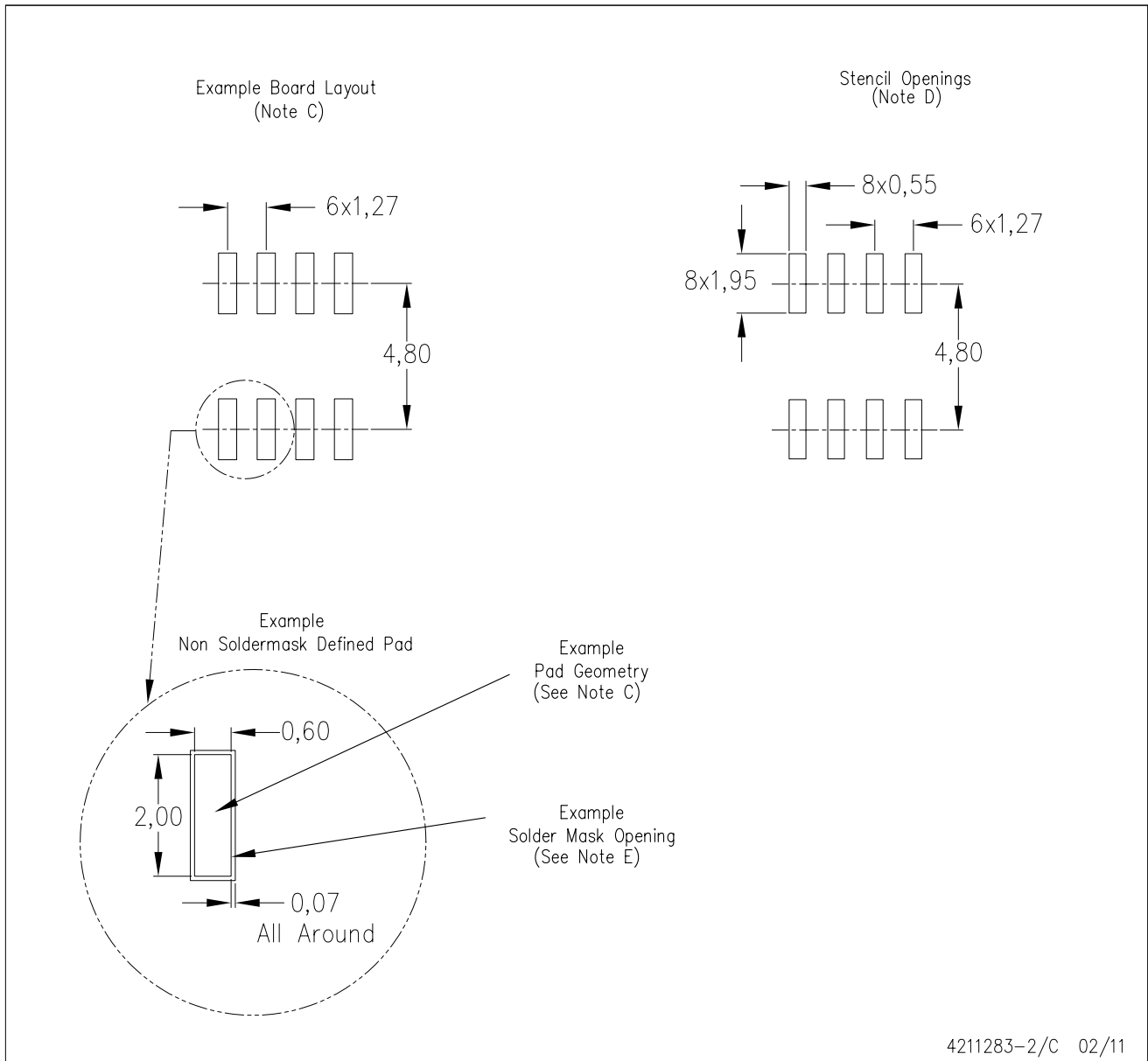

- NOTES:
- All linear dimensions are in millimeters.
 - This drawing is subject to change without notice.
 - Publication IPC-7351 is recommended for alternate designs.
 - Laser cutting apertures with trapezoidal walls and also rounding corners will offer better paste release. Customers should contact their board assembly site for stencil design recommendations. Refer to IPC-7525 for other stencil recommendations.
 - Customers should contact their board fabrication site for solder mask tolerances between and around signal pads.

MECHANICAL DATA

PS (R-PDSO-G8)

PLASTIC SMALL-OUTLINE PACKAGE

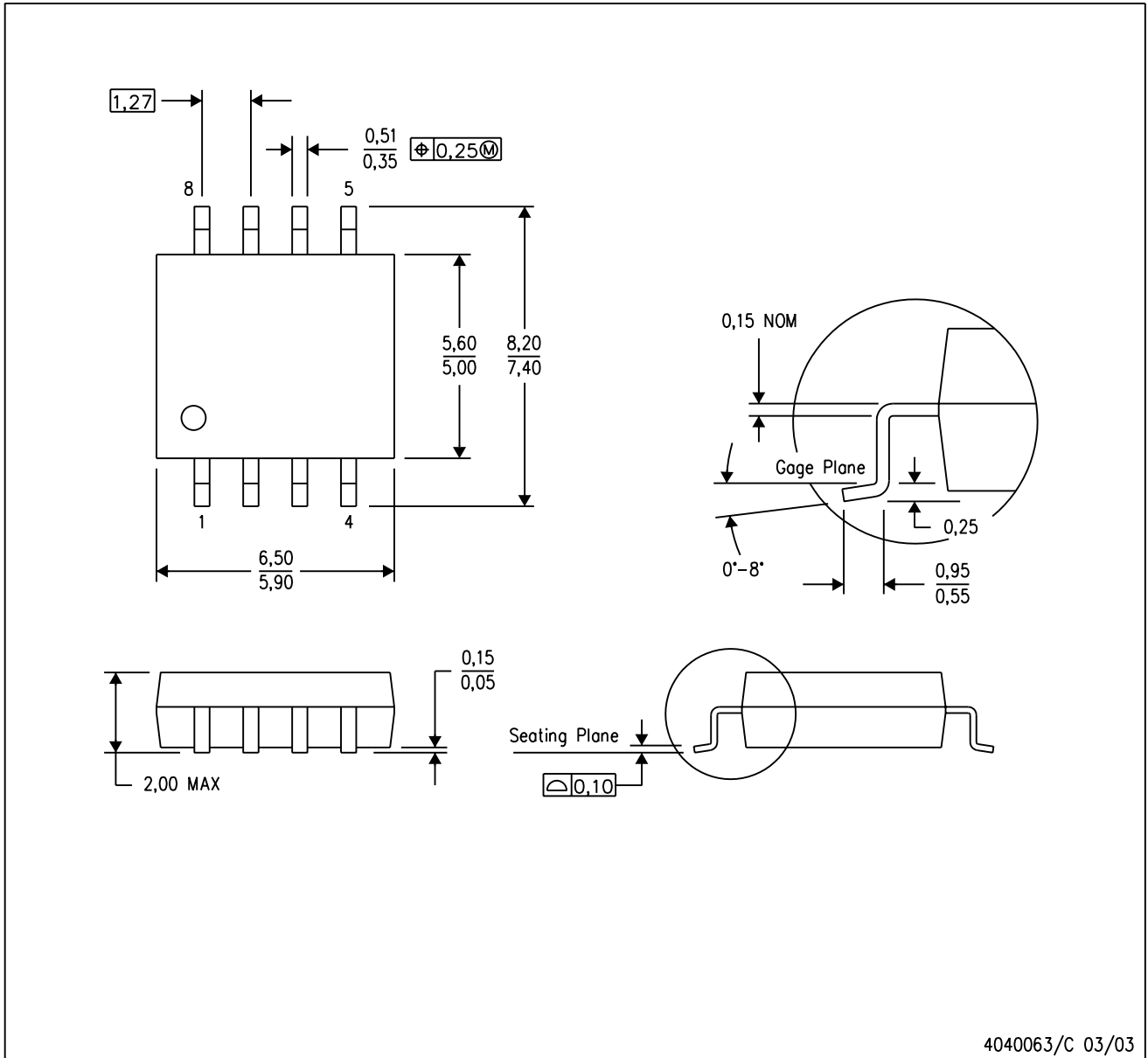

- NOTES:
- A. All linear dimensions are in millimeters.
 - B. This drawing is subject to change without notice.
 - C. Body dimensions do not include mold flash or protrusion, not to exceed 0,15.

LP (O-PBCY-W3)

PLASTIC CYLINDRICAL PACKAGE

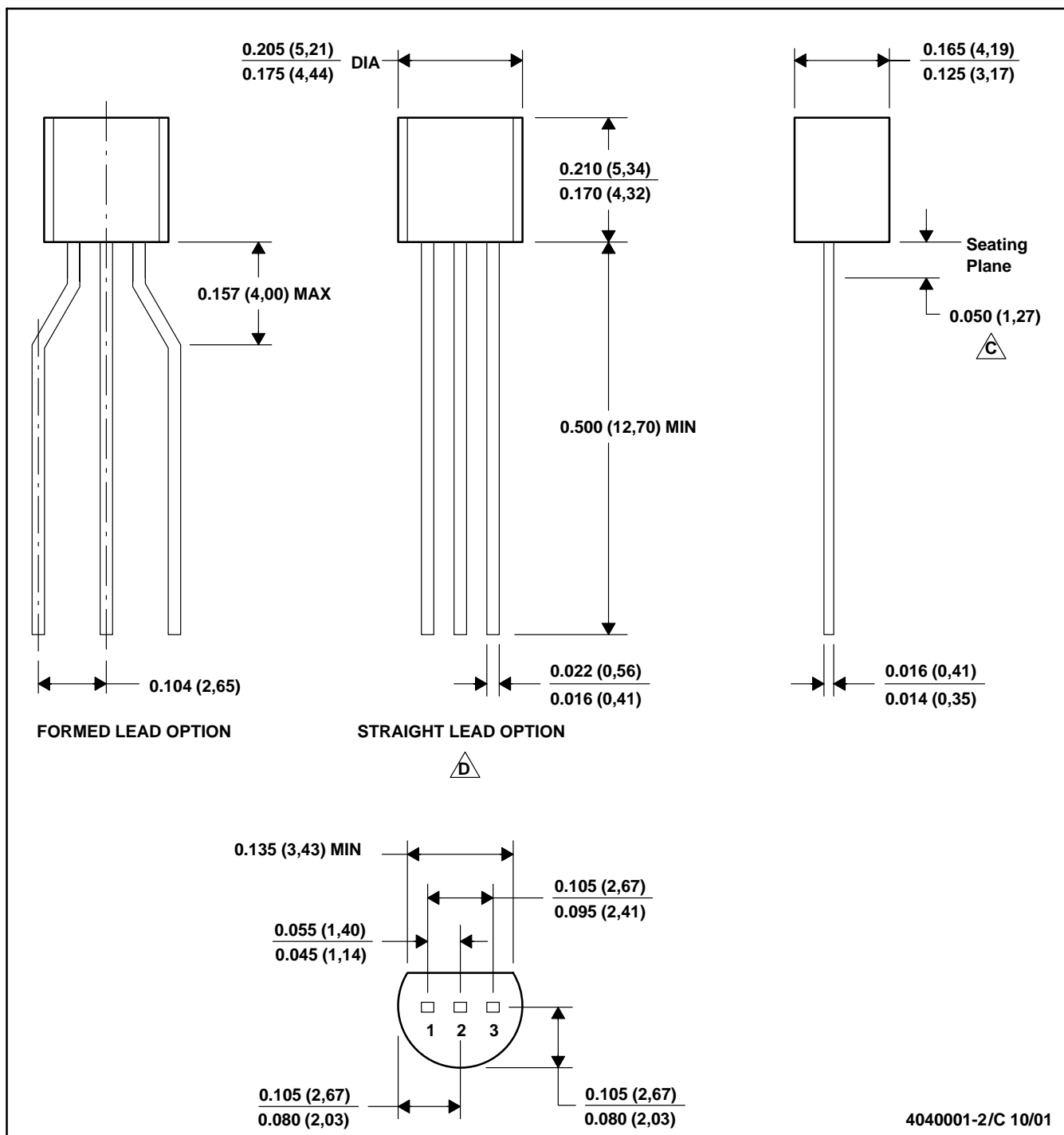

- NOTES: A. All linear dimensions are in inches (millimeters).
 B. This drawing is subject to change without notice.
 C. Lead dimensions are not controlled within this area
 D. Falls within JEDEC TO -226 Variation AA (TO-226 replaces TO-92)
 E. Shipping Method:
 Straight lead option available in bulk pack only.
 Formed lead option available in tape & reel or ammo pack.

MECHANICAL DATA

MSOT002A – OCTOBER 1994 – REVISED NOVEMBER 2001

LP (O-PBCY-W3)

PLASTIC CYLINDRICAL PACKAGE

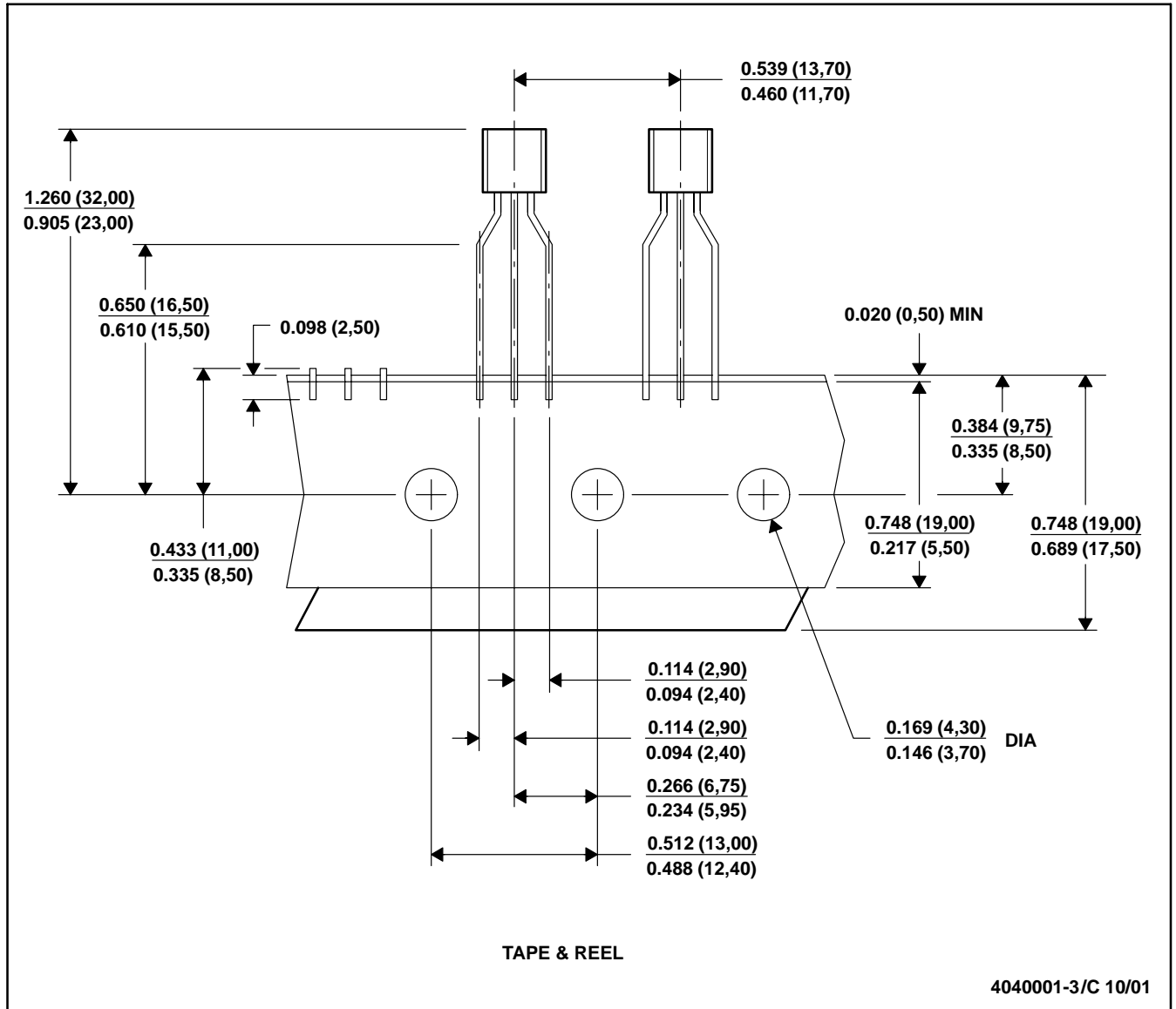

- NOTES: A. All linear dimensions are in inches (millimeters).
B. This drawing is subject to change without notice.
C. Tape and Reel information for the Format Lead Option package.

IMPORTANT NOTICE

Texas Instruments Incorporated and its subsidiaries (TI) reserve the right to make corrections, modifications, enhancements, improvements, and other changes to its products and services at any time and to discontinue any product or service without notice. Customers should obtain the latest relevant information before placing orders and should verify that such information is current and complete. All products are sold subject to TI's terms and conditions of sale supplied at the time of order acknowledgment.

TI warrants performance of its hardware products to the specifications applicable at the time of sale in accordance with TI's standard warranty. Testing and other quality control techniques are used to the extent TI deems necessary to support this warranty. Except where mandated by government requirements, testing of all parameters of each product is not necessarily performed.

TI assumes no liability for applications assistance or customer product design. Customers are responsible for their products and applications using TI components. To minimize the risks associated with customer products and applications, customers should provide adequate design and operating safeguards.

TI does not warrant or represent that any license, either express or implied, is granted under any TI patent right, copyright, mask work right, or other TI intellectual property right relating to any combination, machine, or process in which TI products or services are used. Information published by TI regarding third-party products or services does not constitute a license from TI to use such products or services or a warranty or endorsement thereof. Use of such information may require a license from a third party under the patents or other intellectual property of the third party, or a license from TI under the patents or other intellectual property of TI.

Reproduction of TI information in TI data books or data sheets is permissible only if reproduction is without alteration and is accompanied by all associated warranties, conditions, limitations, and notices. Reproduction of this information with alteration is an unfair and deceptive business practice. TI is not responsible or liable for such altered documentation. Information of third parties may be subject to additional restrictions.

Resale of TI products or services with statements different from or beyond the parameters stated by TI for that product or service voids all express and any implied warranties for the associated TI product or service and is an unfair and deceptive business practice. TI is not responsible or liable for any such statements.

TI products are not authorized for use in safety-critical applications (such as life support) where a failure of the TI product would reasonably be expected to cause severe personal injury or death, unless officers of the parties have executed an agreement specifically governing such use. Buyers represent that they have all necessary expertise in the safety and regulatory ramifications of their applications, and acknowledge and agree that they are solely responsible for all legal, regulatory and safety-related requirements concerning their products and any use of TI products in such safety-critical applications, notwithstanding any applications-related information or support that may be provided by TI. Further, Buyers must fully indemnify TI and its representatives against any damages arising out of the use of TI products in such safety-critical applications.

TI products are neither designed nor intended for use in military/aerospace applications or environments unless the TI products are specifically designated by TI as military-grade or "enhanced plastic." Only products designated by TI as military-grade meet military specifications. Buyers acknowledge and agree that any such use of TI products which TI has not designated as military-grade is solely at the Buyer's risk, and that they are solely responsible for compliance with all legal and regulatory requirements in connection with such use.

TI products are neither designed nor intended for use in automotive applications or environments unless the specific TI products are designated by TI as compliant with ISO/TS 16949 requirements. Buyers acknowledge and agree that, if they use any non-designated products in automotive applications, TI will not be responsible for any failure to meet such requirements.

Following are URLs where you can obtain information on other Texas Instruments products and application solutions:

Products

Audio	www.ti.com/audio
Amplifiers	amplifier.ti.com
Data Converters	dataconverter.ti.com
DLP® Products	www.dlp.com
DSP	dsp.ti.com
Clocks and Timers	www.ti.com/clocks
Interface	interface.ti.com
Logic	logic.ti.com
Power Mgmt	power.ti.com
Microcontrollers	microcontroller.ti.com
RFID	www.ti-rfid.com
RF/IF and ZigBee® Solutions	www.ti.com/lprf

Applications

Communications and Telecom	www.ti.com/communications
Computers and Peripherals	www.ti.com/computers
Consumer Electronics	www.ti.com/consumer-apps
Energy and Lighting	www.ti.com/energy
Industrial	www.ti.com/industrial
Medical	www.ti.com/medical
Security	www.ti.com/security
Space, Avionics and Defense	www.ti.com/space-avionics-defense
Transportation and Automotive	www.ti.com/automotive
Video and Imaging	www.ti.com/video
Wireless	www.ti.com/wireless-apps

TI E2E Community Home Page

e2e.ti.com

Mailing Address: Texas Instruments, Post Office Box 655303, Dallas, Texas 75265
Copyright © 2011, Texas Instruments Incorporated