

Chassis & P.C. Board Mount

PULSE TRANSFORMERS

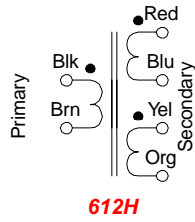

- Economical, open style, chassis mount.
- Mounting hole (G) - .187"
- Units are intended for pulse applications including thyristor / triac firing circuits.
- Flexible leads - 4" minimum.

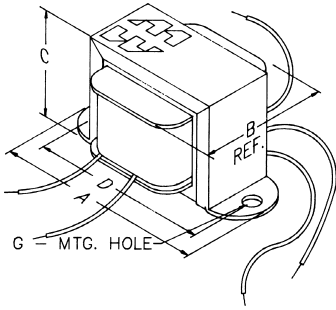
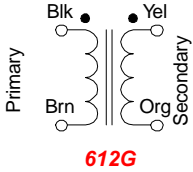

Cat. No.	Ratio	Circuit Max. Volts	Primary		D.C. Winding Resistance		Insulation RMS (Volts)	Wt. Oz.	Dimensions			
			Inductance mH (min.)	D.C. Res. (Ohms)	Sec. 1 (Ohms)	Sec. 2 (Ohms)			A	B	C	D
612G	1:1	600	6.6	0.87	0.87	-	4000	8.0	2.06	1.25	1.19	1.75
612H	1:1:1	600	1.5	0.45	0.42	0.49	4000	8.0	2.06	1.25	1.19	1.75

PULSE TRANSFORMERS

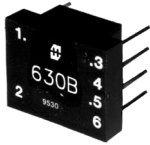

630 Series - Dimensions & Schematic

- These transformers are fully encapsulated in a high grade black molded case with a UL94V-O rating.
- They are intended mainly for thyristor / triac triggering applications.
- All units are voltage proof tested between windings at 2500V RMS for 1 minute, for a working voltage rating maximum of 440V RMS.
- Transformers with three or more windings can be series connected to obtain alternative ratios. (ie...a 1:1:1 type may be series connected by linking pins 4 & 5 in which case 3-6 are used as the primary winding to obtain a ratio of 2:1 etc.)

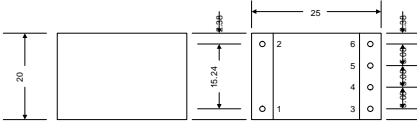

All Dimensions in mm
Pins 0.64 sq.

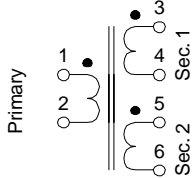

640 Series - Dimensions & Schematic

Cat. No.	Turns Ratio	Primary		Leakage Inductance uH (max)	Capacity pf. (max)	D.C. Winding Resistance (ohms)			
		Inductance mH (min.)	ET Constant V uS			Pri.	Sec. 1	Sec. 2	Sec. 3
630B	1:1	1	120	2.0	50	0.25	0.23	-	-
631B	1:1:1	1	120	3	40	0.25	0.22	0.28	-
632B	2:1:1	1	120	3.5	30	0.24	0.12	0.15	-
630C	1:1	4	240	5	55	0.86	0.83	-	-
631C	1:1:1	4	240	11	35	0.9	0.76	1.1	-
632C	2:1:1	4	240	11	35	0.84	0.38	0.5	-
630D	1:1	16.3	482	18	65	3.5	3.4	-	-
631D	1:1:1	16.3	482	40	40	3.6	3.1	4.2	-
632D	2:1:1	16.3	482	40	40	3.5	1.6	2.0	-
640A	2:1:1:1	10	370	38	32	2.3	1.1	1.3	1.0
640B	2:1:1:1	30	640	110	38	6.6	3.0	3.8	2.7
640C	2:1:1:1	100	1160	340	35	25.0	12.0	14.6	10.8
641A	2:1:1:1	10	890	28	65	0.45	0.2	0.26	0.19
641B	2:1:1:1	30	1520	75	70	1.2	0.5	0.65	0.46
641C	2:1:1:1	100	2760	190	190	5.2	2.4	2.9	2.2

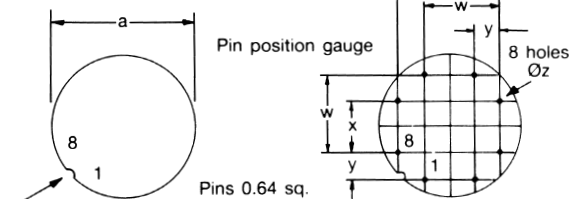

Positions of pins 1 and 8 and type number marked on this face

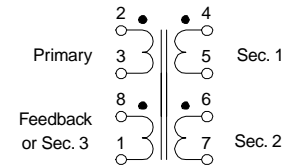
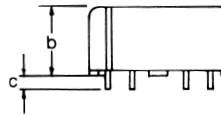

Cat. Series No.	Tol.	Dimensions							
		a	b	c	v	w	x	y	z
640 Series	Max.	25.0	12.7	-	17.98	12.9	7.82	5.28	1.2
	Min.	-	-	4.0	17.58	12.47	7.42	4.88	1.1
641 Series	Max.	36.0	20.2	-	28.12	20.52	12.90	7.82	1.2
	Min.	-	-	4.0	27.72	20.12	12.47	7.42	1.1