

SN74SSTV16859

13-BIT TO 26-BIT REGISTERED BUFFER WITH SSTL_2 INPUTS AND OUTPUTS

SCES297D – FEBRUARY 2000 – REVISED AUGUST 2004

- Member of the Texas Instruments Widebus™ Family
- 1-to-2 Outputs to Support Stacked DDR DIMMs
- Supports SSTL_2 Data Inputs
- Outputs Meet SSTL_2 Class II Specifications
- Differential Clock (CLK and $\overline{\text{CLK}}$) Inputs
- Supports LVCMOS Switching Levels on the $\overline{\text{RESET}}$ Input
- $\overline{\text{RESET}}$ Input Disables Differential Input Receivers, Resets All Registers, and Forces All Outputs Low
- Pinout Optimizes DIMM PCB Layout
- Latch-Up Performance Exceeds 100 mA Per JESD 78, Class II
- ESD Protection Exceeds JESD 22
 - 2000-V Human-Body Model (A114-A)
 - 200-V Machine Model (A115-A)

**DGG PACKAGE
(TOP VIEW)**

Q13A	1	64	V _{DDQ}
Q12A	2	63	GND
Q11A	3	62	D13
Q10A	4	61	D12
Q9A	5	60	V _{CC}
V _{DDQ}	6	59	V _{DDQ}
GND	7	58	GND
Q8A	8	57	D11
Q7A	9	56	D10
Q6A	10	55	D9
Q5A	11	54	GND
Q4A	12	53	D8
Q3A	13	52	D7
Q2A	14	51	$\overline{\text{RESET}}$
GND	15	50	GND
Q1A	16	49	$\overline{\text{CLK}}$
Q13B	17	48	CLK
V _{DDQ}	18	47	V _{DDQ}
Q12B	19	46	V _{CC}
Q11B	20	45	V _{REF}
Q10B	21	44	D6
Q9B	22	43	GND
Q8B	23	42	D5
Q7B	24	41	D4
Q6B	25	40	D3
GND	26	39	GND
V _{DDQ}	27	38	V _{DDQ}
Q5B	28	37	V _{CC}
Q4B	29	36	D2
Q3B	30	35	D1
Q2B	31	34	GND
Q1B	32	33	V _{DDQ}

description/ordering information

This 13-bit to 26-bit registered buffer is designed for 2.3-V to 2.7-V V_{CC} operation.

All inputs are SSTL_2, except the LVCMOS reset ($\overline{\text{RESET}}$) input. All outputs are SSTL_2, Class II compatible.

The SN74SSTV16859 operates from a differential clock (CLK and $\overline{\text{CLK}}$). Data are registered at the crossing of CLK going high and $\overline{\text{CLK}}$ going low.

ORDERING INFORMATION

T _A	PACKAGE†	ORDERABLE PART NUMBER	TOP-SIDE MARKING
0°C to 70°C	QFN – RGQ (Tin–Pb Finish)	Tape and reel	SS859
	QFN – RGQ (Matte–Tin Finish)		
	TSSOP – DGG	Tape and reel	SN74SSTV16859DGGR

† Package drawings, standard packing quantities, thermal data, symbolization, and PCB design guidelines are available at www.ti.com/sc/package.



Please be aware that an important notice concerning availability, standard warranty, and use in critical applications of Texas Instruments semiconductor products and disclaimers thereto appears at the end of this data sheet.

Widebus is a trademark of Texas Instruments.

PRODUCTION DATA information is current as of publication date. Products conform to specifications per the terms of Texas Instruments standard warranty. Production processing does not necessarily include testing of all parameters.



POST OFFICE BOX 655303 • DALLAS, TEXAS 75265

Copyright © 2004, Texas Instruments Incorporated

SN74SSTV16859
13-BIT TO 26-BIT REGISTERED BUFFER
WITH SSTL 2 INPUTS AND OUTPUTS

SCES297D – FEBRUARY 2000 – REVISED AUGUST 2004

description/ordering information (continued)

The device supports low-power standby operation. When $\overline{\text{RESET}}$ is low, the differential input receivers are disabled, and undriven (floating) data, clock, and reference voltage (V_{REF}) inputs are allowed. In addition, when $\overline{\text{RESET}}$ is low, all registers are reset, and all outputs are forced low. The LVCMOS $\overline{\text{RESET}}$ input always must be held at a valid logic high or low level.

To ensure defined outputs from the register before a stable clock has been supplied, $\overline{\text{RESET}}$ must be held in the low state during power up.

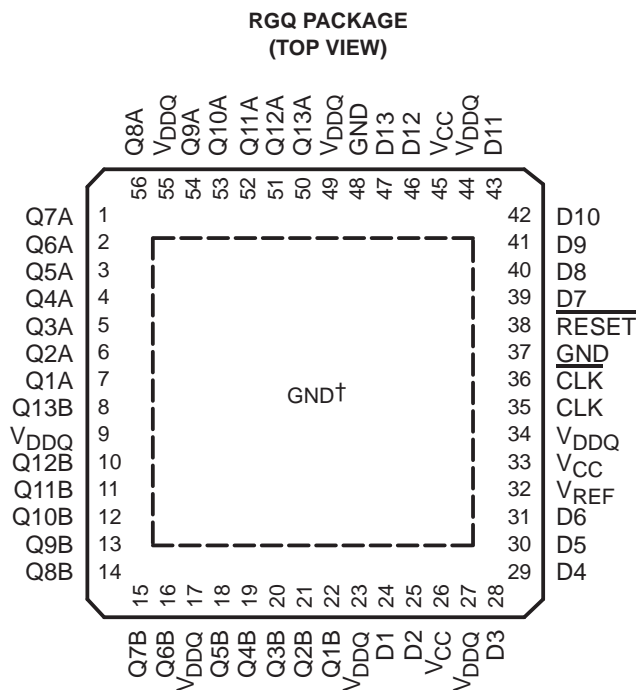

† The center die pad must be connected to GND.

FUNCTION TABLE

INPUTS				OUTPUT
$\overline{\text{RESET}}$	CLK	$\overline{\text{CLK}}$	D	Q
H	↑	↓	H	H
H	↑	↓	L	L
H	L or H	L or H	X	Q_0
L	X or floating	X or floating	X or floating	L

SN74SSTV16859
13-BIT TO 26-BIT REGISTERED BUFFER
WITH SSTL 2 INPUTS AND OUTPUTS

SCES297D – FEBRUARY 2000 – REVISED AUGUST 2004

logic diagram (positive logic)

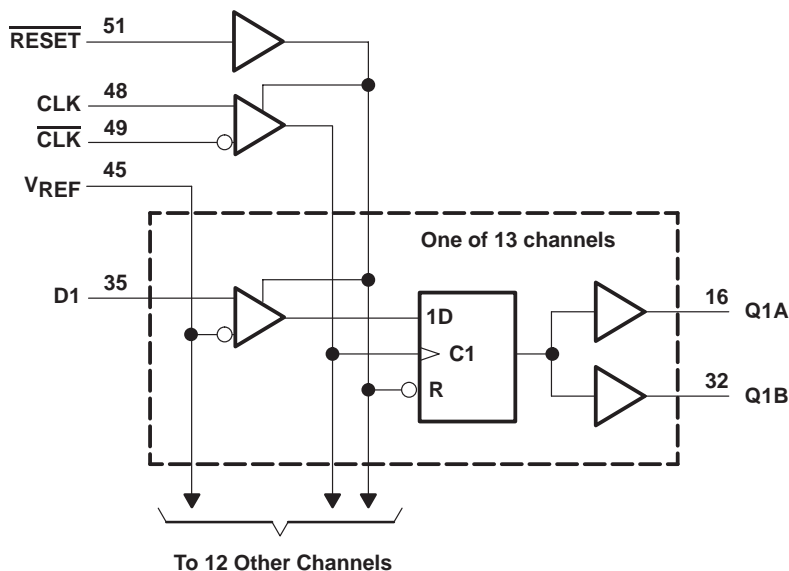

Pin numbers shown are for the DGG package.

absolute maximum ratings over operating free-air temperature range (unless otherwise noted)†

Supply voltage range, V_{CC} or V_{DDQ}	-0.5 V to 3.6 V
Input voltage range, V_I (see Notes 1 and 2)	-0.5 V to $V_{CC} + 0.5$ V
Output voltage range, V_O (see Notes 1 and 2)	-0.5 V to $V_{DDQ} + 0.5$ V
Input clamp current, I_{IK} ($V_I < 0$)	-50 mA
Output clamp current, I_{OK} ($V_O < 0$ or $V_O > V_{DDQ}$)	± 50 mA
Continuous output current, I_O ($V_O = 0$ to V_{DDQ})	± 50 mA
Continuous current through each V_{CC} , V_{DDQ} , or GND	± 100 mA
Package thermal impedance, θ_{JA} (see Note 3): DGG package	55°C/W
(see Note 4): RGQ package	22°C/W
Storage temperature range, T_{stg}	-65°C to 150°C

† Stresses beyond those listed under "absolute maximum ratings" may cause permanent damage to the device. These are stress ratings only, and functional operation of the device at these or any other conditions beyond those indicated under "recommended operating conditions" is not implied. Exposure to absolute-maximum-rated conditions for extended periods may affect device reliability.

- NOTES:
1. The input and output negative-voltage ratings may be exceeded if the input and output clamp-current ratings are observed.
 2. This value is limited to 3.6 V maximum.
 3. The package thermal impedance is calculated in accordance with JESD 51-7.
 4. The package thermal impedance is calculated in accordance with JESD 51-5.

SN74SSTV16859

13-BIT TO 26-BIT REGISTERED BUFFER WITH SSTL 2 INPUTS AND OUTPUTS

SCES297D – FEBRUARY 2000 – REVISED AUGUST 2004

recommended operating conditions (see Note 5)

		MIN	NOM	MAX	UNIT	
V _{CC}	Supply voltage	V _{DDQ}		2.7	V	
V _{DDQ}	Output supply voltage	2.3		2.7	V	
V _{REF}	Reference voltage (V _{REF} = V _{DDQ} /2)	1.15	1.25	1.35	V	
V _{TT}	Termination voltage	V _{REF} – 40 mV	V _{REF}	V _{REF} + 40 mV	V	
V _I	Input voltage	0		V _{CC}	V	
V _{IH}	AC high-level input voltage	Data inputs		V _{REF} + 310 mV	V	
V _{IL}	AC low-level input voltage	Data inputs		V _{REF} – 310 mV	V	
V _{IH}	DC high-level input voltage	Data inputs		V _{REF} + 150 mV	V	
V _{IL}	DC low-level input voltage	Data inputs		V _{REF} – 150 mV	V	
V _{IH}	High-level input voltage	RESET		1.7	V	
V _{IL}	Low-level input voltage	RESET		0.7	V	
V _{ICR}	Common-mode input voltage range	CLK, CLK		0.97	1.53	V
V _{I(PP)}	Peak-to-peak input voltage	CLK, CLK		360	mV	
I _{OH}	High-level output current			–20	mA	
I _{OL}	Low-level output current			20		
T _A	Operating free-air temperature	0		70	°C	

NOTE 5: The RESET input of the device must be held at valid logic voltage levels (not floating) to ensure proper device operation. The differential inputs must not be floating unless RESET is low. Refer to the TI application report, *Implications of Slow or Floating CMOS Inputs*, literature number SCBA004.

electrical characteristics over recommended operating free-air temperature range (unless otherwise noted)

PARAMETER		TEST CONDITIONS	V _{CC} †	MIN	TYP‡	MAX	UNIT
V _{IK}		I _I = –18 mA	2.3 V			–1.2	V
V _{OH}		I _{OH} = –100 μA	2.3 V to 2.7 V	V _{DDQ} – 0.2			V
		I _{OH} = –16 mA	2.3 V	1.95			
V _{OL}		I _{OL} = 100 μA	2.3 V to 2.7 V			0.2	V
		I _{OL} = 16 mA	2.3 V			0.35	
I _I	All inputs	V _I = V _{CC} or GND	2.7 V			±5	μA
I _{CC}	Static standby	RESET = GND	2.7 V			10	μA
	Static operating	RESET = V _{CC} , V _I = V _{IH(AC)} or V _{IL(AC)}				40	
I _{CCD}	Dynamic operating – clock only	RESET = V _{CC} , V _I = V _{IH(AC)} or V _{IL(AC)} , CLK and CLK switching 50% duty cycle	2.5 V			30	μA/ MHz
	Dynamic operating – per each data input	RESET = V _{CC} , V _I = V _{IH(AC)} or V _{IL(AC)} , CLK and CLK switching 50% duty cycle, One data input switching at one-half clock frequency, 50% duty cycle				10	
r _{OH}	Output high	I _{OH} = –20 mA	2.3 V to 2.7 V	7		20	Ω
r _{OL}	Output low	I _{OL} = 20 mA	2.3 V to 2.7 V	7		20	Ω
r _{O(Δ)}	r _{OH} – r _{OL}	I _O = 20 mA, T _A = 25°C, One output	2.5 V			6	Ω
C _i §	Data inputs	V _I = V _{REF} ± 310 mV	2.5 V	2.5	3	3.5	pF
	CLK, CLK	V _{ICR} = 1.25 V, V _{I(PP)} = 360 mV		2.5	3	3.5	
	RESET	V _I = V _{CC} or GND		3			

† For this test condition, V_{DDQ} always is equal to V_{CC}.

‡ All typical values are at V_{CC} = 2.5 V, T_A = 25°C.

§ Measured with 50-MHz input frequency for the QFN package and 10-MHz input frequency for the TSSOP package



SN74SSTV16859
13-BIT TO 26-BIT REGISTERED BUFFER
WITH SSTL 2 INPUTS AND OUTPUTS

SCES297D – FEBRUARY 2000 – REVISED AUGUST 2004

timing requirements over recommended operating free-air temperature range (unless otherwise noted) (see Figure 1)

		$V_{CC} = 2.5\text{ V}$ $\pm 0.2\text{ V}^\dagger$		UNIT
		MIN	MAX	
f_{clock}	Clock frequency	200		MHz
t_w	Pulse duration, CLK, $\overline{\text{CLK}}$ high or low	2.5		ns
t_{act}	Differential inputs active time (see Note 6)	22		ns
t_{inact}	Differential inputs inactive time (see Note 7)	22		ns
t_{su}	Setup time, fast slew rate (see Notes 8 and 10)	0.75		ns
	Setup time, slow slew rate (see Notes 9 and 10)	0.9		
t_h	Hold time, fast slew rate (see Notes 8 and 10)	0.75		ns
	Hold time, slow slew rate (see Notes 9 and 10)	0.9		

[†] For this test condition, V_{DDQ} always is equal to V_{CC} .

- NOTES:
6. V_{REF} must be held at a valid input level, and data inputs must be held low for a minimum time of t_{act} max, after $\overline{\text{RESET}}$ is taken high.
 7. V_{REF} , data, and clock inputs must be held at valid voltage levels (not floating) for a minimum time of t_{inact} max, after $\overline{\text{RESET}}$ is taken low.
 8. For data signal input slew rate $\geq 1\text{ V/ns}$
 9. For data signal input slew rate $\geq 0.5\text{ V/ns}$ and $< 1\text{ V/ns}$
 10. CLK, $\overline{\text{CLK}}$ signals input slew rates are $\geq 1\text{ V/ns}$.

switching characteristics over recommended operating free-air temperature range (unless otherwise noted) (see Figure 1)

PARAMETER	FROM (INPUT)	TO (OUTPUT)	$V_{CC} = 2.5\text{ V}$ $\pm 0.2\text{ V}^\dagger$		UNIT
			MIN	MAX	
f_{max}			200		MHz
t_{pd}	CLK and $\overline{\text{CLK}}$	Q	1.1	2.8	ns
t_{PHL}	$\overline{\text{RESET}}$	Q	5		ns

[†] For this test condition, V_{DDQ} always is equal to V_{CC} .

SN74SSTV16859
13-BIT TO 26-BIT REGISTERED BUFFER
WITH SSTL 2 INPUTS AND OUTPUTS

SCES297D – FEBRUARY 2000 – REVISED AUGUST 2004

PARAMETER MEASUREMENT INFORMATION

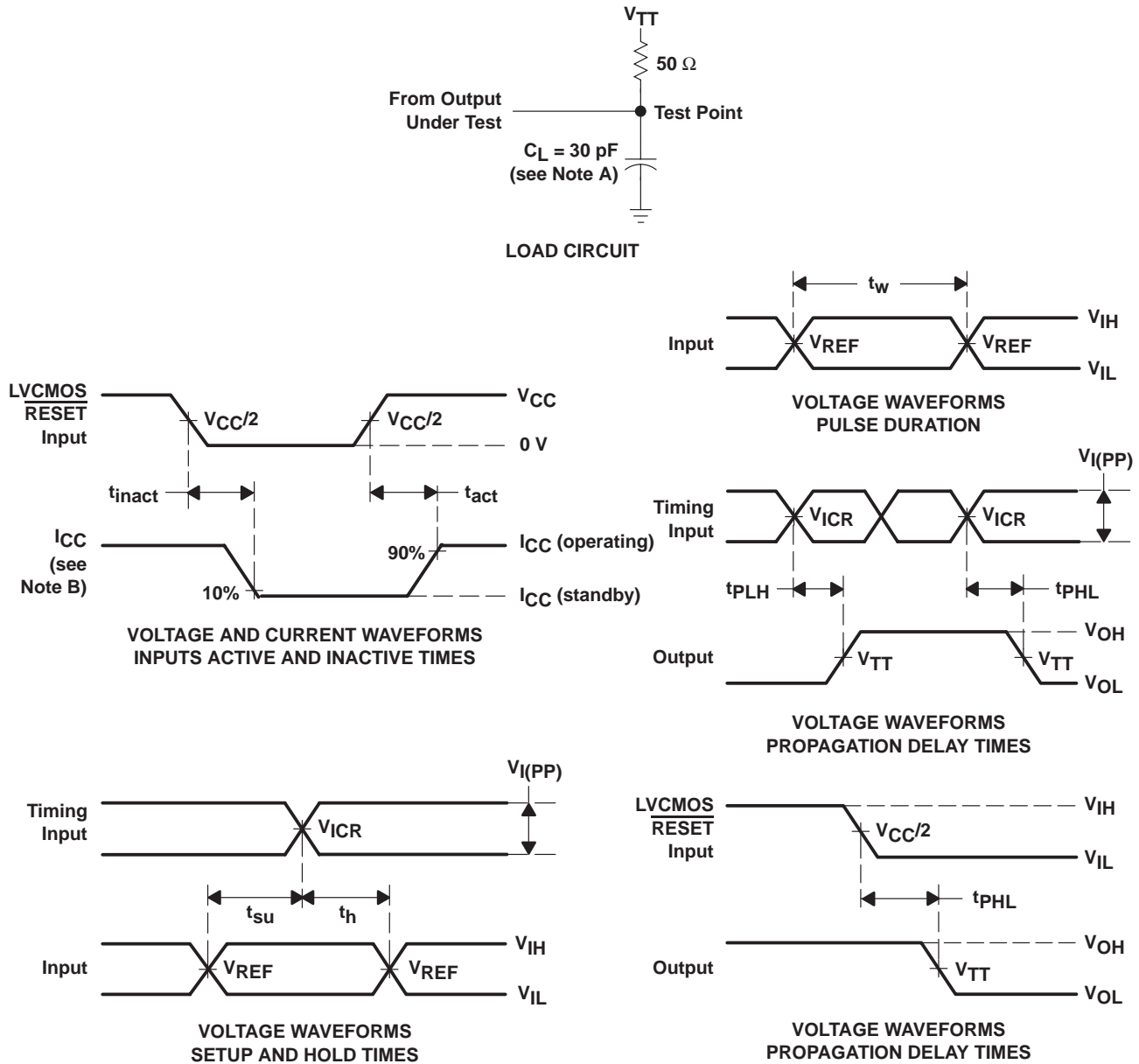

- NOTES:
- C_L includes probe and jig capacitance.
 - I_{CC} tested with clock and data inputs held at V_{CC} or GND, and I_O = 0 mA.
 - All input pulses are supplied by generators having the following characteristics: PRR ≤ 10 MHz, Z_O = 50 Ω, input slew rate = 1 V/ns ±20% (unless otherwise noted).
 - The outputs are measured one at a time, with one transition per measurement.
 - V_{TT} = V_{REF} = V_{DDQ}/2
 - V_{IH} = V_{REF} + 310 mV (ac voltage levels) for differential inputs. V_{IH} = V_{CC} for LVC MOS input.
 - V_{IL} = V_{REF} - 310 mV (ac voltage levels) for differential inputs. V_{IL} = GND for LVC MOS input.
 - t_{PLH} and t_{PHL} are the same as t_{pd}.

Figure 1. Load Circuit and Voltage Waveforms

PACKAGING INFORMATION

Orderable Device	Status ⁽¹⁾	Package Type	Package Drawing	Pins	Package Qty	Eco Plan ⁽²⁾	Lead/Ball Finish	MSL Peak Temp ⁽³⁾
74SSTV16859DGGRG4	ACTIVE	TSSOP	DGG	64	2000	Green (RoHS & no Sb/Br)	CU NIPDAU	Level-2-260C-1 YEAR
74SSTV16859RGQ8G3	ACTIVE	VQFN	RGQ	56	2000	Green (RoHS & no Sb/Br)	CU SN	Level-3-260C-168 HR
SN74SSTV16859DGG	OBSOLETE	TSSOP	DGG	64		TBD	Call TI	Call TI
SN74SSTV16859DGGG4	OBSOLETE	TSSOP	DGG	64		TBD	Call TI	Call TI
SN74SSTV16859DGGR	ACTIVE	TSSOP	DGG	64	2000	Green (RoHS & no Sb/Br)	CU NIPDAU	Level-2-260C-1 YEAR
SN74SSTV16859RGQ8	ACTIVE	VQFN	RGQ	56	2000	Green (RoHS & no Sb/Br)	CU SN	Level-3-260C-168 HR
SN74SSTV16859RGQR	ACTIVE	VQFN	RGQ	56	2000	TBD	CU SNPB	Level-3-235C-168 HR

⁽¹⁾ The marketing status values are defined as follows:

ACTIVE: Product device recommended for new designs.

LIFEBUY: TI has announced that the device will be discontinued, and a lifetime-buy period is in effect.

NRND: Not recommended for new designs. Device is in production to support existing customers, but TI does not recommend using this part in a new design.

PREVIEW: Device has been announced but is not in production. Samples may or may not be available.

OBSOLETE: TI has discontinued the production of the device.

⁽²⁾ Eco Plan - The planned eco-friendly classification: Pb-Free (RoHS), Pb-Free (RoHS Exempt), or Green (RoHS & no Sb/Br) - please check <http://www.ti.com/productcontent> for the latest availability information and additional product content details.

TBD: The Pb-Free/Green conversion plan has not been defined.

Pb-Free (RoHS): TI's terms "Lead-Free" or "Pb-Free" mean semiconductor products that are compatible with the current RoHS requirements for all 6 substances, including the requirement that lead not exceed 0.1% by weight in homogeneous materials. Where designed to be soldered at high temperatures, TI Pb-Free products are suitable for use in specified lead-free processes.

Pb-Free (RoHS Exempt): This component has a RoHS exemption for either 1) lead-based flip-chip solder bumps used between the die and package, or 2) lead-based die adhesive used between the die and leadframe. The component is otherwise considered Pb-Free (RoHS compatible) as defined above.

Green (RoHS & no Sb/Br): TI defines "Green" to mean Pb-Free (RoHS compatible), and free of Bromine (Br) and Antimony (Sb) based flame retardants (Br or Sb do not exceed 0.1% by weight in homogeneous material)

⁽³⁾ MSL, Peak Temp. -- The Moisture Sensitivity Level rating according to the JEDEC industry standard classifications, and peak solder temperature.

Important Information and Disclaimer: The information provided on this page represents TI's knowledge and belief as of the date that it is provided. TI bases its knowledge and belief on information provided by third parties, and makes no representation or warranty as to the accuracy of such information. Efforts are underway to better integrate information from third parties. TI has taken and continues to take reasonable steps to provide representative and accurate information but may not have conducted destructive testing or chemical analysis on incoming materials and chemicals. TI and TI suppliers consider certain information to be proprietary, and thus CAS numbers and other limited information may not be available for release.

In no event shall TI's liability arising out of such information exceed the total purchase price of the TI part(s) at issue in this document sold by TI to Customer on an annual basis.

TAPE AND REEL INFORMATION



QUADRANT ASSIGNMENTS FOR PIN 1 ORIENTATION IN TAPE



*All dimensions are nominal

Device	Package Type	Package Drawing	Pins	SPQ	Reel Diameter (mm)	Reel Width W1 (mm)	A0 (mm)	B0 (mm)	K0 (mm)	P1 (mm)	W (mm)	Pin1 Quadrant
SN74SSTV16859DGGR	TSSOP	DGG	64	2000	330.0	24.4	8.4	17.3	1.7	12.0	24.0	Q1

TAPE AND REEL BOX DIMENSIONS



*All dimensions are nominal

Device	Package Type	Package Drawing	Pins	SPQ	Length (mm)	Width (mm)	Height (mm)
SN74SSTV16859DGGR	TSSOP	DGG	64	2000	346.0	346.0	41.0

RGQ (S-PVQFN-N56)

PLASTIC QUAD FLATPACK NO-LEAD

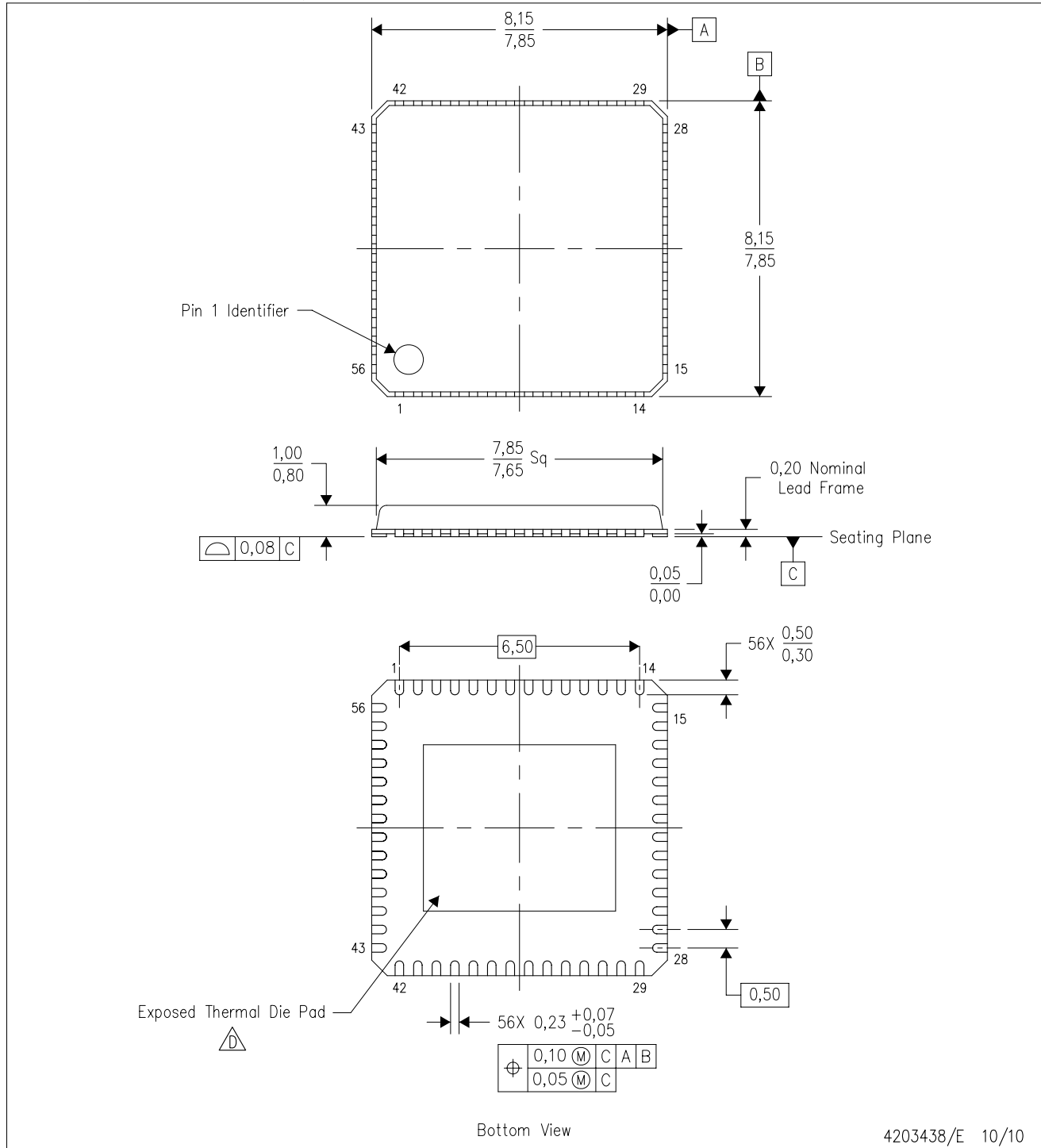

4203438/E 10/10

- NOTES:
- A. All linear dimensions are in millimeters. Dimensioning and tolerancing per ASME Y14.5M-1994.
 - B. This drawing is subject to change without notice.
 - C. QFN (Quad Flatpack No-Lead) Package configuration.
 -  The package thermal pad must be soldered to the board for thermal and mechanical performance. See the Product Data Sheet for details regarding the exposed thermal pad dimensions.
 - E. Package complies to JEDEC MO-220 variation VLLD-2.

THERMAL PAD MECHANICAL DATA

RGQ (S-PVQFN-N56)

PLASTIC QUAD FLATPACK NO-LEAD

THERMAL INFORMATION

This package incorporates an exposed thermal pad that is designed to be attached directly to an external heatsink. The thermal pad must be soldered directly to the printed circuit board (PCB). After soldering, the PCB can be used as a heatsink. In addition, through the use of thermal vias, the thermal pad can be attached directly to the appropriate copper plane shown in the electrical schematic for the device, or alternatively, can be attached to a special heatsink structure designed into the PCB. This design optimizes the heat transfer from the integrated circuit (IC).

For information on the Quad Flatpack No-Lead (QFN) package and its advantages, refer to Application Report, QFN/SON PCB Attachment, Texas Instruments Literature No. SLUA271. This document is available at www.ti.com.

The exposed thermal pad dimensions for this package are shown in the following illustration.

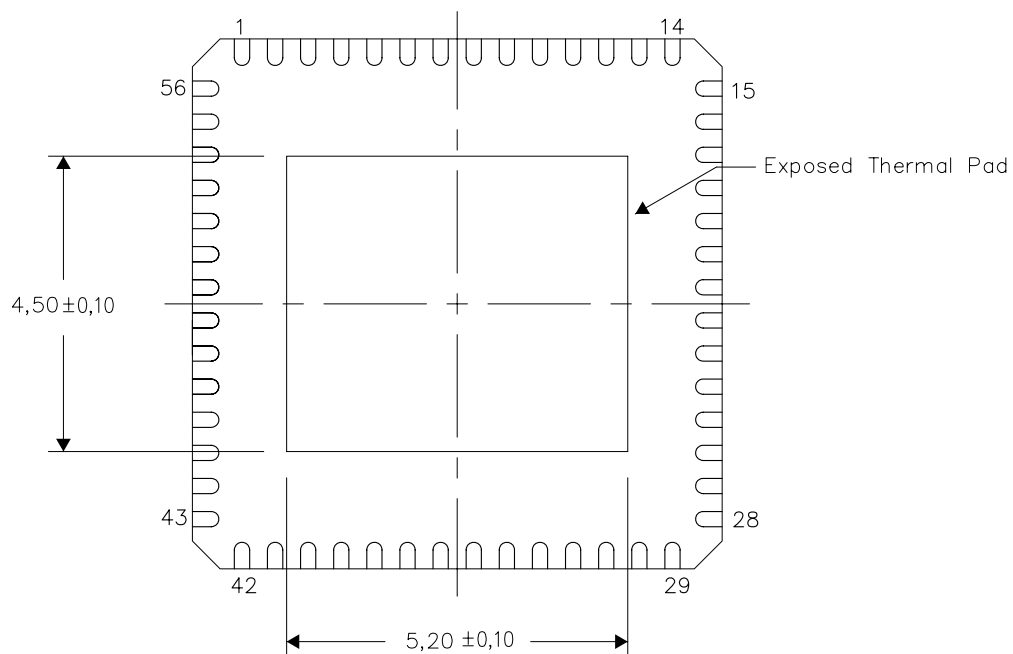

Bottom View

Exposed Thermal Pad Dimensions

4206347/D 12/10

NOTE: A. All linear dimensions are in millimeters

RGQ (S-PVQFN-N56)

PLASTIC QUAD FLATPACK NO-LEAD

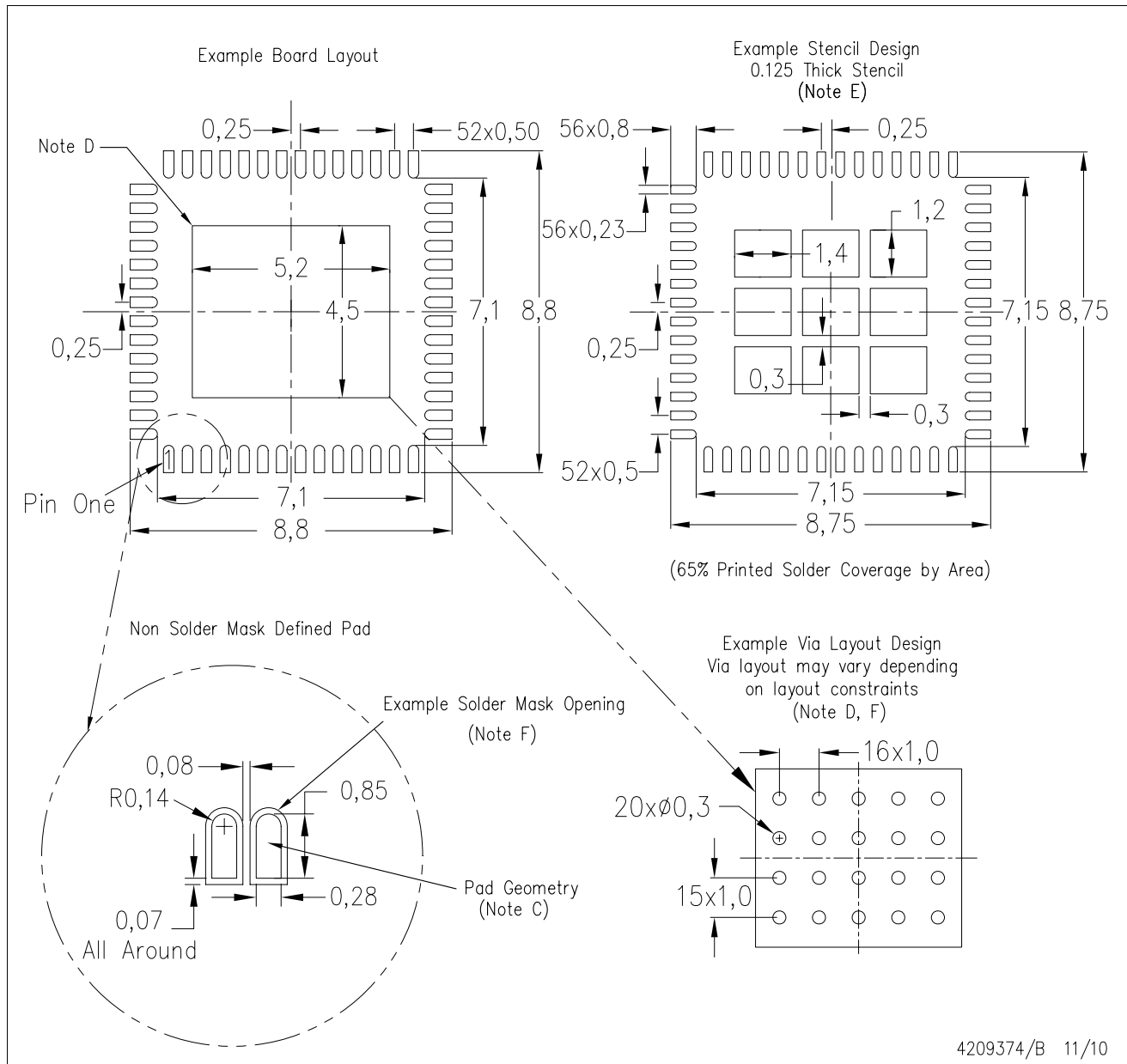

- NOTES:
- A. All linear dimensions are in millimeters.
 - B. This drawing is subject to change without notice.
 - C. Publication IPC-SM-782 is recommended for alternate designs.
 - D. This package is designed to be soldered to a thermal pad on the board. Refer to Application Note, Quad Flat-Pack Packages, Texas Instruments Literature No. SLUA271, and also the Product Data Sheets for specific thermal information, via requirements, and recommended board layout. These documents are available at www.ti.com <<http://www.ti.com>>.
 - E. Laser cutting apertures with trapezoidal walls and also rounding corners will offer better paste release. Customers should contact their board assembly site for stencil design recommendations. Refer to IPC 7525 for stencil design considerations.
 - F. Customers should contact their board fabrication site for recommended solder mask tolerances and via tenting recommendations for vias placed in the thermal pad.

DGG (R-PDSO-G**)

PLASTIC SMALL-OUTLINE PACKAGE

48 PINS SHOWN



- NOTES: A. All linear dimensions are in millimeters.
 B. This drawing is subject to change without notice.
 C. Body dimensions do not include mold protrusion not to exceed 0,15.
 D. Falls within JEDEC MO-153

IMPORTANT NOTICE

Texas Instruments Incorporated and its subsidiaries (TI) reserve the right to make corrections, modifications, enhancements, improvements, and other changes to its products and services at any time and to discontinue any product or service without notice. Customers should obtain the latest relevant information before placing orders and should verify that such information is current and complete. All products are sold subject to TI's terms and conditions of sale supplied at the time of order acknowledgment.

TI warrants performance of its hardware products to the specifications applicable at the time of sale in accordance with TI's standard warranty. Testing and other quality control techniques are used to the extent TI deems necessary to support this warranty. Except where mandated by government requirements, testing of all parameters of each product is not necessarily performed.

TI assumes no liability for applications assistance or customer product design. Customers are responsible for their products and applications using TI components. To minimize the risks associated with customer products and applications, customers should provide adequate design and operating safeguards.

TI does not warrant or represent that any license, either express or implied, is granted under any TI patent right, copyright, mask work right, or other TI intellectual property right relating to any combination, machine, or process in which TI products or services are used. Information published by TI regarding third-party products or services does not constitute a license from TI to use such products or services or a warranty or endorsement thereof. Use of such information may require a license from a third party under the patents or other intellectual property of the third party, or a license from TI under the patents or other intellectual property of TI.

Reproduction of TI information in TI data books or data sheets is permissible only if reproduction is without alteration and is accompanied by all associated warranties, conditions, limitations, and notices. Reproduction of this information with alteration is an unfair and deceptive business practice. TI is not responsible or liable for such altered documentation. Information of third parties may be subject to additional restrictions.

Resale of TI products or services with statements different from or beyond the parameters stated by TI for that product or service voids all express and any implied warranties for the associated TI product or service and is an unfair and deceptive business practice. TI is not responsible or liable for any such statements.

TI products are not authorized for use in safety-critical applications (such as life support) where a failure of the TI product would reasonably be expected to cause severe personal injury or death, unless officers of the parties have executed an agreement specifically governing such use. Buyers represent that they have all necessary expertise in the safety and regulatory ramifications of their applications, and acknowledge and agree that they are solely responsible for all legal, regulatory and safety-related requirements concerning their products and any use of TI products in such safety-critical applications, notwithstanding any applications-related information or support that may be provided by TI. Further, Buyers must fully indemnify TI and its representatives against any damages arising out of the use of TI products in such safety-critical applications.

TI products are neither designed nor intended for use in military/aerospace applications or environments unless the TI products are specifically designated by TI as military-grade or "enhanced plastic." Only products designated by TI as military-grade meet military specifications. Buyers acknowledge and agree that any such use of TI products which TI has not designated as military-grade is solely at the Buyer's risk, and that they are solely responsible for compliance with all legal and regulatory requirements in connection with such use.

TI products are neither designed nor intended for use in automotive applications or environments unless the specific TI products are designated by TI as compliant with ISO/TS 16949 requirements. Buyers acknowledge and agree that, if they use any non-designated products in automotive applications, TI will not be responsible for any failure to meet such requirements.

Following are URLs where you can obtain information on other Texas Instruments products and application solutions:

Products

Audio	www.ti.com/audio
Amplifiers	amplifier.ti.com
Data Converters	dataconverter.ti.com
DLP® Products	www.dlp.com
DSP	dsp.ti.com
Clocks and Timers	www.ti.com/clocks
Interface	interface.ti.com
Logic	logic.ti.com
Power Mgmt	power.ti.com
Microcontrollers	microcontroller.ti.com
RFID	www.ti-rfid.com
RF/IF and ZigBee® Solutions	www.ti.com/lprf

Applications

Communications and Telecom	www.ti.com/communications
Computers and Peripherals	www.ti.com/computers
Consumer Electronics	www.ti.com/consumer-apps
Energy and Lighting	www.ti.com/energy
Industrial	www.ti.com/industrial
Medical	www.ti.com/medical
Security	www.ti.com/security
Space, Avionics and Defense	www.ti.com/space-avionics-defense
Transportation and Automotive	www.ti.com/automotive
Video and Imaging	www.ti.com/video
Wireless	www.ti.com/wireless-apps

TI E2E Community Home Page

e2e.ti.com

Mailing Address: Texas Instruments, Post Office Box 655303, Dallas, Texas 75265
Copyright © 2011, Texas Instruments Incorporated