

FEATURES

Lowest Cost 10-Bit DAC
 Low Cost AD7520 Replacement
 Linearity: 1/2, 1 or 2LSB
 Low Power Dissipation
 Full Four-Quadrant Multiplying DAC
 CMOS/TTL Direct Interface
 Latch Free (Protection Schottky Not Required)
 End-Point Linearity

APPLICATIONS

Digitally Controlled Attenuators
 Programmable Gain Amplifiers
 Function Generation
 Linear Automatic Gain Control

GENERAL DESCRIPTION

The AD7533 is a low cost 10-bit 4-quadrant multiplying DAC manufactured using an advanced thin-film-on-monolithic-CMOS wafer fabrication process.

Pin and function equivalent to the industry standard AD7520, the AD7533 is recommended as a lower cost alternative for old AD7520 sockets or new 10-bit DAC designs.

AD7533 application flexibility is demonstrated by its ability to interface to TTL or CMOS, operate on +5V to +15V power, and provide proper binary scaling for reference inputs of either positive or negative polarity.

FUNCTIONAL BLOCK DIAGRAM

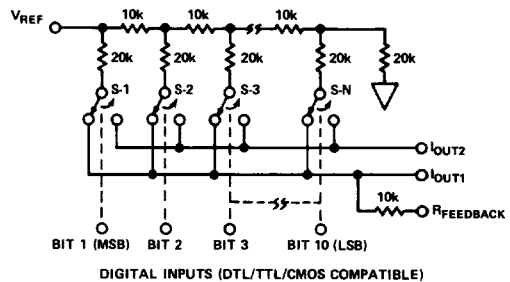

Logic: A switch is closed to I_{OUT1} for its digital input in a "HIGH" state.

ORDERING GUIDE¹

Model ²	Temperature Range	Nonlinearity (% FSR max)	Package Option ³
AD7533JN	-40°C to +85°C	± 0.2	N-16
AD7533KN	-40°C to +85°C	± 0.1	N-16
AD7533LN	-40°C to +85°C	± 0.05	N-16
AD7533JP	-40°C to +85°C	± 0.2	P-20A
AD7533KP	-40°C to +85°C	± 0.1	P-20A
AD7533LP	-40°C to +85°C	± 0.05	P-20A
AD7533JR	-40°C to +85°C	± 0.2	R-16
AD7533KR	-40°C to +85°C	± 0.1	R-16
AD7533LR	-40°C to +85°C	± 0.05	R-16
AD7533AQ	-40°C to +85°C	± 0.2	Q-16
AD7533BQ	-40°C to +85°C	± 0.1	Q-16
AD7533CQ	-40°C to +85°C	± 0.05	Q-16
AD7533SQ	-55°C to +125°C	± 0.2	Q-16
AD7533TQ	-55°C to +125°C	± 0.1	Q-16
AD7533UQ	-55°C to +125°C	± 0.05	Q-16
AD7533SE	-55°C to +125°C	± 0.2	E-20A
AD7533TE	-55°C to +125°C	± 0.1	E-20A
AD7533UE	-55°C to +125°C	± 0.05	E-20A

NOTES

¹Analog Devices reserves the right to ship ceramic (package outline D-16) packages in lieu of cerdip (package outline Q-16) packages.

²To order MIL-STD-883, Class B processed parts, add /883B to part number. Contact your local sales office for military data sheet.

³E = Leadless Ceramic Chip Carrier; N = Plastic DIP; P = Plastic Leaded Chip Carrier; Q = Cerdip; R = SOIC. For outline information see Package Information section.

AD7533—SPECIFICATIONS ($V_{DD} = +15V$, $V_{OUT1} = V_{OUT2} = 0V$; $V_{REF} = +10V$ unless otherwise noted)

Parameter	$T_A = 25^\circ\text{C}$	$T_A = \text{Operating Range}$	Test Conditions
STATIC ACCURACY			
Resolution	10 Bits	10 Bits	
Relative Accuracy ¹			
AD7533J, A, S Versions	$\pm 0.2\%$ FSR max	$\pm 0.2\%$ FSR max	Digital Inputs = V_{INH}
AD7533K, B, T Versions	$\pm 0.1\%$ FSR max	$\pm 0.1\%$ FSR max	
AD7533L, C, U Versions	$\pm 0.05\%$ FSR max	$\pm 0.05\%$ FSR max	
Gain Error ^{2,3}	$\pm 1.4\%$ FS max	$\pm 1.5\%$ FS max	
Supply Rejection ⁴			Digital Inputs = V_{INH} ; $V_{DD} = +14V$ to $+17V$
$\Delta\text{Gain}/\Delta V_{DD}$	0.005%/%	0.008%/%	
Output Leakage Current			Digital Inputs = V_{INH} ; $V_{REF} = \pm 10V$
I_{OUT1}	$\pm 50\text{nA}$ max	$\pm 200\text{nA}$ max	Digital Inputs = V_{INL} ; $V_{REF} = \pm 10V$
I_{OUT2}	$\pm 50\text{nA}$ max	$\pm 200\text{nA}$ max	Digital Inputs = V_{INH} ; $V_{REF} = \pm 10V$
DYNAMIC ACCURACY			
Output Current Settling Time	600ns max ⁴	800ns ⁵	To 0.05% FSR; $R_{LOAD} = 100\Omega$; Digital Inputs = V_{INH} to V_{INL} or V_{INL} to V_{INH}
Feedthrough Error	$\pm 0.05\%$ FSR max ⁵	$\pm 0.1\%$ FSR max ⁵	Digital Inputs = V_{INL} ; $V_{REF} = \pm 10V$, 100kHz sine wave.
REFERENCE INPUT			
Input Resistance (Pin 15)	5k Ω min, 20k Ω max	5k Ω min, 20k Ω max ⁶	
ANALOG OUTPUTS			
Output Capacitance			
C_{OUT1}	100pF max ⁵	100pF max ⁵	Digital Inputs = V_{INH}
C_{OUT2}	35pF max ⁵	35pF max ⁵	
C_{OUT1}	35pF max ⁵	35pF max ⁵	Digital Inputs = V_{INL}
C_{OUT2}	100pF max ⁵	100pF max ⁵	
DIGITAL INPUTS			
Input High Voltage			
V_{INH}	2.4V min	2.4V min	
Input Low Voltage			
V_{INL}	0.8V max	0.8V max	
Input Leakage Current			
I_{IN}	$\pm 1\mu\text{A}$ max	$\pm 1\mu\text{A}$ max	$V_{IN} = 0V$ and V_{DD}
Input Capacitance			
C_{IN}	8pF max ⁵	8pF max ⁵	
POWER REQUIREMENTS			
V_{DD}	$+15V \pm 10\%$	$+15V \pm 10\%$	Rated Accuracy
V_{DD} Range ⁵	+5V to +16V	+5V to +16V	Functionality with Degraded Performance
I_{DD}	2mA max	2mA max	Digital Inputs = V_{INL} or V_{INH}

NOTES

¹"FSR" is Full-Scale Range.

²Full Scale (FS) = (V_{REF})

³Max gain change from $T_A = +25^\circ\text{C}$ to T_{min} or T_{max} is $\pm 0.1\%$ FSR.

⁴AC parameter, sample tested to ensure specification compliance.

⁵Guaranteed, not tested.

⁶Absolute temperature coefficient is approximately $-300\text{ppm}/^\circ\text{C}$.

Specifications subject to change without notice.

ABSOLUTE MAXIMUM RATINGS*

(T_A = +25°C unless otherwise noted)

V _{DD} to GND	−0.3V, +17V
R _{FB} to GND	±25V
V _{REF} to GND	±25V
Digital Input Voltage Range	−0.3V to V _{DD} +0.3V
OUT 1, OUT 2 to GND	−0.3V to V _{DD} +0.3V
Power Dissipation (Any Package)	
To +75°C	450mW
Derates above +75°C by	6mW/°C

Operating Temperature Range

Commercial (J, K, L Versions)	−40°C to +85°C
Industrial (A, B, C Versions)	−40°C to +85°C
Extended (S, T, U Versions)	−55°C to +125°C
Storage Temperature	−65°C to +150°C
Lead Temperature (Soldering, 10sec)	+300°C

*Stresses above those listed under “Absolute Maximum Ratings” may cause permanent damage to the device. This is a stress rating only and functional operation of the device at these or any other conditions above those indicated in the operational sections of this specification is not implied. Exposure to absolute maximum rating conditions for extended periods may affect device reliability.

CAUTION

ESD (electrostatic discharge) sensitive device. The digital control inputs are diode protected; however, permanent damage may occur on unconnected devices subject to high energy electrostatic fields. Unused devices must be stored in conductive foam or shunts. The protective foam should be discharged to the destination socket before devices are removed.



TERMINOLOGY

RELATIVE ACCURACY: Relative accuracy or end-point nonlinearity is a measure of the maximum deviation from a straight line passing through the endpoints of the DAC transfer function. It is measured after adjusting for ideal zero and full scale and is expressed in % of full-scale range or (sub) multiples of 1LSB.

RESOLUTION: Value of the LSB. For example, a unipolar converter with n bits has a resolution of $(2^{-n}) (V_{REF})$. A bipolar converter of n bits has a resolution of $[2^{-(n-1)}] (V_{REF})$. Resolution in no way implies linearity.

SETTLING TIME: Time required for the output function of the DAC to settle to within 1/2LSB for a given digital input stimulus, i.e., 0 to Full Scale.

GAIN ERROR: Gain error is a measure of the output error between an ideal DAC and the actual device output. It is measured with all 1s in the DAC after offset error has been adjusted out and is expressed in Least Significant Bits. Gain error is adjustable to zero with an external potentiometer.

FEEDTHROUGH ERROR: Error caused by capacitive coupling from V_{REF} to output with all switches OFF.

OUTPUT CAPACITANCE: Capacity from I_{OUT1} and I_{OUT2} terminals to ground.

OUTPUT LEAKAGE CURRENT: Current which appears on I_{OUT1} terminal with all digital inputs LOW or on I_{OUT2} terminal when all inputs are HIGH.

PIN CONFIGURATIONS

DIP, SOIC

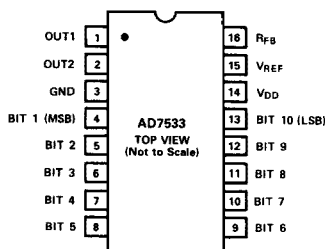

LCCC

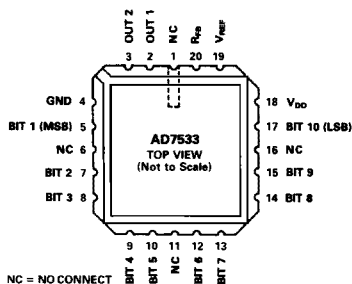

PLCC

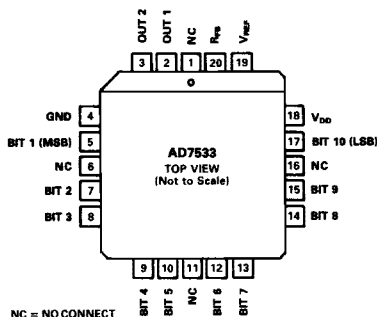

AD7533

CIRCUIT DESCRIPTION

GENERAL CIRCUIT INFORMATION

The AD7533, a 10-bit multiplying D/A converter, consists of a highly stable thin film R-2R ladder and ten CMOS current switches on a monolithic chip. Most applications require the addition of only an output operational amplifier and a voltage or current reference.

The simplified D/A circuit is shown in Figure 1. An inverted R-2R ladder structure is used – that is, the binary weighted currents are switched between the I_{OUT1} and I_{OUT2} bus lines, thus maintaining a constant current in each ladder leg independent of the switch state.

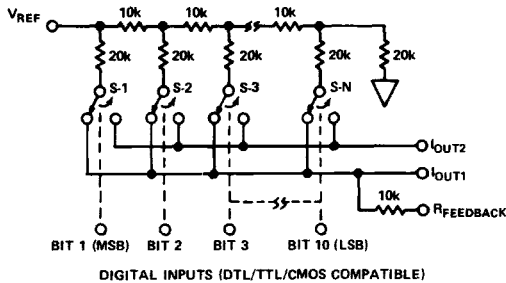

Figure 1. AD7533 Functional Diagram

One of the CMOS current switches is shown in Figure 2. The geometries of devices 1, 2 and 3 are optimized to make the digital control inputs DTL/TTL/CMOS compatible over the full military temperature range. The input stage drives two inverters (devices 4, 5, 6 and 7) which in turn drive the two output N channels. The “ON” resistances of the switches are binarily sealed so the voltage drop across each switch is the same. For example, switch 1 of Figure 2 was designed for an “ON” resistance of 20 Ω , switch 2 for 40 Ω , and so on. For a 10V reference input, the current through switch 1 is 0.5mA, the current through switch 2 is 0.25mA, and so on, thus maintaining a constant 10mV drop across each switch. It is essential that each switch voltage drop be equal if the binarily weighted current division property of the ladder is to be maintained.

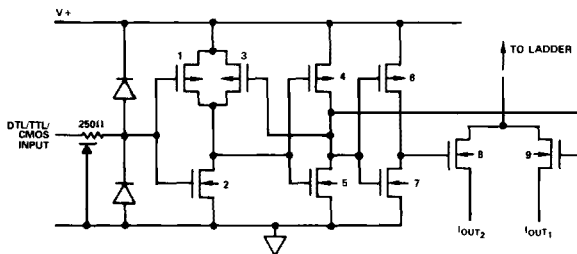

Figure 2. CMOS Switch

EQUIVALENT CIRCUIT ANALYSIS

The equivalent circuits for all digital inputs high and all digital inputs low are shown in Figures 3 and 4. In Figure 3 with all digital inputs low, the reference current is switched to I_{OUT2}. The current source I_{LEAKAGE} is composed of surface and junction leakages to the substrate while the $\frac{I}{1024}$ current source represents a constant 1-bit current drain through the termination resistor on the R-2R ladder. The “ON” capacitance of the output N channel switch is 100pF, as shown on the I_{OUT2} terminal. The “OFF” switch capacitance is 35pF, as shown on the I_{OUT1} terminal. Analysis of the circuit for all digital inputs high, as shown in Figure 4, is similar to Figure 3; however, the “ON” switches are now on terminal I_{OUT1}, hence the 100pF at that terminal.

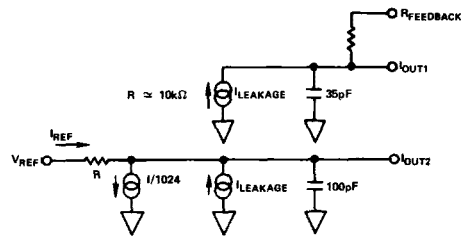

Figure 3. AD7533 Equivalent Circuit – All Digital Inputs Low

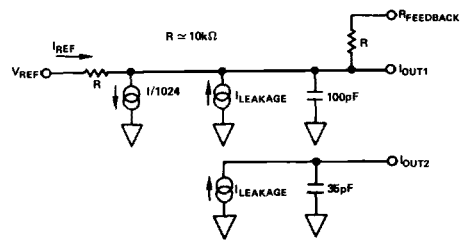

Figure 4. AD7533 Equivalent Circuit – All Digital Inputs High

OPERATION

**UNIPOLAR BINARY OPERATION
(2-QUADRANT MULTIPLICATION)**

DIGITAL INPUT MSB	LSB	ANALOG OUTPUT (V_{OUT} as shown in Figure 5)
1	1	$-V_{REF} \left(\frac{1023}{1024} \right)$
1	0	$-V_{REF} \left(\frac{513}{1024} \right)$
1	0	$-V_{REF} \left(\frac{512}{1024} \right) = \frac{V_{REF}}{2}$
0	1	$-V_{REF} \left(\frac{511}{1024} \right)$
0	0	$-V_{REF} \left(\frac{1}{1024} \right)$
0	0	$-V_{REF} \left(\frac{0}{1024} \right) = 0$

NOTE:

1. Nominal LSB magnitude for the circuit of

Figure 5 is given by $LSB = V_{REF} \left(\frac{1}{1024} \right)$

Table I. Unipolar Binary Code Table

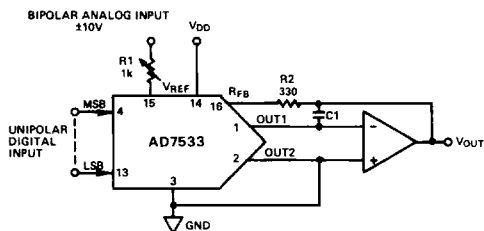

NOTES:

1. R1 AND R2 USED ONLY IF GAIN ADJUSTMENT IS REQUIRED.
2. C1 PHASE COMPENSATION (5 - 15pF) MAY BE REQUIRED WHEN USING HIGH SPEED AMPLIFIERS.

Figure 5. Unipolar Binary Operation (2-Quadrant Multiplication)

**BIPOLAR OPERATION
(4-QUADRANT MULTIPLICATION)**

DIGITAL INPUT MSB	LSB	ANALOG OUTPUT (V_{OUT} as shown in Figure 6)
1	1	$+V_{REF} \left(\frac{511}{512} \right)$
1	0	$+V_{REF} \left(\frac{1}{512} \right)$
1	0	0
0	1	$-V_{REF} \left(\frac{1}{512} \right)$
0	0	$-V_{REF} \left(\frac{511}{512} \right)$
0	0	$-V_{REF} \left(\frac{512}{1024} \right)$

NOTE

1. Nominal LSB magnitude for the circuit of

Figure 6 is given by $LSB = V_{REF} \left(\frac{1}{512} \right)$

Table II. Bipolar (Offset Binary) Code Table

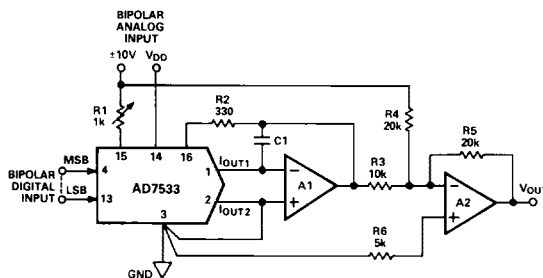

NOTES:

1. R3, R4 AND R5 SELECTED FOR MATCHING AND TRACKING.
2. R1, R2 USED ONLY IF GAIN ADJUSTMENT IS REQUIRED.
3. C1 PHASE COMPENSATION (5 - 15pF) MAY BE REQUIRED WHEN USING HIGH SPEED AMPLIFIERS.

Figure 6. Bipolar Operation (4-Quadrant Multiplication)

AD7533

APPLICATIONS

10-BIT AND SIGN MULTIPLYING DAC

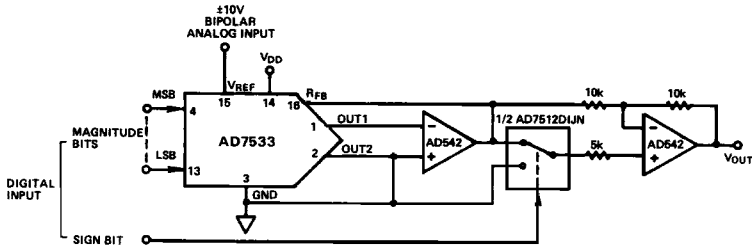

PROGRAMMABLE FUNCTION GENERATOR

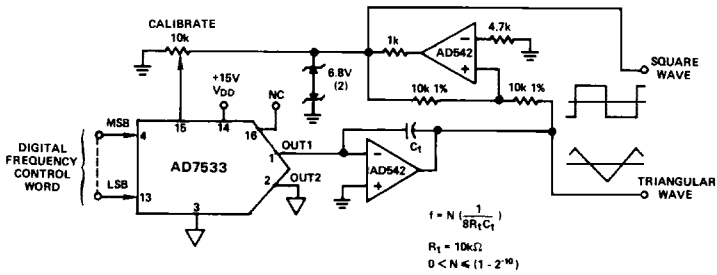

DIVIDER (DIGITALLY CONTROLLED GAIN)

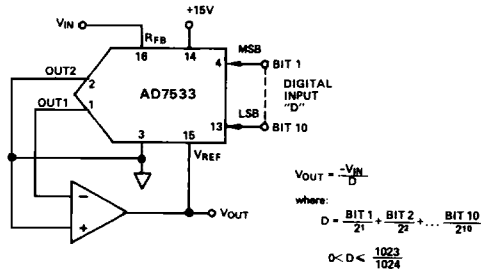

MODIFIED SCALE FACTOR AND OFFSET

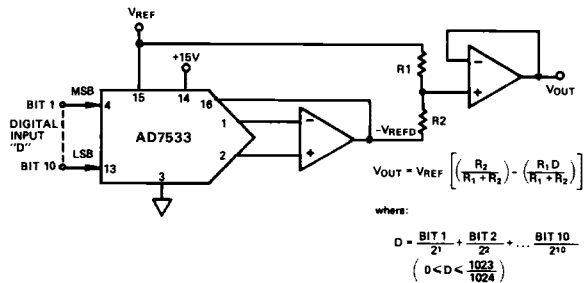

DIGITALLY PROGRAMMABLE LIMIT DETECTOR

