

PWM Control 2A Step-Down Converter

■ Features

- Input voltage: 3.6V to 23V.
- Output voltage: 0.8V to V_{CC} .
- Duty ratio: 0% to 100% PWM control
- Oscillation frequency: 300KHz typ.
- Soft-start, Current Limit, Enable function
- Thermal Shutdown function
- Built-in internal SW P-channel MOS
- SOP-8L **Pb-Free** Package.

■ Applications

- PC Motherboard
- LCD Monitor
- Graphic Card
- DVD-Video Player
- Telecom Equipment
- ADSL Modem
- Printer and other Peripheral Equipment
- Microprocessor core supply
- Networking power supply

■ Pin Assignments

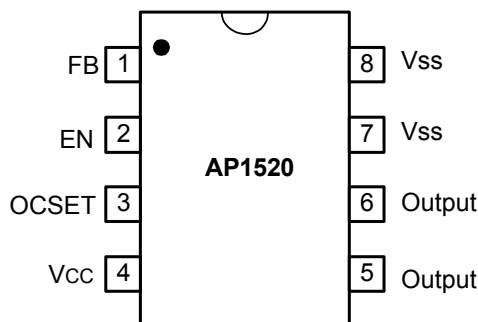

■ General Description

AP1520 consists of step-down switching regulator with PWM control. These devices include a reference voltage source, oscillation circuit, error amplifier, internal PMOS and etc.

AP1520 provides low-ripple power, high efficiency, and excellent transient characteristics. The PWM control circuit is able to vary the duty ratio linearly from 0 up to 100%. This converter also contains an error amplifier circuit as well as a soft-start circuit that prevents overshoot at startup. An enable function, an over current protect function and a short circuit protect function are built inside, and when OCP or SCP happens, the operation frequency will be reduced from 300KHz to 30KHz. Also, an internal compensation block is built in to minimum external component count.

With the addition of an internal P-channel Power MOS, a coil, capacitors, and a diode connected externally, these ICs can function as step-down switching regulators. They serve as ideal power supply units for portable devices when coupled with the SOP-8L mini-package, providing such outstanding features as low current consumption. Since this converter can accommodate an input voltage up to 23V, it is also suitable for the operation via an AC adapter.

■ Pin Descriptions

Name	Pin	Description
FB	1	Feedback pin.
EN	2	Power-off pin H: Normal operation (Step-down operation) L: Step-down operation stopped (All circuits deactivated)
OCSET	3	Add an external resistor to set max output current.
Vcc	4	IC power supply pin
Output	5 · 6	Switch Pin. Connect external inductor/diode here. Minimize trace area at this pin to reduce EMI.
Vss	7 · 8	GND Pin

PWM Control 2A Step-Down Converter

■ Ordering Information

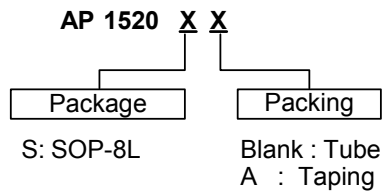

■ Block Diagram

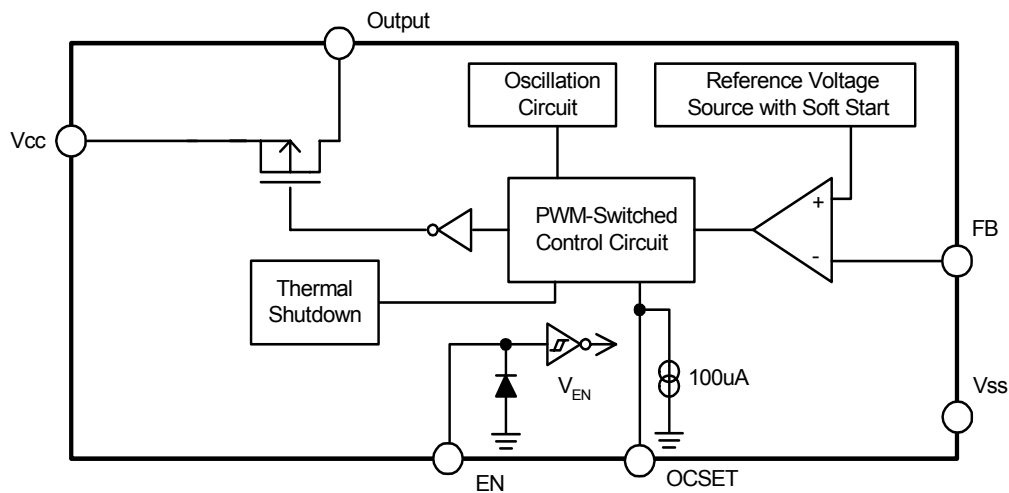

■ Absolute Maximum Ratings

Symbol	Parameter	Rating	Unit
V_{CC}	V_{CC} Pin Voltage	$V_{SS} - 0.3$ to $V_{SS} + 25$	V
V_{FB}	Feedback Pin Voltage	$V_{SS} - 0.3$ to V_{CC}	V
V_{EN}	EN Pin Voltage	$V_{SS} - 0.3$ to $V_{IN} + 0.3$	V
V_{OUTPUT}	Switch Pin Voltage	$V_{SS} - 0.3$ to $V_{IN} + 0.3$	V
P_D	Power Dissipation	Internally limited	mW
T_{OPR}	Operating Temperature Range	-20 to +125	°C
T_{STG}	Storage Temperature Range	-40 to +150	°C

Caution: The absolute maximum ratings are rated values exceeding which the product could suffer physical damage. These values must therefore not be exceeded under any conditions.

PWM Control 2A Step-Down Converter

■ Electrical Characteristics ($V_{IN} = 12V$, $T_a = 25^\circ C$, unless otherwise specified)

Symbol	Parameter	Conditions	Min.	Typ.	Max.	Unit
V_{IN}	Input Voltage	--	3.6	-	23	V
V_{FB}	Feedback Voltage	$I_{OUT} = 0.1A$	0.784	0.8	0.816	V
I_{FB}	Feedback Bias Current	$I_{OUT} = 0.1A$	-	0.1	0.5	μA
I_{SW}	Switch Current	--	2.5	-	-	A
I_{SSS}	Current Consumption During Power off	$V_{EN} = 0V$	-	10	-	μA
$\frac{\Delta V_{OUT}}{V_{OUT}}$	Line Regulation	$V_{IN} = 5V \sim 23V$	-	1	2	%
$\frac{\Delta V_{OUT}}{V_{OUT}}$	Load Regulation	$I_{OUT} = 0.1$ to 2A	-	0.2	0.5	%
f_{OSC}	Oscillation Frequency	Measure waveform at SW pin	240	300	360	KHz
f_{OSC1}	Frequency of Current Limit or Short Circuit Protect	Measure waveform at SW pin	10	-	-	KHz
V_{SH}	EN Pin Input Voltage	Evaluate oscillation at SW pin	2.0	-	-	V
V_{SL}		Evaluate oscillation stop at SW pin	-	-	0.8	
I_{SH}	EN Pin Input Leakage Current	--	-	20	-	μA
I_{SL}		--	-	-10	-	
I_{OCSET}	OCSET Pin Bias Current	--	75	90	105	μA
T_{SS}	Soft-Start Time	--	0.3	1	2	ms
R_{DSON}	Internal MOSFET Rdson	$V_{IN} = 5V, V_{FB} = 0V$	-	110	150	m Ω
		$V_{IN} = 12V, V_{FB} = 0V$	-	70	100	
EFFI	Efficiency	$V_{IN} = 12V, V_{OUT} = 5V$ $I_{OUT} = 2A$	-	92	-	%
θ_{JA}	Thermal Resistance Junction-to-Ambient		-	65	-	$^\circ C/W$

■ Typical Application Circuit

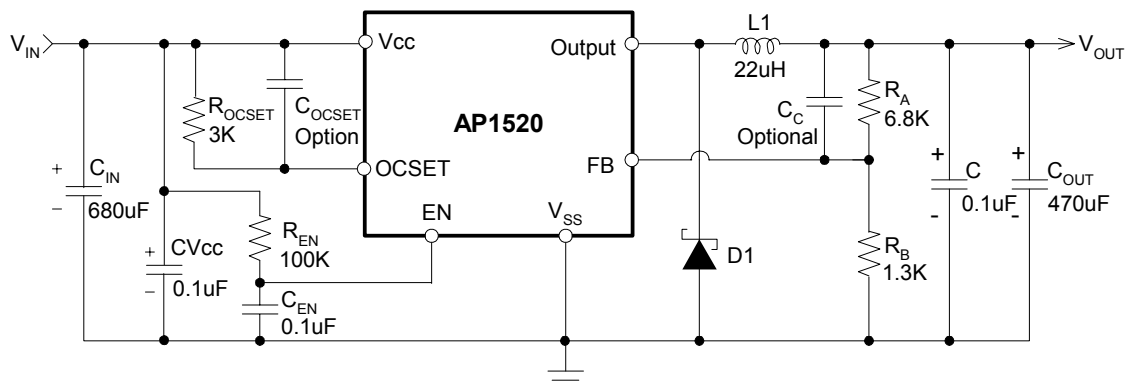

Note: $V_{OUT} = V_{FB} \times (1 + R_A/R_B)$
 $R_B = 0.7K \sim 5K \text{ ohm}$

$V_{IN} = 12V, I_{MAX} = 2A$			
V_{OUT}	2.5V	3.3V	5V
L1 Value	22uH	27uH	33uH

■ Typical Performance Characteristics

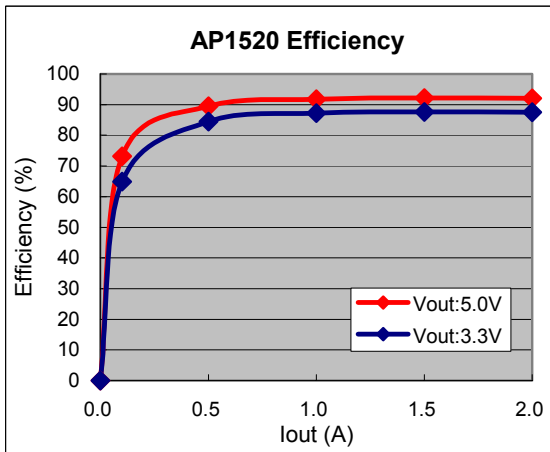
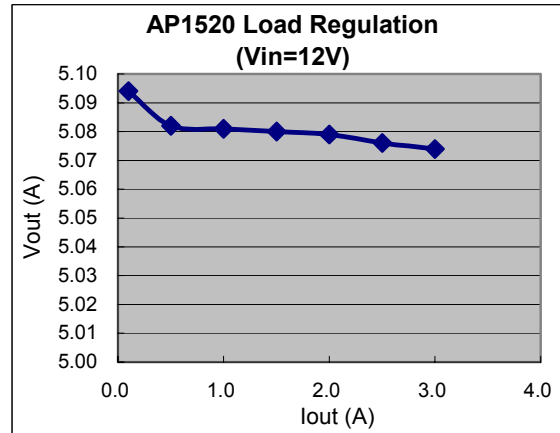
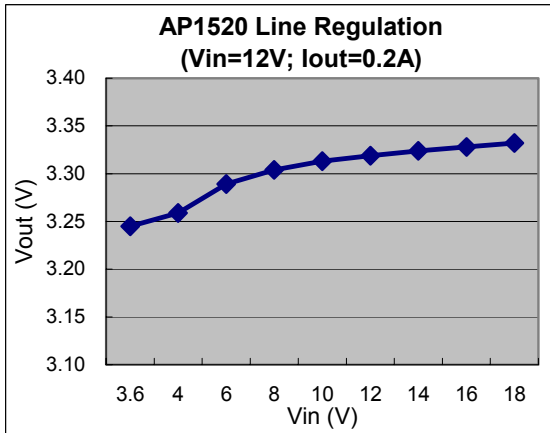
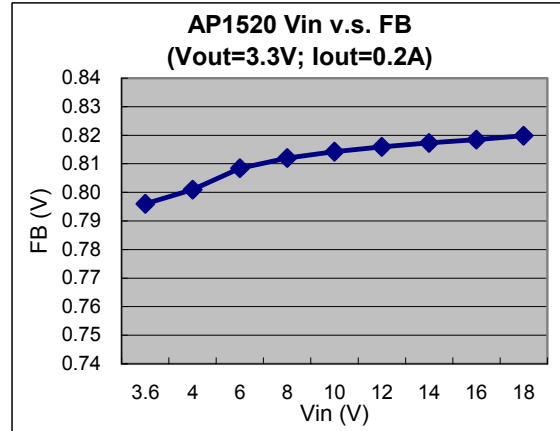
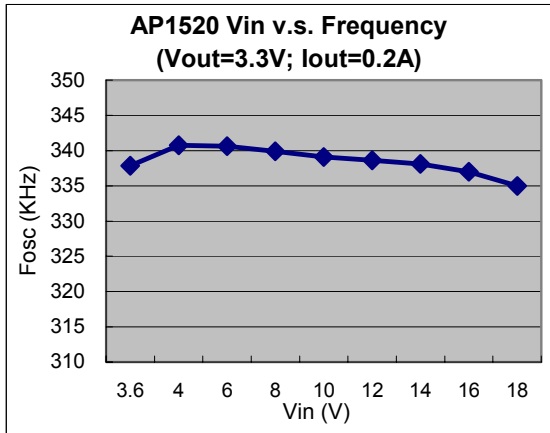

Typical Performance Characteristics (Continued)

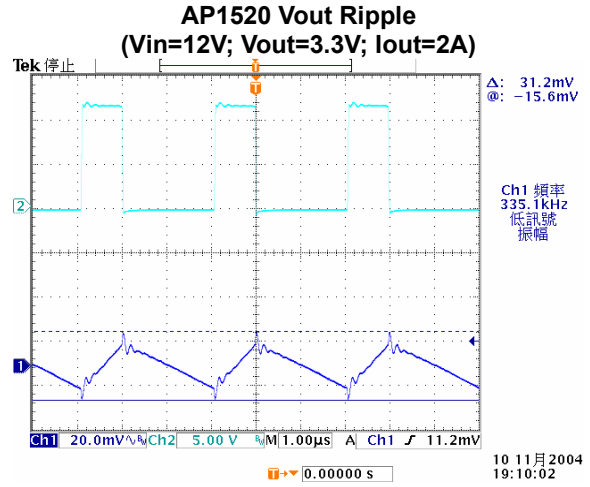
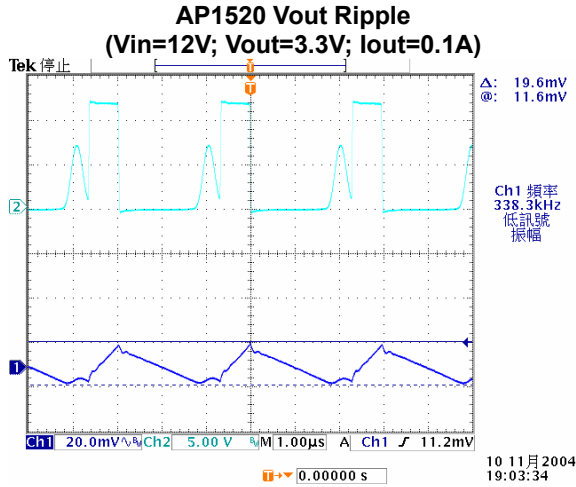

Test Circuit

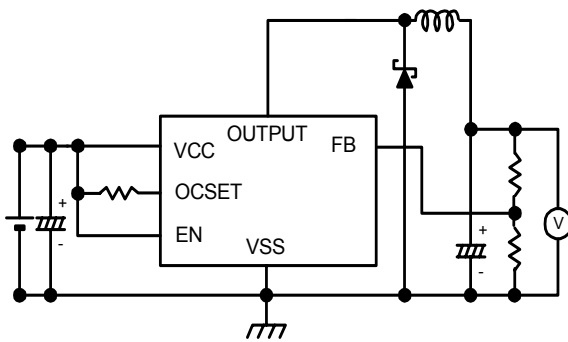
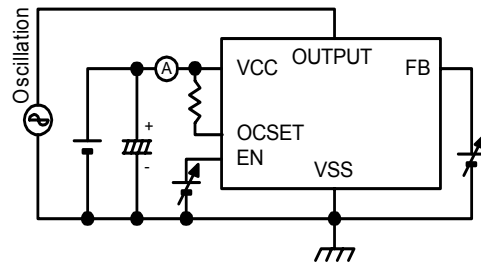
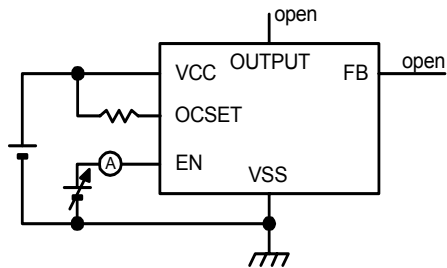

■ Function Description

PWM Control

The AP1520 consists of DC/DC converters that employ a pulse-width modulation (PWM) system. In converters of the AP1520, the pulse width varies in a range from 0 to 100%, according to the load current. The ripple voltage produced by the switching can easily be removed through a filter because the switching frequency remains constant. Therefore, these converters provide a low-ripple power over broad ranges of input voltage and load current.

Under Voltage Lockout

The under voltage lockout circuit of the AP1520 assures that the high-side MOSFET driver outputs remain in the off state whenever the supply voltage drops below 3.3V. Normal operation resumes once V_{CC} rises above 3.5V.

$R_{DS(ON)}$ Current Limiting

The current limit threshold is setting by the external resistor connecting from V_{CC} supply to OCSET. The internal 100uA sink current crossing the resistor sets the voltage at the pin of OCSET. When the PWM voltage is less than the voltage at OCSET, an over-current condition is triggered.

$$I_{LOAD} \times R_{DS(ON)} = I_{OCSET} \times R_{OCSET}$$

See above formula for setting the current limit value.

■ Marking Information

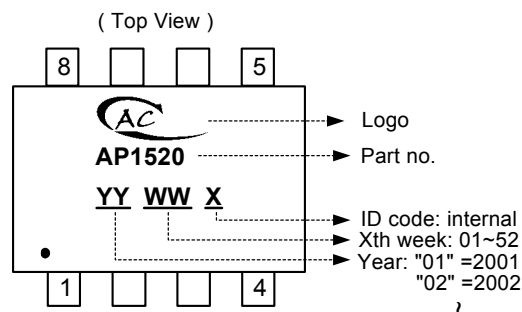

■ Package Information

Package Type: SOP-8L

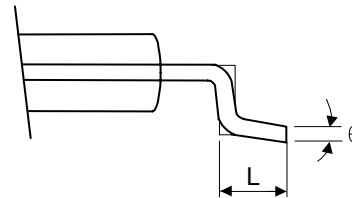
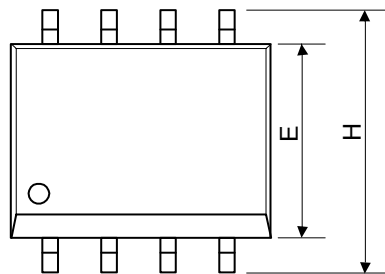

VIEW "A"

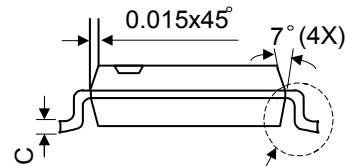
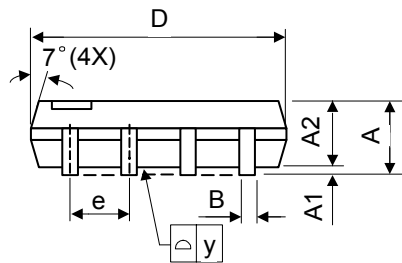

VIEW "A"

Symbol	Dimensions In Millimeters			Dimensions In Inches		
	Min.	Nom.	Max.	Min.	Nom.	Max.
A	1.40	1.60	1.75	0.055	0.063	0.069
A1	0.10	-	0.25	0.040	-	0.100
A2	1.30	1.45	1.50	0.051	0.057	0.059
B	0.33	0.41	0.51	0.013	0.016	0.020
C	0.19	0.20	0.25	0.0075	0.008	0.010
D	4.80	5.05	5.30	0.189	0.199	0.209
E	3.70	3.90	4.10	0.146	0.154	0.161
e	-	1.27	-	-	0.050	-
H	5.79	5.99	6.20	0.228	0.236	0.244
L	0.38	0.71	1.27	0.015	0.028	0.050
y	-	-	0.10	-	-	0.004
θ	0°	-	8°	0°	-	8°