



Rated impedance 30 to 2000  $\Omega$   
Rated current 0,1 to 0,5 A



#### Construction

- Size 0603 to 1210 (EIA) or 1608 to 3225 (IEC)
- Multilayer technology with ferrite

#### Features

- Broadband attenuation
- Suitable for reflow (IR and vapor phase) and wave soldering

#### Applications

Prevention of high-frequency EMI in

- computers, printers
- VCRs, TVs
- cordless phones
- mobile phones

#### Terminals

- Tinned
- Ni intermediate layer

#### Marking

No marking on component

Minimum marking on reel:

Manufacturer, part number, ordering code,  
Z value and tolerance of Z value,  
quantity, date of packing

#### Delivery mode

8-mm blister tape wound on 178-mm  $\varnothing$  reel

For details on taping, packing and packing units [see page 234](#)

**General technical data**

Impedance $ Z $	Measured with HP 4291A at frequency $f_z$
Rated current $I_R$	Maximum dc current at ambient temperature $T_A = 85^\circ\text{C}$
DC resistance $R_{\max}$	Measured at $20^\circ\text{C}$ ambient temperature
Climatic category	In accordance with IEC 60068-1 40/085/56 ( $-40^\circ\text{C}/+85^\circ\text{C}/56$ days damp heat test)
Storage temperature	$-40^\circ\text{C}/+85^\circ\text{C}$
Soldering:	
Wave soldering	Maximum $260^\circ\text{C}$ , 5 s
Infrared soldering	Maximum $250^\circ\text{C}$ , 30 s temperature/time profile $> 215^\circ\text{C}$ , max. 60 s
Vapor-phase soldering	Maximum $(215 \pm 5)^\circ\text{C}$ , max. 60 s
Solderability	$(230 \pm 5)^\circ\text{C}$ , $(4 \pm 1,0)$ s after preheating at $120$ to $150^\circ\text{C}$ , 60 s wetting of soldering area: $\geq 90\%$
Resistance to soldering heat	$(260 \pm 5)^\circ\text{C}$ , $(10 \pm 0,5)$ s after preheating at $120$ to $150^\circ\text{C}$ , 60 s impedance change max. $\pm 75\%$
Permissible PCB bending	2 mm (100 mm long standard PCB)
Temperature cycles	$-40^\circ\text{C}/+85^\circ\text{C}$ , for each 30 min., total 100 cycles impedance change $\leq 20\%$
Humidity test	$40^\circ\text{C}$ , 90 to 95 % r. h. at 200 mA, 1000 h impedance change $\leq 20\%$
Life test	1000 h at $85^\circ\text{C}$ and 200 mA impedance change $\leq 20\%$

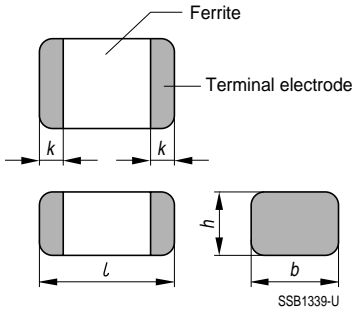
**Dimensional drawing**

Type	Size		Dimensions (mm)			
	EIA	IEC	<i>l</i>	<i>b</i>	<i>h</i>	<i>k</i>
B82482-B	0603	1608	1,6 ± 0,2	0,8 ± 0,15	0,8 ± 0,15	0,4 ± 0,2
B82483-B	0805	2012	2,0 ± 0,2	1,25 ± 0,2	0,9 ± 0,2	0,5 ± 0,3
B82485-B	1206	3216	3,2 ± 0,2	1,6 ± 0,2	1,1 ± 0,2	0,5 ± 0,3
B82486-B	1210	3225	3,2 ± 0,2	2,5 ± 0,2	1,3 ± 0,2	0,5 ± 0,3

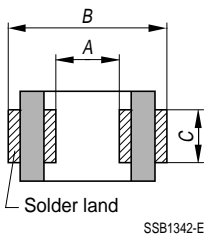
**PCB layout recommendation**

Type	Size		Dimensions (mm)		
	EIA	IEC	<i>A</i>	<i>B</i>	<i>C</i>
B82482-B	0603	1608	0,8	2,4 ... 3,4	0,6
B82483-B	0805	2012	1,2	3,0 ... 4,0	1,0
B82485-B	1206	3216	2,0	4,2 ... 5,2	1,2
B82486-B	1210	3225	2,0	4,2 ... 5,2	1,8

**Characteristics and ordering codes**

 For further technical data [see page 226](#).

Size EIA	IEC	$ Z $ $\Omega$	Toler- ance	$f_z$ MHz	$I_R$ A	$R_{max}$ $\Omega$	Ordering code
0603	1608	30	$\pm 25\%$	100	0,2	0,2	B82482-B1300-A
		60		100	0,2	0,2	B82482-B1600-A
		80		100	0,2	0,3	B82482-B1800-A
		120		100	0,2	0,3	B82482-B1121-A
		300		100	0,1	0,6	B82482-B1301-A
0805	2012	32	$\pm 25\%$	100	0,5	0,2	B82483-B1320-A
		80		100	0,4	0,4	B82483-B1800-A
		120		100	0,2	0,4	B82483-B1121-A
		300		100	0,2	0,9	B82483-B1301-A
		600		100	0,2	1,0	B82483-B1601-A
		1000		100	0,1	1,0	B82483-B1102-A
1206	3216	32	$\pm 25\%$	100	0,5	0,15	B82485-B1320-A
		70		100	0,4	0,3	B82485-B1700-A
		90		100	0,4	0,3	B82485-B1900-A
		150		100	0,2	0,5	B82485-B1151-A
		600		100	0,2	0,5	B82485-B1601-A
		1200		50	0,1	1,0	B82485-B1122-A
1210	3225	90	$\pm 25\%$	100	0,4	0,3	B82486-B1900-A
		2000		30	0,1	1,5	B82486-B1202-A



**Typical electrical characteristics**

Impedance  $|Z|$ , real part R and imaginary part X versus frequency  $f$

—————  $|Z|$  - - - - - R - - - - - X

**Size 0603**

B82482-B1300-A

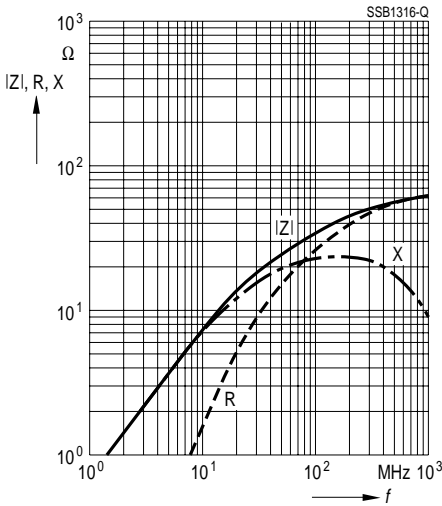

B82482-B1600-A

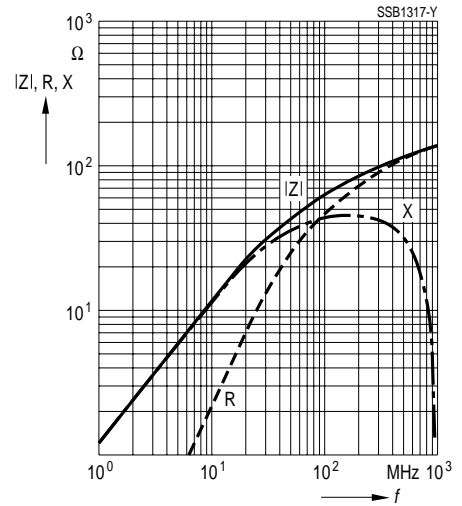

B82482-B1800-A

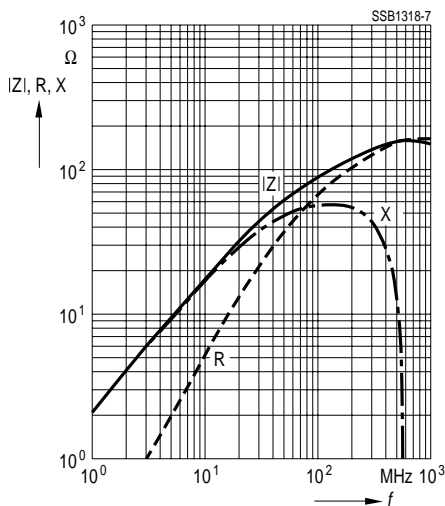

B82482-B1121-A

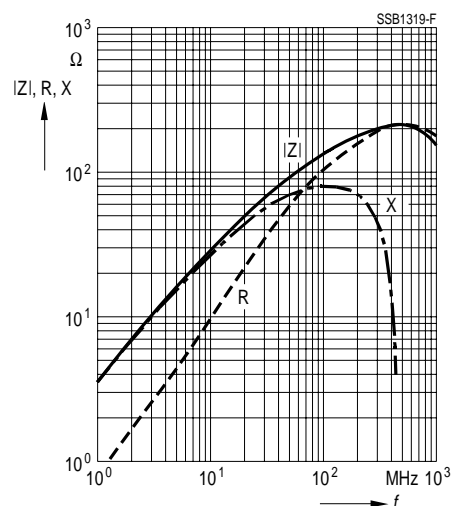



**Typical electrical characteristics**

Impedance  $|Z|$ , real part R and imaginary part X versus frequency  $f$

—————  $|Z|$  - - - - - R - - - - - X

**Size 0603**

B82482-B1301-A

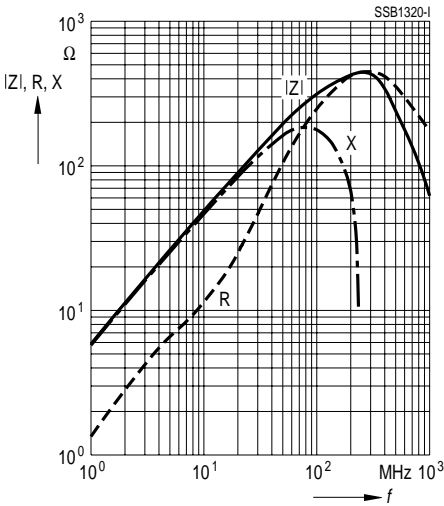

**Size 0805**

B82483-B1320-A

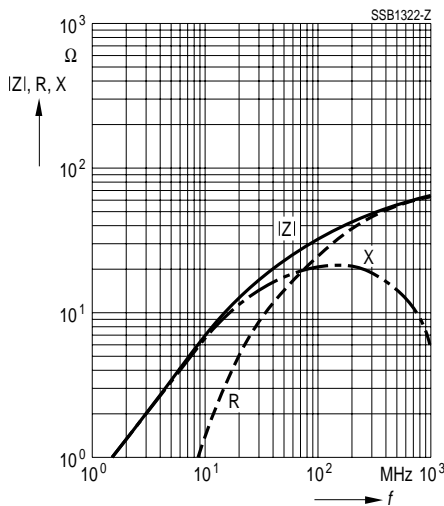

B82483-B1800-A

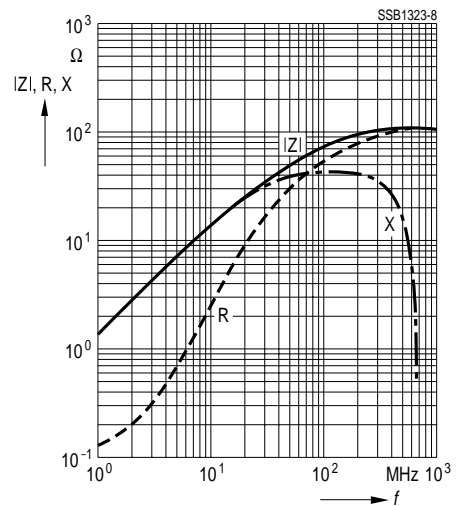



**Typical electrical characteristics**

Impedance  $|Z|$ , real part R and imaginary part X versus frequency  $f$

—————  $|Z|$  - - - - - R - - - - - X

**Size 0805**

B82483-B1121-A

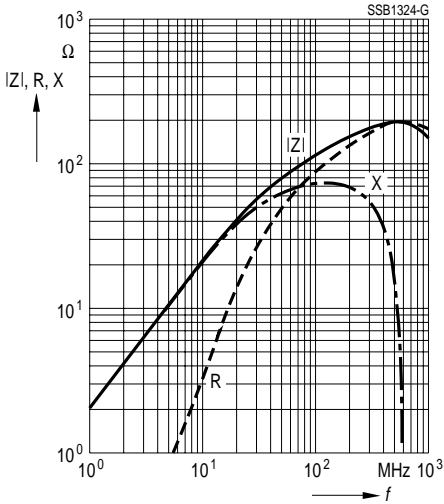

B82483-B1301-A

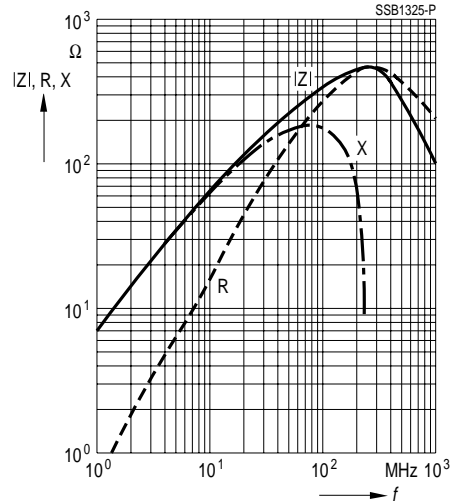

B82483-B1601-A

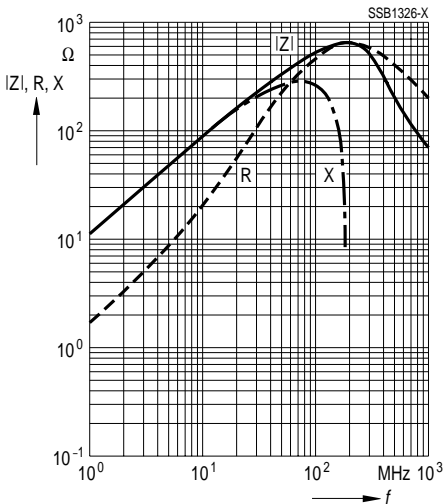

B82483-B1102-A

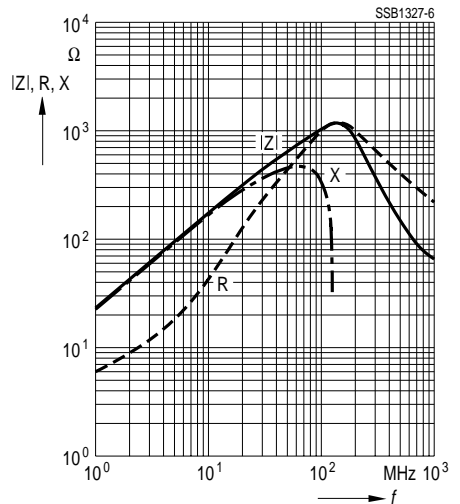



**Typical electrical characteristics**

Impedance  $|Z|$ , real part R and imaginary part X versus frequency  $f$

—————  $|Z|$  - - - - - R - - - - - X

**Size 1206**

B82485-B1320-A

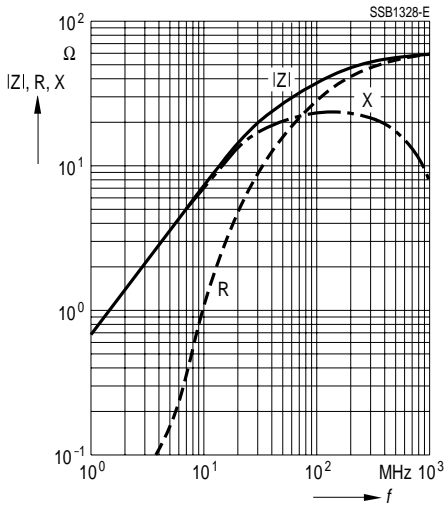

B82485-B1700-A

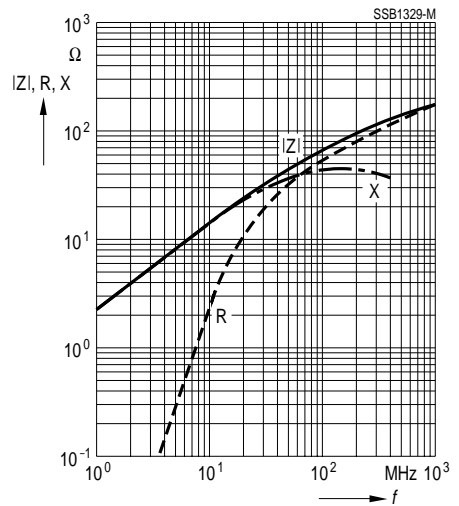

B82485-B1900-A

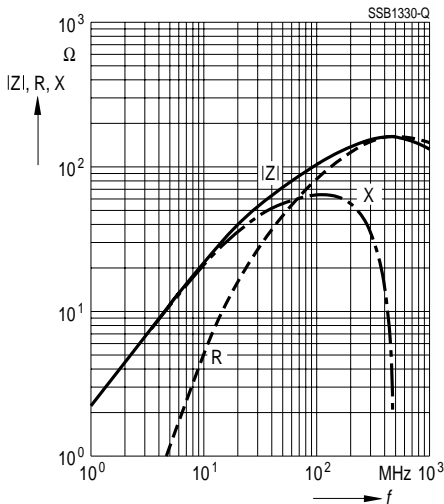

B82485-B1151-A

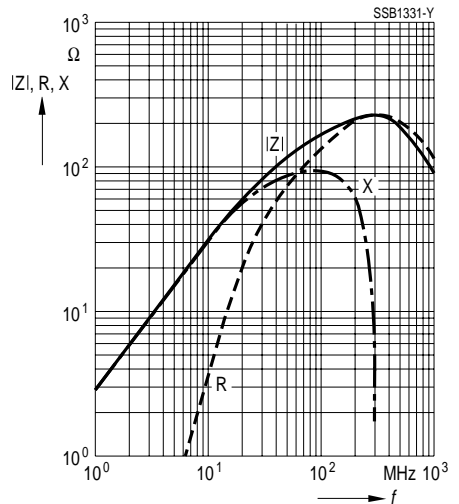





**Typical electrical characteristics**

Impedance  $|Z|$ , real part R and imaginary part X versus frequency  $f$

—————  $|Z|$  - - - - - R - - - - - X

**Size 1206**

B82485-B1601-A

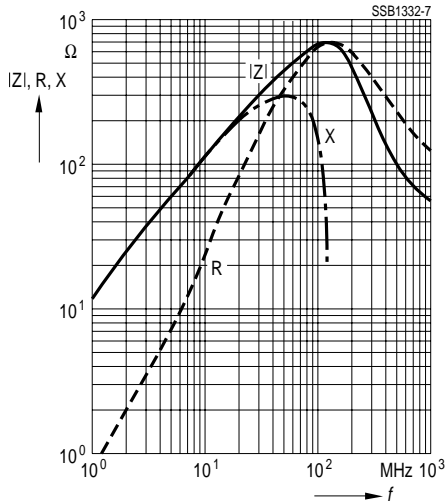

B82485-B1122-A

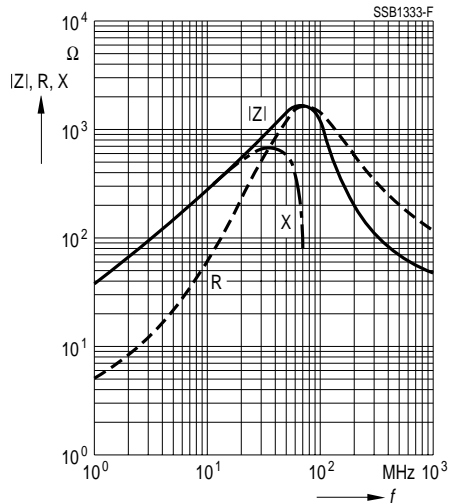

**Size 1210**

B82486-B1900-A

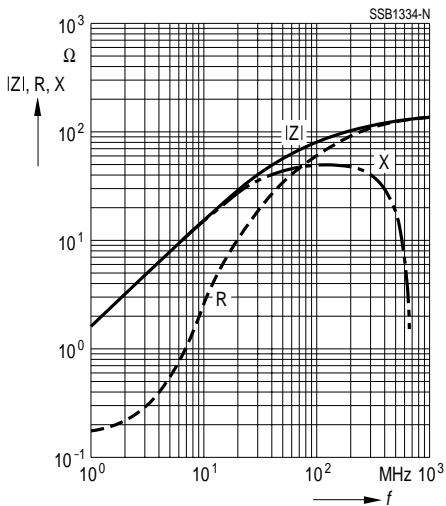

B82486-B1202-A

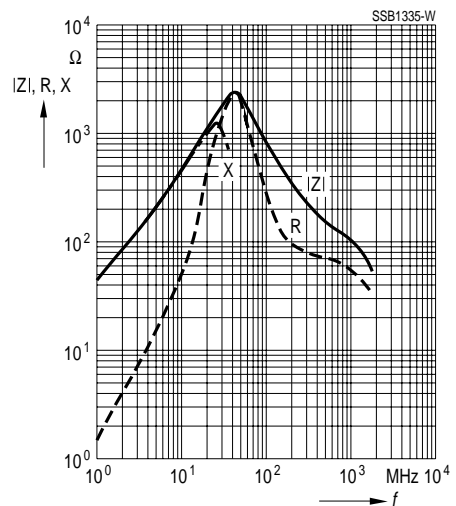



### 8-mm blister tape

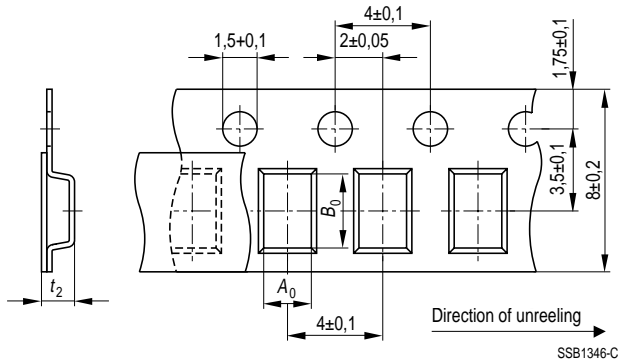

SSB1346-C

Type	Size		Dimensions (mm)		
	EIA	IEC	$A_0$	$B_0$	$t_2$ (max.)
B82482-B	0603	1608	$1,14 \pm 0,1$	$1,75 \pm 0,1$	1,3
B82483-B	0805	2012	$1,54 \pm 0,1$	$2,32 \pm 0,1$	1,3
B82485-B	1206	3216	$1,94 \pm 0,1$	$3,54 \pm 0,1$	1,6
B82486-B	1210	3225	$2,80 \pm 0,2$	$3,54 \pm 0,2$	1,9

### Reel packing

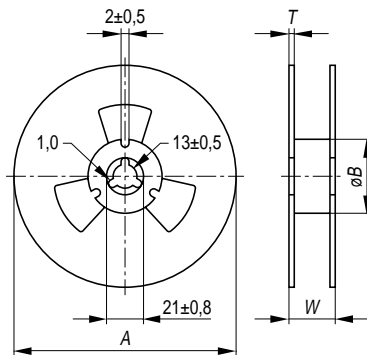

SSB1343-M

Type	Size		Dimensions (mm)				Packing unit Pieces/reel
	EIA	IEC	$A$	$\varnothing B$	$W$	$T$	
B82482-B	0603	1608	$178 \pm 2$	$60 \pm 1$	$11 \pm 1$	$1,2 \pm 0,5$	4000
B82483-B	0805	2012					4000
B82485-B	1206	3216					3000
B82486-B	1210	3225					2500