

SONY**CXA1073M/Q****Read/Write Amplifier for Floppy Disk Drive****Description**

CXA1073M/Q are IC's for FDD (Floppy Disk Drive) usage. Functions such as Read, Write, Erase and supply voltage detection circuits are contained in 1 chip.

Features

- Single power supply 5V
- Dual power supply 5V, 12V
- Peak shift at the Read circuit is less than 1% of the input voltage range from 0.25 mVp-p to 10 mVp-p.
- A low preamplifier input equivalent noise voltage of $3.3 \text{ nV}/\sqrt{\text{Hz}}$ (Typ.) keeps read data output jitter to a minimum.
- Built-in pulse width switching function at the first monostable multivibrator of the time domain filter enables selection from 300 to 360 rpm.
- Built-in write current switching function enables selection of write current on both inner and outer tracks.
- Built-in 5V and 12V supply voltage detection circuits inhibit illegal writing during power supply voltage fluctuations.
- Compatible with battery driver FDD as power consumption is low 100 mW (Typ.) when operated with 5V single-source.
- Built-in time constant capacitors at the first and second monostable multivibrators, improved circuitry of the Read signal system contribute to a sizeable reduction of external components.

Function

Read, Write and Erase, Supply ON/OFF detection for FDD.

Structure

Bipolar silicon monolithic IC

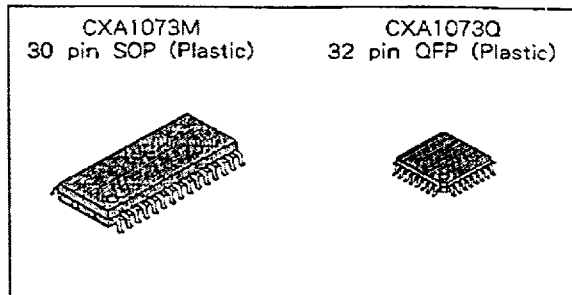

Absolute Maximum Ratings (Ta = 25°C)

• Supply voltage	Vcc1	7	V	
• Supply voltage	Vcc2	17	V	
• Digital signal input pin*		-0.5 to +5.5	V	
• Power ON output voltage applied	Vcc1	0.3	V	
• Erase output voltage applied	Vcc2	0.3	V	
• Head 0A, 0B, 1A, 1B voltage applied		22	V	
• Power ON output SINK current		20	mA	
• Erase output SINK current		150	mA	
• Operation temperature	Topr	-20 to +75	°C	
• Storage temperature	Tstg	-55 to +150	°C	
• Allowable power dissipation	Pd	550	mW	(CXA1073M)
		500	mW	(CXA1073Q)

Note) Indicates WRITE CURRENT, WRITE DATA, WRITE GATE, SIDE1 and MMVA CONTROL pins.

*Input voltage

Recommended Operating Conditions

• Single supply operation 5V	Vcc1 = Vcc2	4.4 to 6.0	V
• Dual supply operation 5V, 12V	Vcc1	4.4 to 6.0	V
	Vcc2	10.8 to 13.2	V

Block Diagram and Pin Configuration
CXA1073M

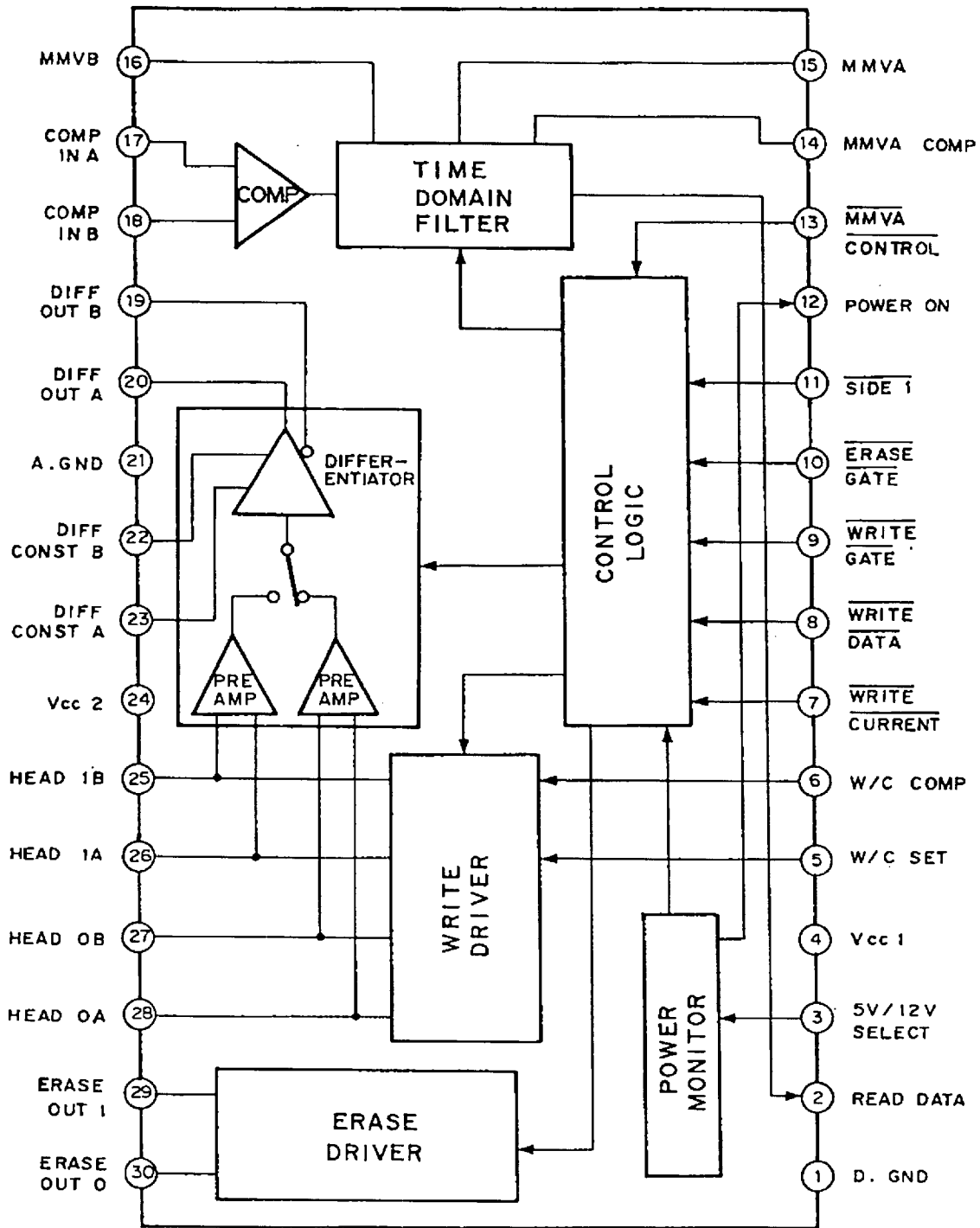

Block Diagram and Pin Configuration
CXA1073Q

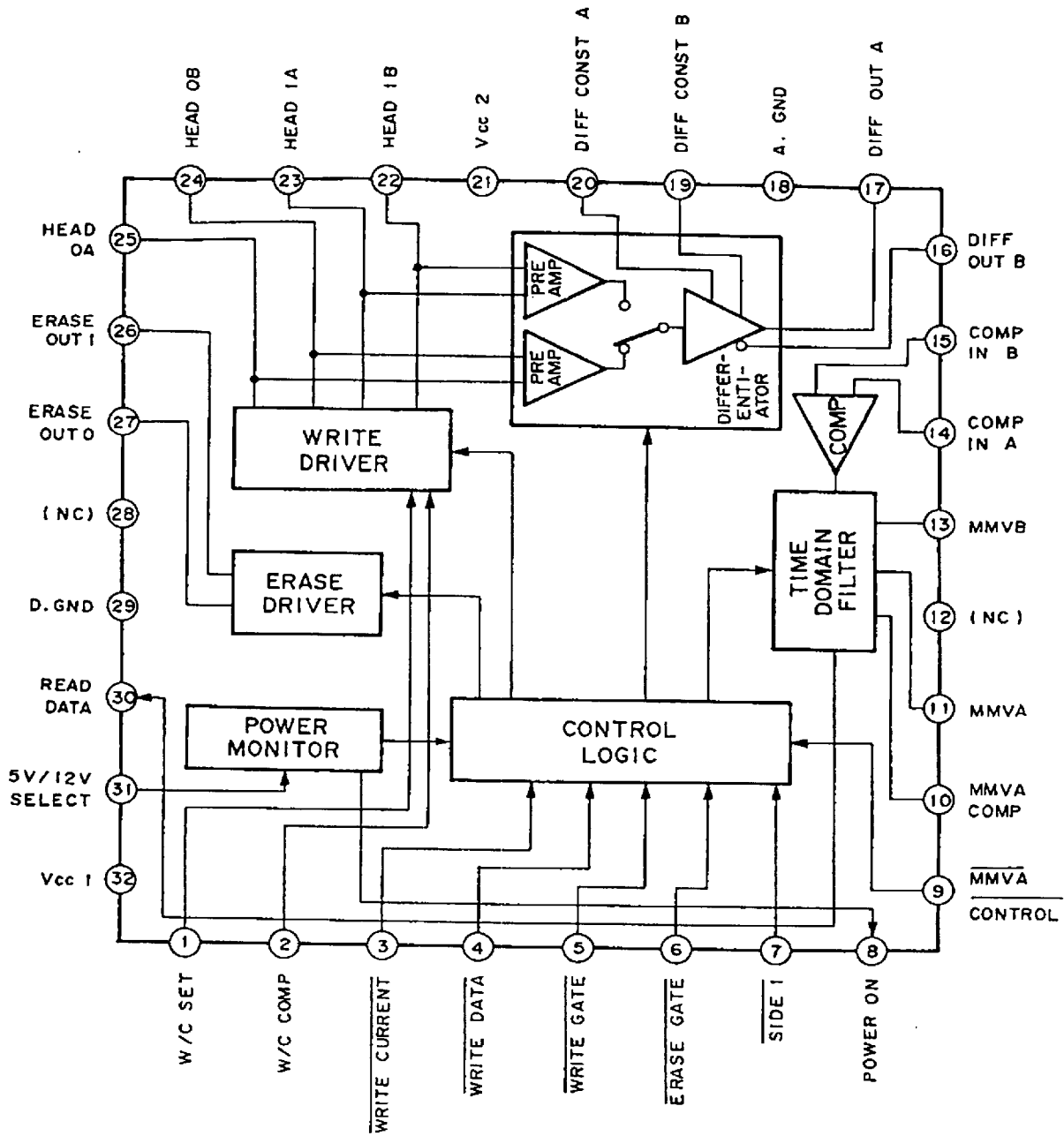

Pin Description and Equivalent Circuit
CXA1073M

Note) Pin numbers in brackets are for CXA1073Q.

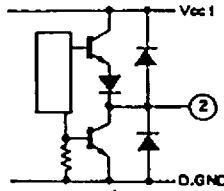
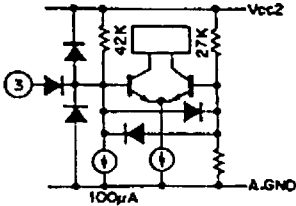
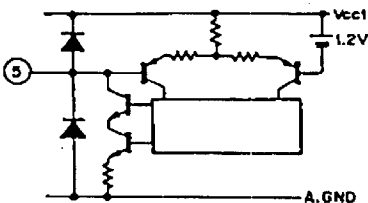
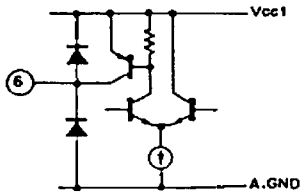
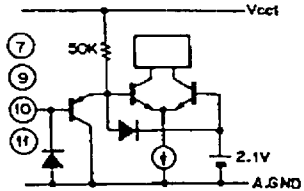
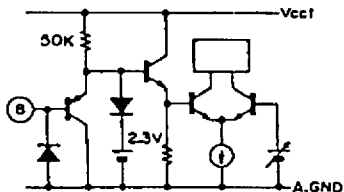
No.	Symbol	Equivalent circuit	Description
1 (29)	D.GND		GND connecting pin of digital system
2 (30)	READ DATA		Read data output pin.
3 (31)	5V/12V SELECT		5V/12V Power selection pin. When 5V single source in use connect to power supply. When 5V/12V commonly in use connect to GND.
4 (32)	Vcc1		Connecting pin to 5V power supply system.
5 (1)	W/C SET		Resistance connecting pin for write current setting. Connect R _w resistance for write current setting between this pin and pin 4 (Vcc1), then set write current value.
6 (2)	W/C COMP		Resistance connecting pin for write current compensation. Connect R _{wc} resistance for write current compensation between this pin and pin 5, then set write current increase volume.
7 (3)	WRITE CURRENT		Write current control pin. Write current increases at logic voltage "L".
9 (5)	WRITE GATE		Write gate signal input pin. Write system is activated at logic voltage "L".
10 (6)	ERASE GATE		Erase gate signal input pin. Erase system is activated at logic voltage "L".
11 (7)	SIDE 1		HEAD, SIDE switching signal input pin. HEAD 1 system is activated at logic voltage "L". While HEAD 0 system is activated at logic voltage "H".
8 (4)	WRITE DATA		Write data input pin. A digital input of the schmitt type, it is triggered when logic voltage shifts from "H" to "L".

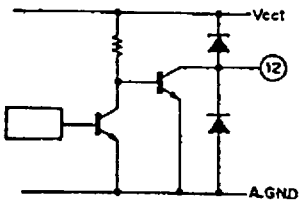
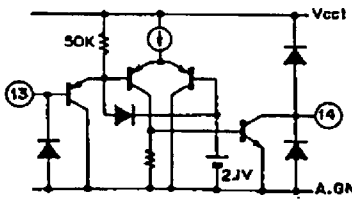
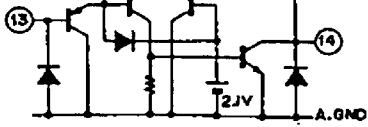
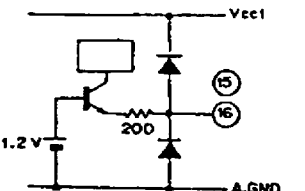
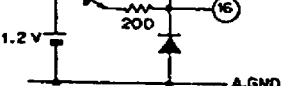
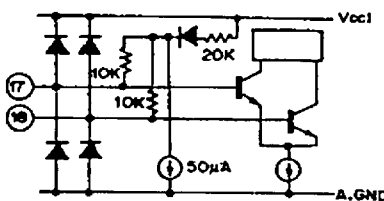
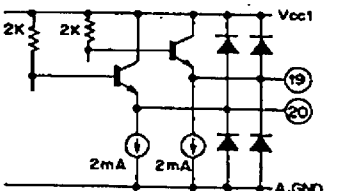
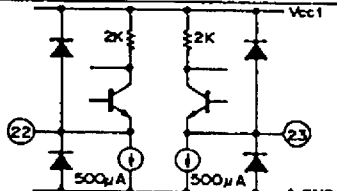
No.	Symbol	Equivalent circuit	Description
12 (8)	POWER ON		Voltage decrease detection output pin. An open collector pin that outputs "L" under the following conditions. 1. When 5V single power supply is used and Vcc1 is below normal value. 2. When 5V/12V dual power supply is used and Vcc1 or Vcc2 is below normal value.
13 (9)	MMVA CONTROL		Time domain filter time constant control pin. The first monostable multivibrator pulse width gets shorter at the logic voltage "L".
14 (10)	MMVA COMP		Resistance connecting pin for time domain filter time constant compensation. Connect RA comp resistance for the 1st monostable multivibrator time constant compensation between this pin and pin 15.
15 (11)	MMVA		Time domain filter 1st monostable multivibrator pulse width setting pin. Connect 1st monostable multivibrator pulse width setting resistance RA between this pin and A. GND.
16 (13)	MMVB		Time domain filter 2nd monostable multivibrator pulse width setting pin. Connect 2nd monostable multivibrator pulse width setting resistance RB between this pin and A. GND.
17 (14)	COMP IN A		Comparator differential input pin.
18 (15)	COMP IN B		
19 (16)	DIFF OUT B		Differentiator differential output pin.
20 (17)	DIFF OUT A		
21 (18)	A. GND		Ground connecting pin for analog system.
22 (19)	DIFF CONST B		Differentiator constant connecting pin. Connect the differentiator constant between these 2 pins. This also serves as the preamplifier output waveform observation point.
23 (20)	DIFF CONST A		
24 (21)	Vcc2		Supply connection pin for 5V system (when 5V single source supply is in use) or, 12V system (when 5V/12V dual source supply is in use). When the 5V single source supply is in use, connect this pin with pin 4 (Vcc).

No.	Symbol	Equivalent circuit	Description
25 (22)	HEAD 1B		Magnetic head I/O pin. Connects magnetic heads for both Rec/PB. When pin 17 SIDE 1 logic voltage is at "L", head 1 system is activated and when logic voltage is at "H", head 0 system is activated.
26 (23)	HEAD 1A		
27 (24)	HEAD 0B		
28 (25)	HEAD 0A		
29 (26)	ERASE OUT 1		Erase current output pin for Head 1 system.
30 (27)	ERASE OUT 0		Erase current output pin for Head 0 system.

Electrical Characteristics

Consumption current

Ta = 25°C, Vcc1 = 5V, Vcc2 = 5/12V

Item	Symbol	Condition	Test Circuit	Test Point	Min.	Typ.	Max.	Unit
For 5V single source Consumption current for Read	ICCR	Vcc1 = Vcc2 = 5V	—	—	12.0	19.0	27.0	mA
For 5V single source Consumption current for Write, Erase	ICCWE	Vcc1 = Vcc2 = 5V Rw = 4.3kΩ	—	—	17.0	23.5	33.0	mA
For 5V, 12V dual supply usage Consumption current for Read 5V	ICC1R	Vcc1 = 5V, Vcc2 = 12V	—	—	10.0	16.5	24.5	mA
For 5V, 12V dual supply usage Consumption current	ICC2R	Vcc1 = 5V, Vcc2 = 12V	—	—	1.2	2.4	4.0	mA
For 5V, 12V dual supply usage Consumption current for WRITE/ERASE 5V consumption current	ICC1WE	Vcc1 = 5V, Vcc2 = 12V Rw = 4.3kΩ	—	—	13.0	20.5	30.5	mA
For 5V, 12V dual supply usage Consumption current for WRITE/ERASE 12V consumption current	ICC2WE	Vcc1 = 5V, Vcc2 = 12V Rw = 4.3kΩ	—	—	3.0	3.5	4.5	mA

Supply observation system

Ta = 25°C

Item	Symbol	Condition	Test circuit	Test point	Min.	Typ.	Max.	Unit
For 5V single supply Supply ON/OFF detector Threshold voltage	VTH	Vcc1 = Vcc2	—	—	3.5	3.9	4.3	V
For 5V, 12V dual supply usage Supply ON/OFF detector 5V threshold voltage	VTH5	Vcc2 = 12V	—	—	3.5	3.9	4.3	V
For 5V, 12V dual supply usage Supply ON/OFF detector 12V threshold voltage	VTH12	Vcc1 = 5V	—	—	8.0	8.8	9.8	V

Read

Ta = 25°C, VCC1 = 5V, VCC2 = 5/12V

Item	Symbol	Condition	Test circuit	Test point	Min.	Typ.	Max.	Unit
Preamplifier voltage gain SIDE 0	GV0	Vi = 3mVp-p f = 100kHz	1	FG	30	35.5	41	V/V
Preamplifier voltage gain SIDE 1	GV1	Vi = 3mVp-p f = 100kHz, SW1, 5 = b						
Preamplifier frequency characteristics SIDE 0	BW0	Av / Avo = -3dB Vi = 1mVp-p	1	FG	5			MHz
Preamplifier frequency characteristics SIDE 1	BW1	Av / Av1 = -3dB Vi = 1mVp-p, SW1, 5 = b						
Preamplifier input equivalent noise voltage SIDE 0	EN0	Vi = 0 Bandwidth = 400Hz to 1MHz	1	FG		3.3	4.5	μVrms
Preamplifier input equivalent noise voltage SIDE 1	EN1	Vi = 0 Bandwidth = 400Hz to 1MHz SW1, 5 = b						
Differentiator differential output Offset voltage	VOFSD	Vi = 0	1	DE	-50		+50	mV
Differentiator differential output Voltage amplitude	VOD	f = 100kHz, Vi = 50mVp-p SW4 = ON	1	DE	3.6	4.0		Vp-p
Time domain filter 1st monostable multivibrator pulse width accuracy	ETM1	Fig. 1. RA = 43kΩ Vi = 3mVp-p, f = 100kHz SW3, 4 = ON	1	BC A	-10		+10	%
Time domain filter Second monostable mul- tivibrator pulse width ac- curacy	ETM2	Fig. 1. RB = 5.1kΩ Vi = 3mVp-p, f = 100kHz SW3, 4 = ON	1	A	-15		+15	%
Time domain filter 1st monostable multivibrator pulse width compensation accuracy	ETMIC	Fig. 1. RA = 43kΩ RAc = 51kΩ Vi = 3mVp-p, f = 100kHz SW2, 3, 4 = b	1	A	-15		+15	%
Read data output "L" output voltage	VOH	IOL = 2mA	1	A			0.5	V
Read data output "H" output voltage	VOL	Ioh = -0.4mA	1	A	2.8			V
Read data output Rise time	TR	RL = 2kΩ CL = 20pF	1	A			100	ns
Read data output Fall time	TF	RL = 2kΩ CL = 20pF	1	A			100	ns
Peak shift	PS	Fig. 1. Vi = 0.25mVp-p to 10mVp-p f = 62.5kHz SW3, 4 = ON	1	A			1	%

First and Second Monostable Multivibrator Pulse Width Accuracy and Peak Shift Test Conditions.

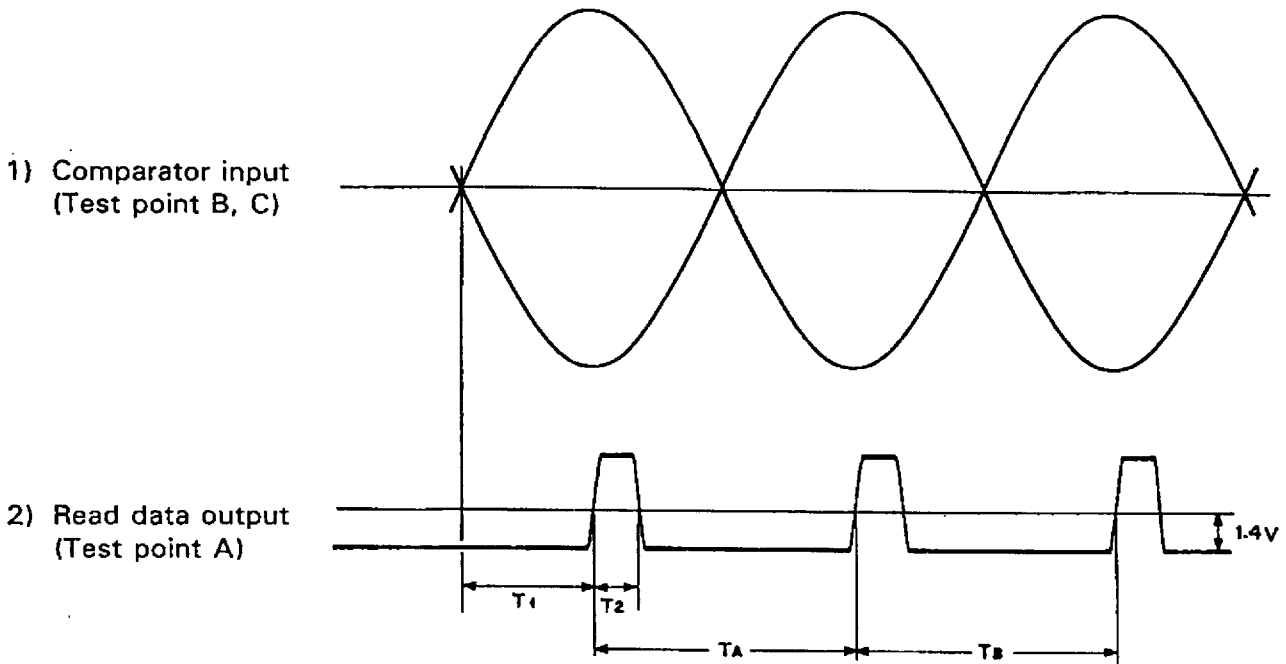

Fig. 1

- First monostable multivibrator pulse width accuracy.

$$ETM1 = \left(\frac{T_1}{2.8\mu s} - 1 \right) \times 100 (\%)$$

- Second monostable multivibrator pulse width accuracy.

$$ETM2 = \left(\frac{T_2}{500ns} - 1 \right) \times 100 (\%)$$

- First monostable multivibrator pulse width compensation accuracy.

$$ETM1C = \left(\frac{T_1 - T_1'}{1.2\mu s} - 1 \right) \times 100 (\%)$$

That is, when; T_1 : $\overline{MMVA CONTROL} = "H"$
 T_1' : $\overline{MMVA CONTROL} = "L"$

- Peak shift

$$PS = \frac{1}{2} \left| \frac{T_A - T_B}{T_A + T_B} \right| \times 100 (\%)$$

WRITE·ERASE

Ta = 25°C, Vcc1 = 5V, Vcc2 = 5/12V

Item	Symbol	Condition	Test circuit	Test point	Min.	Typ.	Max.	Unit
Write current output accuracy Note 1	EW	$\overline{WG} = "L"$ $R_w = 4.3k\Omega$	2	GHIJ	- 7		+ 7	%
Write current output unbalance	DW	$\overline{WG} = "L"$	2	GHIJ	- 1		+ 1	%
Write current compensation current accuracy Note 2	EWC	$\overline{WG} = "L"$ $R_w = 4.3k\Omega$ $R_{wc} = 11k\Omega$	2	GHIJ	- 10		+ 10	%
Head I/O pin Leak current during write	ILKW	$\overline{WG} = "L"$	2	GHIJ			10	μA
Head I/O pin Saturation voltage during write	VSW	$\overline{WG} = "L"$ $SW1 = b$	2	G'H'I'J'			1	V
Erase current switch Leak current	ILKE	$\overline{EG} = "L"$	2	KL			10	μA
Erase current switch Output saturation voltage	VSE	$\overline{EG} = "L"$ $I = 100mA$ $SW2 = b$	2	K'L'			500	mV

Note) 1. Write current output accuracy.

$$E_w = \left(\frac{I_w}{2.88mA} - 1 \right) \times 100 (\%)$$

2. Write current compensation current accuracy.

$$E_{wc} = \left(\frac{I_w' - I_w}{1.04mA} - 1 \right) \times 100 (\%)$$

I_w; WRITE CURRENT = "H", I_w'; WRITE CURRENT = "L"

Logic input section

Ta = 25°C, Vcc1 = 5V, Vcc2 = 5/12V

Item	Symbol	Condition	Test circuit	Test point	Min.	Typ.	Max.	Unit
Digital signal input "L" input voltage	VLD		2	ACDEF			0.8	V
Digital signal input "H" input voltage	VHD		2	ACDEF	2.0			V
Shmitt type Digital signal input "L" input voltage	VLSD		2	B			0.8	V
Shmitt type Digital input "H" input voltage	VHSD		2	B	2.0			V
Digital signal input "L" input current	ILD	V _L = 0V	2	ABCDEF	- 20			μA
Digital signal input "H" input current	IHD	V _H = 5V	2	ABCDEF			10	μA

Electrical Characteristics Test Circuit 1

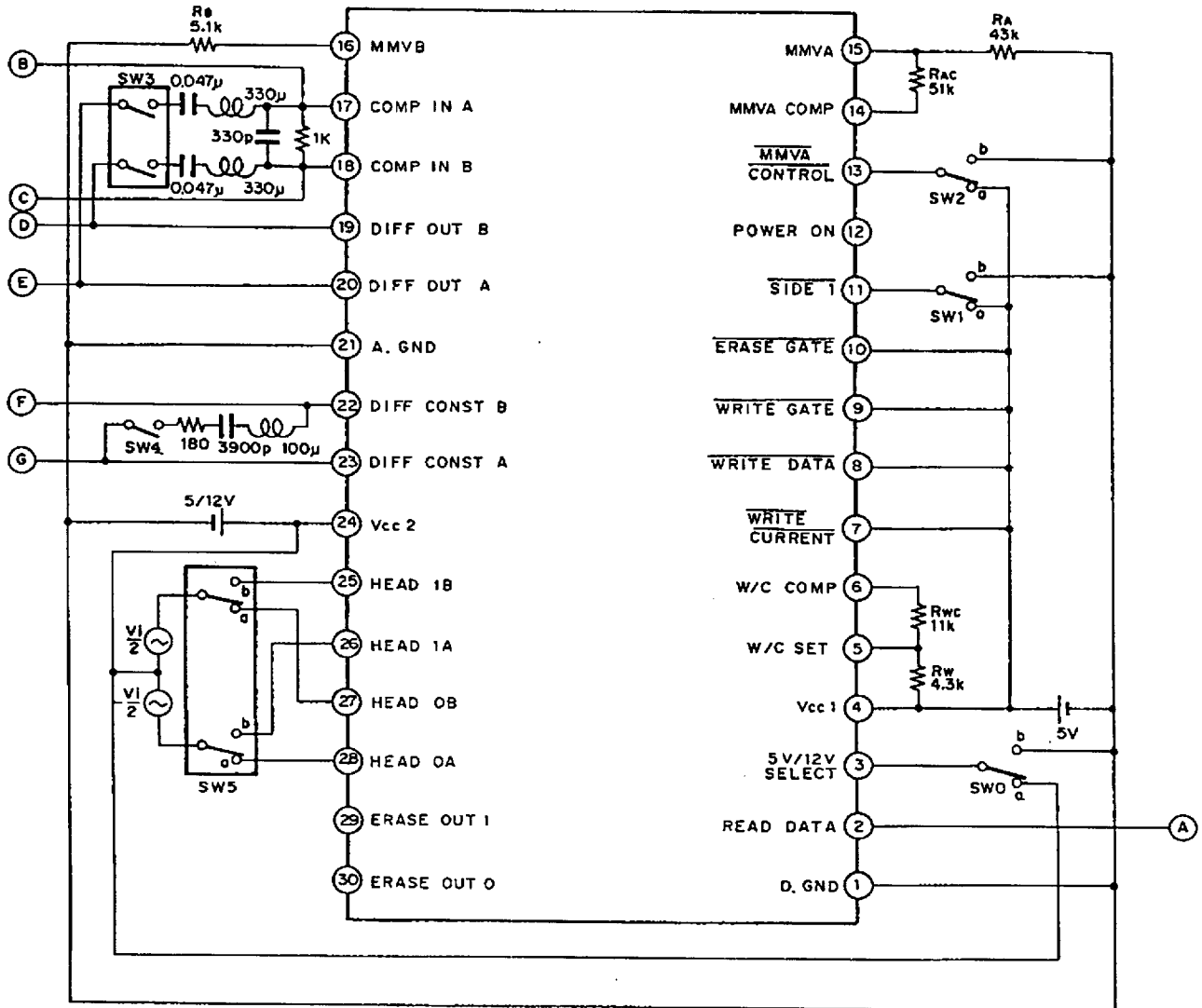

Note) 1. The IC's pin numbers are those of CXA1073M.

2. SW is on 'a' side unless otherwise specified. However for SW0, when Vcc2 = 5V 'a' side, and when Vcc2 = 12V, 'b' side is taken.

Electrical Characteristics Test Circuit 2

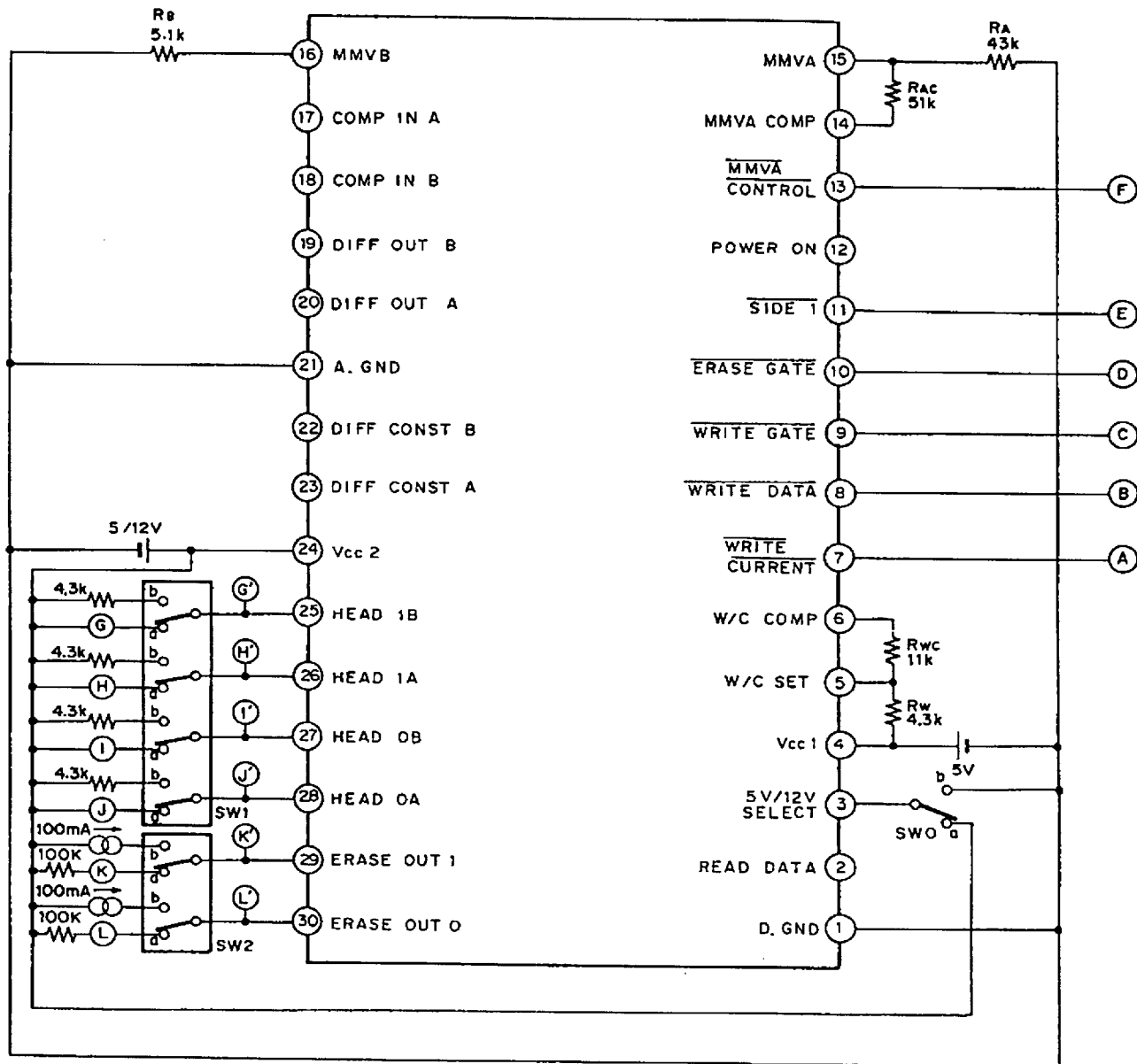

- Note) 1. The IC's pin numbers are those of CXA1073M.
 2. SW is on 'a' side unless otherwise specified. However for SW0, when Vcc2 = 5V 'a' side, and when Vcc2 = 12V, 'b' side is taken.

Description of Function

1) READ

PRE AMP

Amplify the input signal.

Differentiator

The signal amplified at the Preamplifier is differentiated by means of an external capacitor.

Comparator

The differentiator differential output crosspoint is detected.

Time domain filter

The comparator output is converted into READ DATA using 2 monostable multivibrators.

With the first one unnecessary pulse are eliminated. With the second the Read data width is determined.

The first monostable multivibrator pulse width T_A is set through the resistor R_A located between pin 15 and A.GND.

$$T_A = 60R_A + 230 \text{ (ns)} \quad R_A \text{ (k}\Omega\text{)}$$

The second monostable multivibrator pulse width T_B is set through the resistor R_B located between pin 16 and A.GND.

$$T_B = 86 R_B + 60 \text{ (ns)} \quad R_B \text{ (k}\Omega\text{)}$$

2) WRITE

Write data input from pin 8 is frequency demultiplied by means of the T flip flop to make up the head recording current.

Set write current I_w by means of the resistor R_w located between pin 5 and V_{cc1} .

$$I_w = 11.5/R_w + 0.20 \text{ (mA)} \quad R_w \text{ (k}\Omega\text{)}$$

Set write current compensation I_{WC} by means of the resistor R_{WC} located between pins 6 and 5.

$$I_{WC} = 11.2/R_{WC} \text{ (mA)} \quad R_{WC} \text{ (k}\Omega\text{)}$$

3) ERASE

Pins 29 and 30 feature open collector output. Erase current is set through the resistor located between the above pins and the eraser head.

4) Supply ON/OFF Detector

The reduced voltage of the supply voltage is detected, Write and Erase operations are stopped as given in the below procedures and both Record and Erasure functions are prohibited.

1) For 5V single source

$$V_{CC1} = V_{CC2} \text{ below the specified value}$$

2) For 5V, 12V dual supply

Both V_{CC1} and V_{CC2} , or either below the specified value.

Note) Pin numbers are those of CXA1073M. For CXA1073Q refer to the pin configuration.

Application Circuit

1. 5V single source supply (at 300 rpm)

Note) Pin numbers are those of CXA1073M.
For CXA1073Q refer to the pin configuration.

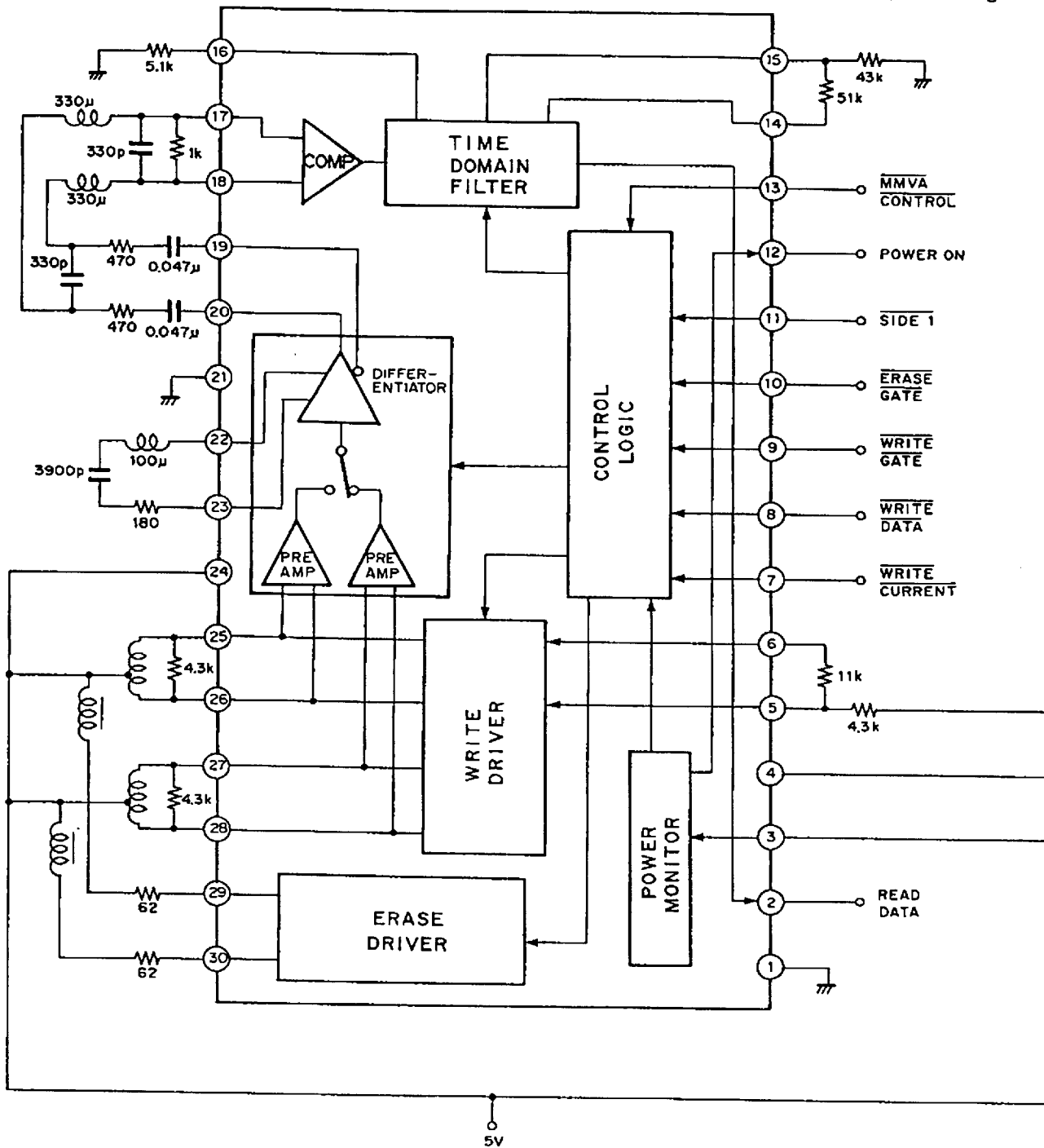

2. 5V, 12V Dual Supply (at 300 rpm)

Note) Pin numbers are those of CXA1073M.
For CXA1073Q refer to the pin configuration.

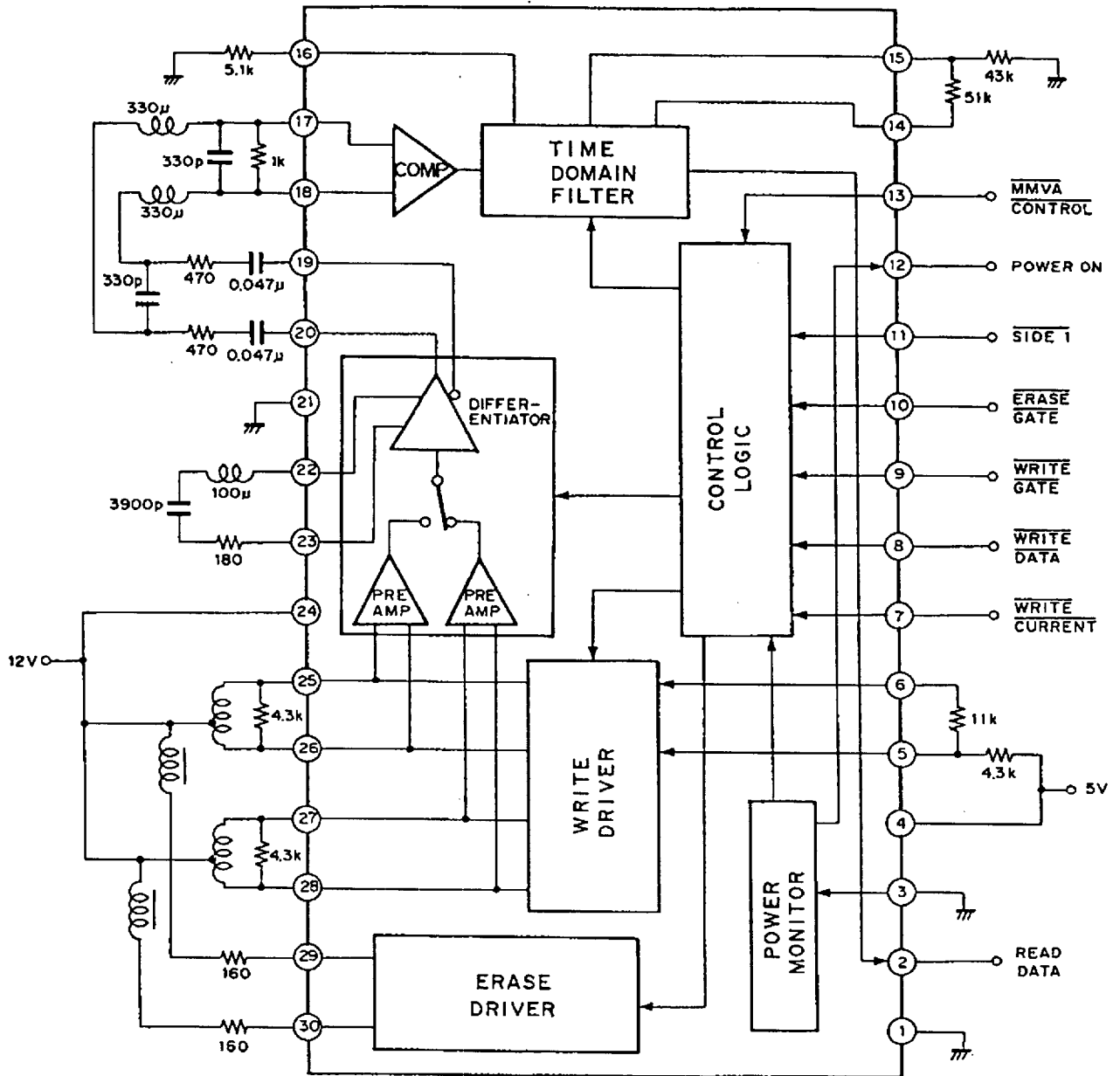

Note) Pin numbers are those of CXA1073M.
For CXA1073Q refer to the pin configuration.

Phase and normalized pre-amp. voltage gain vs. Frequency

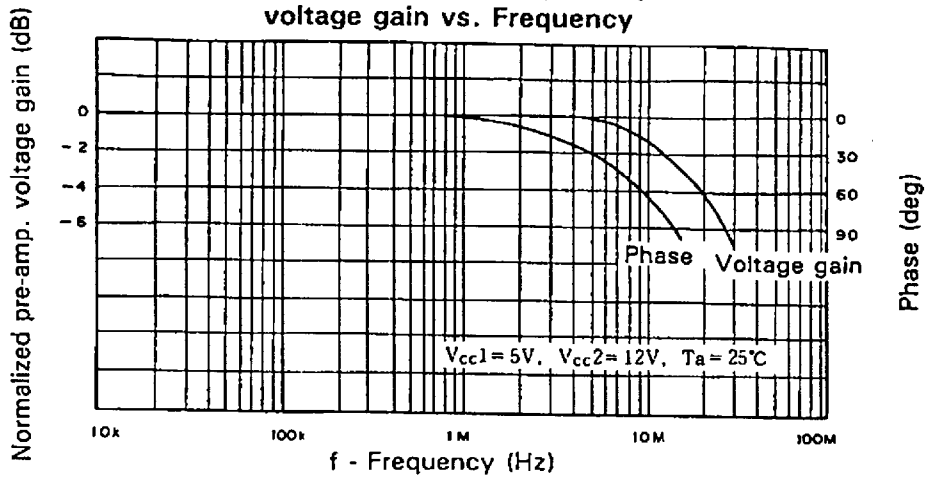

Normalized pre-amp. + differentiator voltage gain vs. Ambient temperature

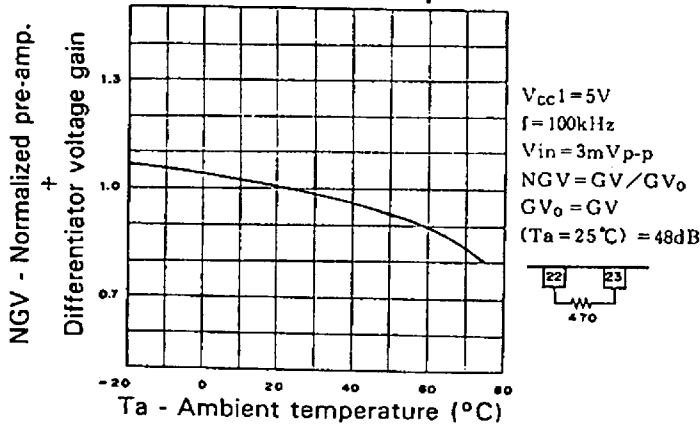

Normalized pre-amp. + differentiator voltage gain vs. Supply voltage

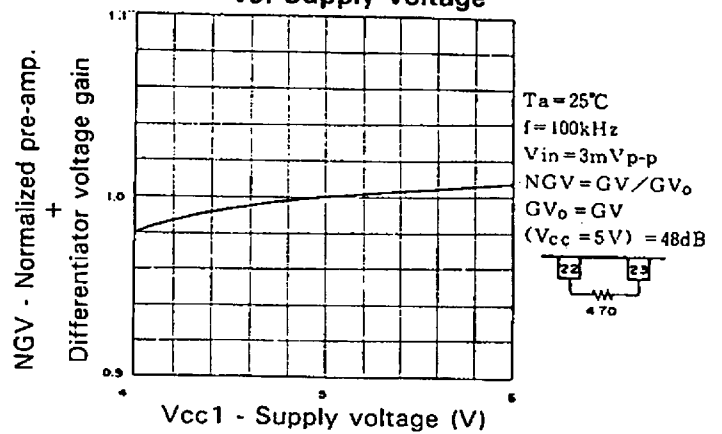

Normalized first monostable multivibrator pulse width NTA vs. Ambient temperature

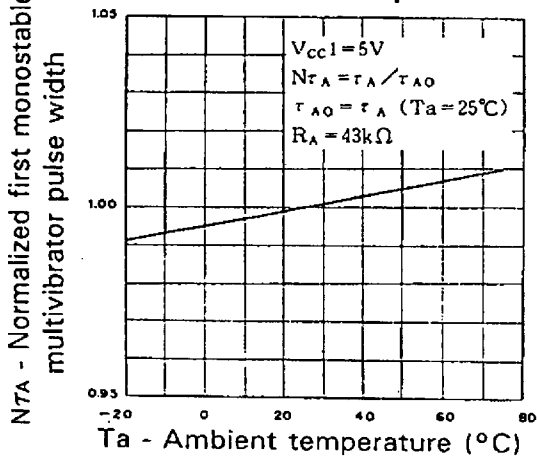

Normalized first monostable multivibrator pulse width NTA vs. Supply voltage

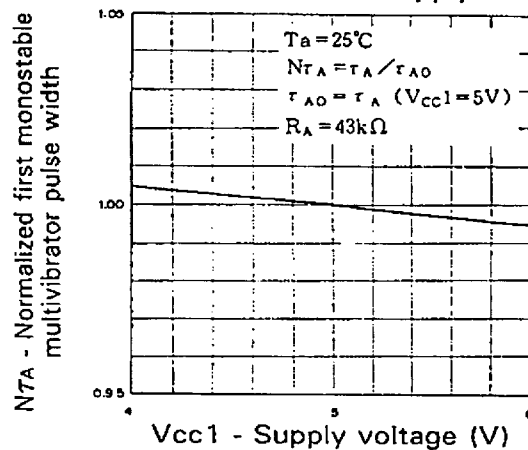

First monostable multivibrator
Pulse width τ_A vs. R_A

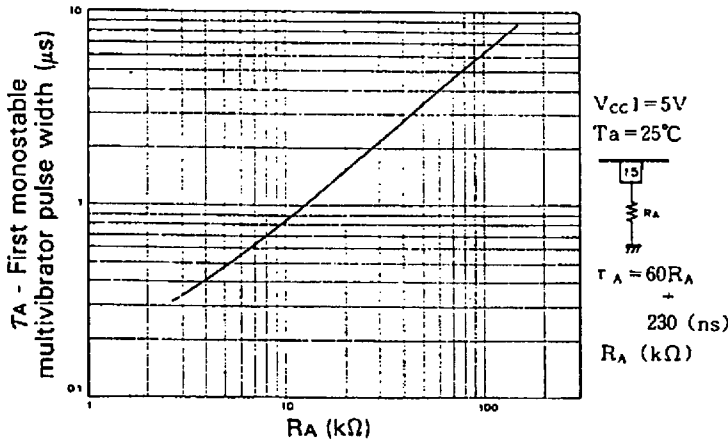

Normalized first monostable multivibrator pulse compensation width $N\tau_{AC}$ vs. Ambient temperature

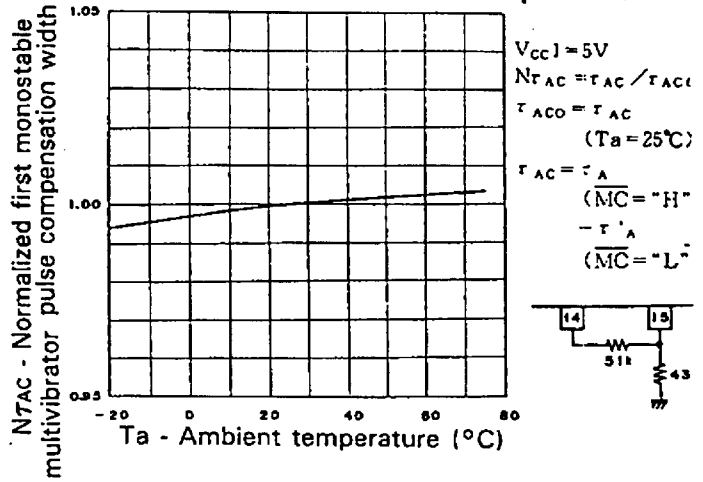

First monostable multivibrator pulse compensation width τ_{AC} vs. R_{AC}

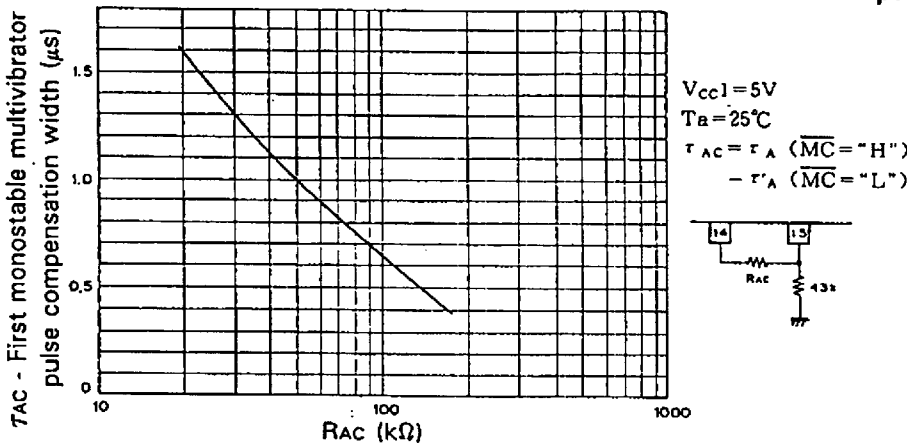

Normalized second monostable multivibrator pulse $N\tau_B$ vs. Ambient temperature

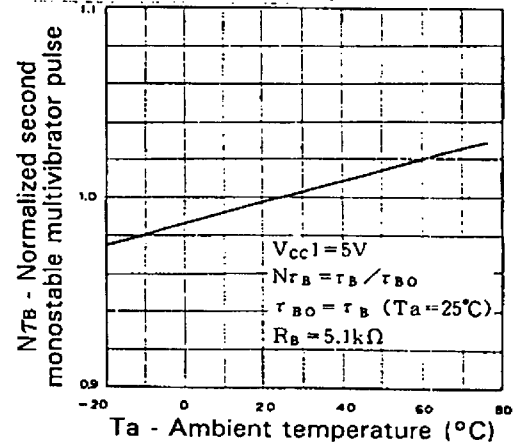

Normalized second monostable multivibrator pulse vs. Supply voltage

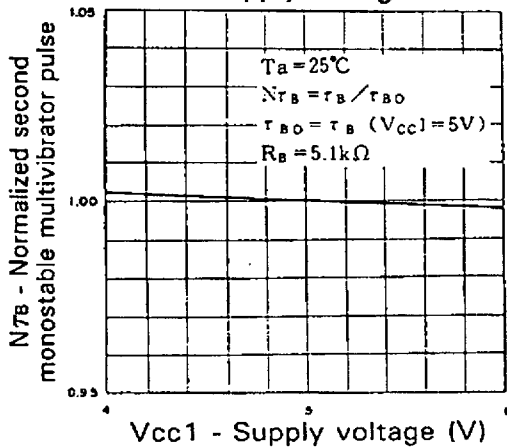

Second monostable multivibrator pulse vs. R_B

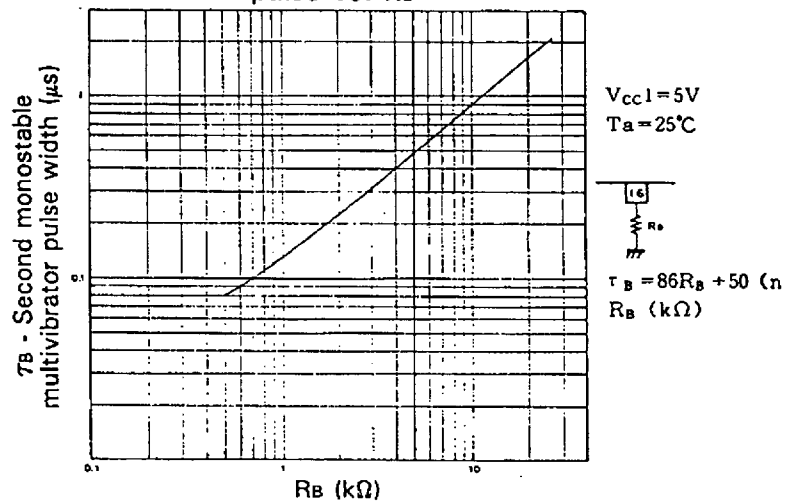

Normalized write current vs. Ambient temperature

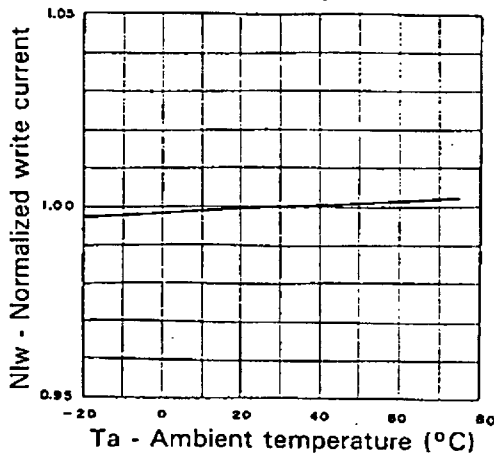

$V_{CC1} = 5V$
 $NI_w = I_w / I_{w0}$
 $I_{w0} = I_w (T_A = 25^\circ C)$

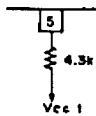

Normalized write current vs. Supply voltage

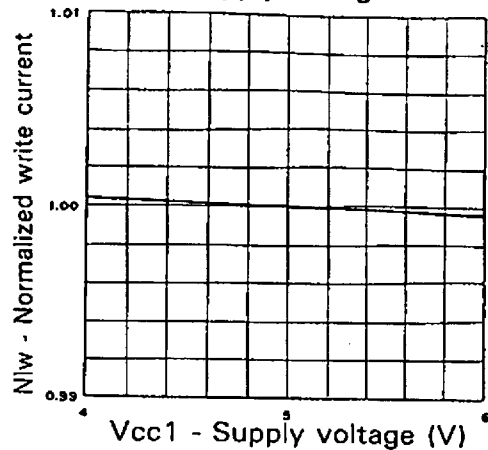

$T_A = 25^\circ C$
 $NI_w = I_w / I_{w0}$
 $I_{w0} = I_w (V_{CC1} = 5V)$

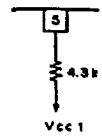

Write current vs. RW

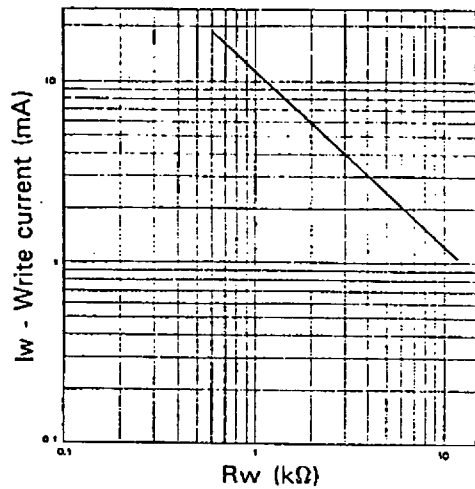

$V_{CC} = 5V$
 $T_A = 25^\circ C$

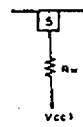

$I_w = 11.5 / R_{1w} + 0.20$ (mA)
 R_{1w} (kΩ)

Normalized write current compensation amount vs. Ambient temperature

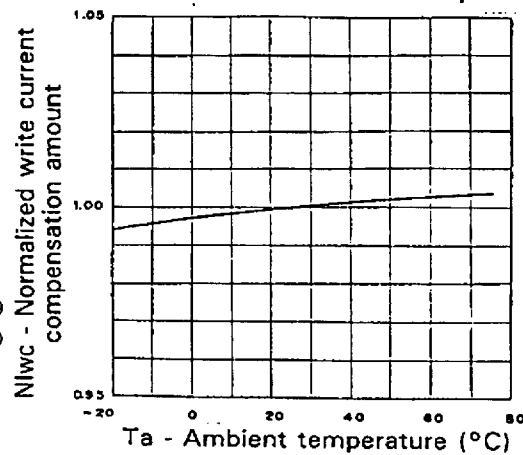

$V_{CC1} = 5V$
 $NI_{wc} = I_{wc} / I_{wc0}$
 $I_{wc0} = I_{wc} (T_A = 25^\circ C)$
 $I_{wc} = I_w'$
 (WC = "L")
 $-I_w$ (WC = "H")

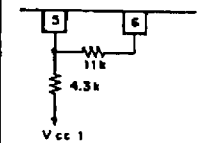

Write current compensation amount vs. RWC

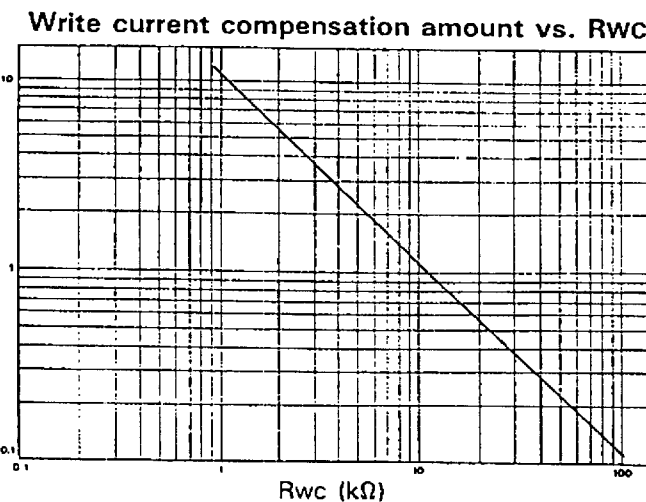

$V_{CC1} = 5V$
 $T_A = 25^\circ C$
 $I_{wc} = I_w' (WC = "L") - I_w (WC = "H")$

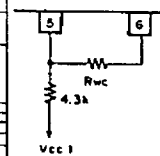

$I_{wc} = 11.2 / R_{wc}$ (mA)
 R_{wc} (kΩ)

Threshold voltage
vs. Ambient temperature

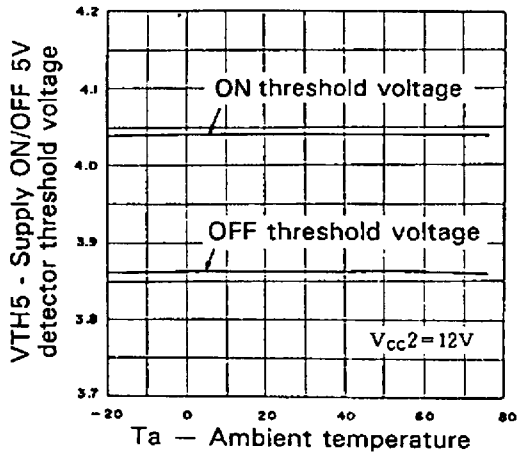

Supply ON/OFF 12V detector threshold voltage
vs. Ambient temperature

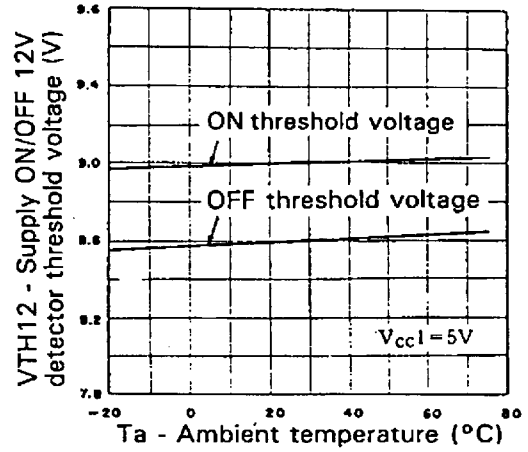

Package Outline : Unit : mm

CXA1073M 30pin SOP (Plastic) 375mil 0.7g

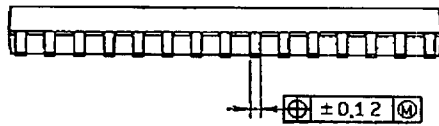
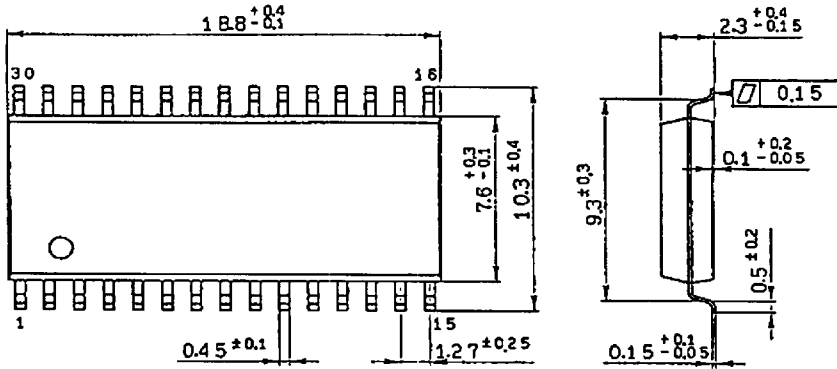

SONY NAME	SOP-30P-L01
EIAJ NAME	*SOP030-P-0375-A
JEDEC CODE	

CXA1073Q 32pin QFP (Plastic) 0.2g

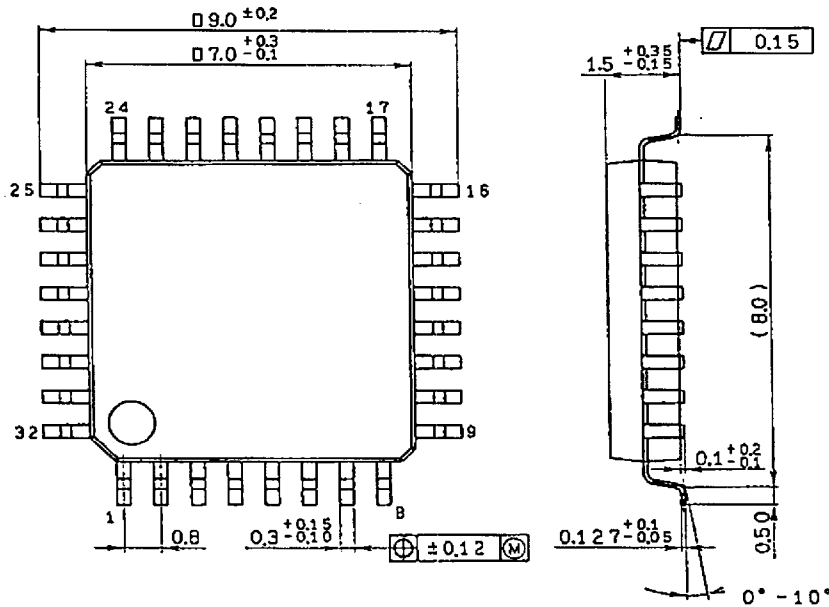

SONY NAME	QFP-32P-L01
EIAJ NAME	*QFP032-P-0707-A
JEDEC CODE	