



2911A-1 PCM CODEC—A LAW 8-BIT COMPANDED A/D AND D/A CONVERTER

- Per Channel, Single Chip Codec
- CCITT G711 and G732 Compatible, Even Order Bits Inversion Included
- Microcomputer Interface with On-Chip Time-Slot Computation
- Simple Direct Mode Interface When Fixed Timeslots Are Used
- ±5% Power Supplies: +12V, +5V, -5V
- 66 dB Dynamic Range, with Resolution Equivalent to 11-Bit Linear Conversion Around Zero
- Precision On-Chip Voltage Reference
- Low Power Consumption 230 mW Typ. Standby Power 33 mW Typ.
- Fabricated with Reliable N-Channel MOS Process

The Intel 2911A is a fully integrated PCM (Pulse Code Modulation) Codec (Coder-Decoder), fabricated with N-channel silicon gate technology. The high density of integration allows the sample and hold circuits, the digital-to-analog converter, the comparator and the successive approximation register to be integrated on the same chip, along with the logic necessary to interface a full duplex PCM link.

The primary applications are in telephone systems:

- Transmission — 30/32 Channel Systems at 2.048 Mbps
- Switching — Digital PBX's and Central Office Switching Systems
- Concentration — Subscriber Carrier/Concentrators

The wide dynamic range of the 2911A (66 dB) and the minimal conversion time (80 μ s minimum) make it an ideal product for other applications, like:

- Data Acquisition
- Telemetry
- Secure Communications Systems
- Signal Processing Systems

5

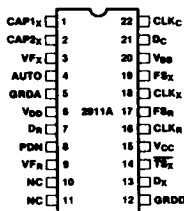

270158-1

Figure 1. Pin Configuration

CAP 1 _x , CAP 2 _x	Holding Capacitor
VF _x	Analog Input
VF _R	Analog Output
D _R , D _C	Digital Input
D _x , TS _x	Digital Output
CLK _C , CLK _x , CLK _R	Clock Input
FS _x , FS _R	Frame Sync Input
AUTO	Auto Zero Output
V _{BB}	Power (-5V)
V _{CC}	Power (+5V)
V _{DD}	Power (+12V)
PDN	Power Down
GRDA	Analog Ground
GRDD	Digital Ground
NC	No Connect

Figure 2. Pin Names

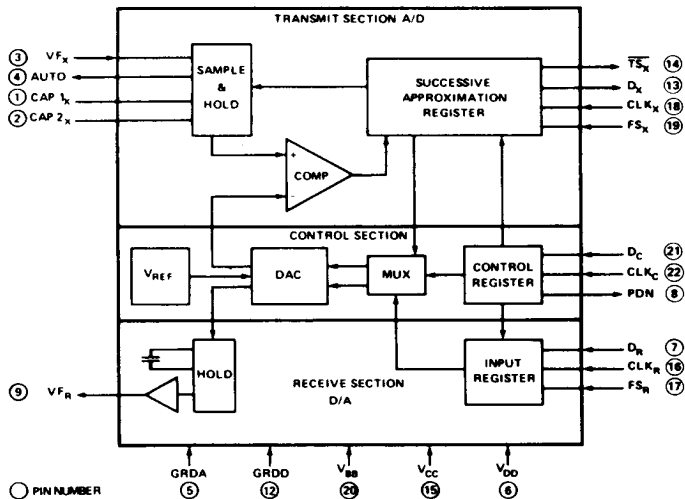

Figure 3. Block Diagram

270158-2

PIN DESCRIPTION

Pin No	Symbol	Function	Description
1	CAP1 _X	Hold	Connections for the transmit holding capacitor. Refer to Applications section.
2	CAP2 _X		
3	VF _X	Input	Analog input to be encoded into a PCM word. The signal on this lead is sampled at the same rate as the transmit frame synchronization pulse FS _X , and the sample value is held in the external capacitor connected to the CAP1 _X and CAP2 _X leads until the encoding process is completed.
4	AUTO	Output	Most significant bit of the encoded PCM word (+5V for negative, -5V for positive values). Refer to the Codec Applications section.
5	GRDA	Ground	Analog return common to the transmit and receive analog circuits. Not connected to GRDD internally.
6	V _{DD}	Power	+12V ±5%; referenced to GRDA.
7	D _R	Input	Receive PCM highway (serial bus) interface. The Codec serially receives a PCM word (8 bits) through this lead at the proper time defined by FS _R , CLK _R , D _C , and CLK _C .
8	PDN	Output	Active high when the Codec is in the power down state. Open drain output.
9	VF _R	Output	Analog Output. The voltage present on VF _R is the decoded value of the PCM word received on lead D _R . This value is held constant between two conversions.
10	NC	No Connects	Recommended practice is to strap these NC's to GRDA.
11	NC		
12	GRDD	Ground	Ground return common to the logic power supply; V _{CC} .
13	D _X	Output	Output of the transmit side onto the send PCM highway (serial bus). The 8-bit PCM word is serially sent out on this pin at the proper time defined by FS _X , CLK _X , D _C , and CLK _C . TTL three-state output.
14	\overline{TS}_X	Output	Normally high, this signal goes low while the Codec is transmitting an 8-bit PCM word on the D _X lead. (Timeslot information used for diagnostic purposes and also to gate the data on the D _X lead.) Open drain output.
15	V _{CC}	Power	+5V ±5%, referenced to GRDD.
16	CLK _R	Input	Master receive clock defining the bit rate on the receive PCM highway. Typically 2.048 Mbps for a carrier system. Maximum rate 2.1 Mbps. 50% duty cycle. TTL compatible.
17	FS _R	Input	Frame synchronization pulse for the receive PCM highway. Resets the on-chip timeslot counter for the receive side. Maximum repetition rate 12 KHz. TTL interface.
18	CLK _X	Input	Master transmit clock defining the bit rate on the transmit PCM highway. Typically 2.048 Mbps for a carrier system. Maximum rate 2.1 Mbps. 50% duty cycle. TTL interface.
19	FS _X	Input	Frame synchronization pulse for the transmit PCM highway. Resets the on-chip timeslot counter for the transmit side. Maximum repetition rate 12 KHz. TTL interface.
20	V _{BB}	Power	-5V ±5%, referenced to GRDA.
21	D _C	Input	Data input to program the Codec for the chosen mode of operation. Becomes an active low chip select when CLK _C is tied to V _{CC} . TTL interface.
22	CLK _C	Input	Clock input to clock in the data on the D _C lead when the timeslot assignment feature is used; tied to V _{CC} to disable this feature. TTL interface.

FUNCTIONAL DESCRIPTION

The 2911A PCM Codec provides the analog-to-digital and the digital-to-analog conversions necessary to interface a full duplex (4 wires) voice telephone circuit with the PCM highways of a time division multiplexed (TDM) system. The Codec is intended to be used on line and trunk terminations.

In a typical telephone system the Codec is located between the PCM highways and the channel filters.

The Codec encodes the incoming analog signal at the frame rate (FS_X) into an 8-bit PCM word which is sent out on the D_X lead at the proper time. Similarly, on the receive link, the Codec fetches an 8-bit PCM word from the receive highway (D_R lead) and decodes an analog value which will remain constant on lead VF_R until the next receive frame. Transmit and receive frames are independent. They can be asynchronous (transmission) or synchronous (switching) with each other.

Circuitry is provided within the Codec to internally define the transmit and receive timeslots. In small systems this may eliminate the need for any external timeslot exchange; in large systems it provides one level of concentration. This feature can be bypassed and discrete timeslots sent to each Codec within a system.

In the power-down mode, most functions of the Codec are directly disabled to reduce power dissipation to a minimum.

CODEC OPERATION

Codec Control

The operation of the 2911A is defined by serially loading an 8-bit word through the D_C lead (data) and the CLK_C lead (clock). The loading is synchronous with the other operations of the Codec, and takes place whenever transitions occur on the CLK_C lead. The D_C input is loaded in during the trailing edge of the CLK_C input.

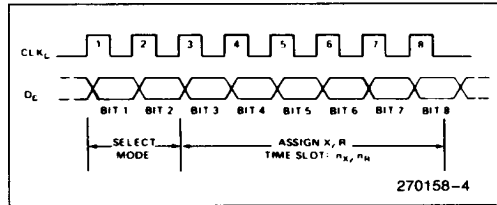

The control word contains two fields:

Bit 1 and Bit 2 define whether the subsequent 6 bits apply to both the transmit and receive side (00), the transmit side only (01), the receive side only (10), or whether the Codec should go into the standby, power-down mode (11). In the last case (11), the following 6 bits are irrelevant.

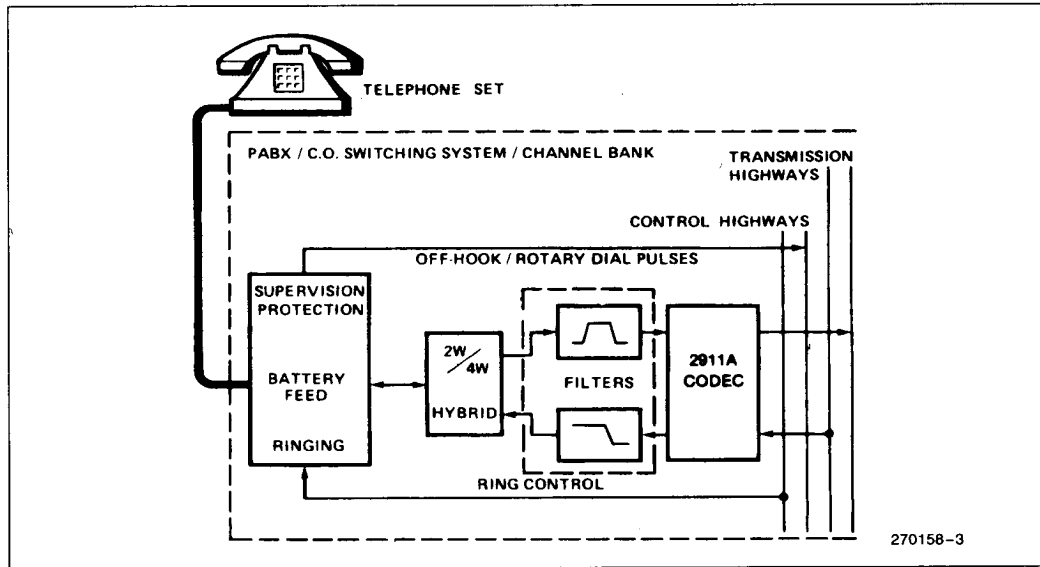

Figure 4. Typical Line Termination

The last 6 bits of the control word define the timeslot assignment, from 000000 (timeslot 1) to 111111 (timeslot 64). Bit 3 is the most significant bit and bit 8 the least significant bit and last into the Codec.

Bit 1	Bit 2	Mode
0	0	X & R
0	1	X
1	0	R
1	1	Standby

Bit						Time-Slot
3	4	5	6	7	8	
0	0	0	0	0	0	1
0	0	0	0	0	1	2
			.			.
			.			.
			.			.
1	1	1	1	1	1	64

The Codec will retain the control word (or words) until a new word is loaded in or until power is lost. This feature permits dynamic allocation of timeslots for switching applications.

Microcomputer Control Mode

In the microcomputer mode, each Codec performs its own timeslot computation independently for the transmit and receive channels by counting clock pulses (CLK_X and CLK_R). All Codecs tied to the same data bus receive identical framing pulses (FS_X and FS_R). The framing pulses reset the on-chip timeslot counters every frame; hence the timeslot counters of all devices are synchronized. Each Codec is programmed via CLK_C and D_C for the desired transmit and receive timeslots according to the description in the Codec Control Section. All Codecs tied to the same D_R bus will, in general, have different receive timeslots, although that is not a device requirement. There may be separate busses for transmit and receive or all Codecs may transmit and receive over the same bus, in which case the transmit and receive channels must be synchronous (CLK_X = CLK_R). There are no other restrictions on timeslot assignments; a device may have the same transmit and receive timeslot even if a single bus is used.

There are several requirements for using the CLK_C-D_C interface in the microcomputer mode.

1. A complete timeslot assignment, consisting of eight negative transitions of CLK_C, must be made in less than one frame period. The assignment

can overlap a framing pulse so long as all 8 control bits are clocked in within a total span of 125 μs (for an 8 KHz frame rate). CLK_C must be left at a TTL low level when not assigning a timeslot.

2. A dead period of two frames must always be observed between successive timeslot assignments. The two frame delay is measured from the rising edge of the first CLK_C transition of the previous timeslot assigned.
3. When the device is in the power-down state (Standby), the following three-step sequence must be followed to power-up the codec to avoid contention on the transmit PCM highway.
 - a. Assign a dummy transmit timeslot. The dummy should be at least two timeslots greater than the maximum valid system (usually 24 or 32). For example, in a 24 timeslot system, the dummy could be any timeslot between 26 and 64. This will power-up the transmit side, but prevent any spurious Dx or TSx outputs.
 - b. Two frames later, assign the desired transmit timeslot.
 - c. Two frames later assign the desired receive timeslot.
4. Initialization sequence: The device contains an on-chip power-on clear function which guarantees that with proper sequencing of the supplies (V_{CC} or V_{DD} on last), the device will initialize with no timeslot assigned to either the transmit or receive channel. After a supply failure or whenever the supplies are applied, it is recommended that either power down assignment be made first, or the first timeslot assignment be a transmit timeslot or a transmit/receive timeslot. The consequence of making a receive timeslot assignment first, after supply application, is that the transmit channel will assume timeslot 1, potentially producing bus contention.
5. Transmit only/receive only operation is permitted provided that a power down assignment is made first. Otherwise, special circuits which use only one channel should be physically disconnected from the unused bus; this allows a timeslot to be made to an unused channel without consequence.
6. Both frame synchronizing pulses (FS_X, FS_R) must be active at all times after power on clear (after power supplies are turned on). This requirement must be met during powerdown and receive only or transmit only operation, as well as during normal transmit and receive operation.

Example of Microcomputer Control Mode:

The two words 01000001 and 10000010 have been loaded into the Codec. The transmit side is now programmed for timeslot 2 and the receive side for

timeslot 3. The Codec will output a PCM word on the transmit PCM highway (bus) during the timeslot 2 of the transmit frame, and will fetch a PCM word from the receive PCM highway during timeslot 3.

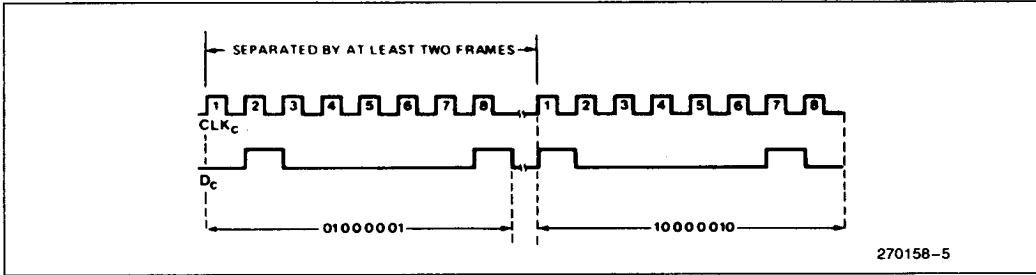

Figure 5. Microcomputer Mode Programming Examples

In this example the Codec interface to the PCM highway then functions as shown below. (FS_X and FS_R may be asynchronous.)

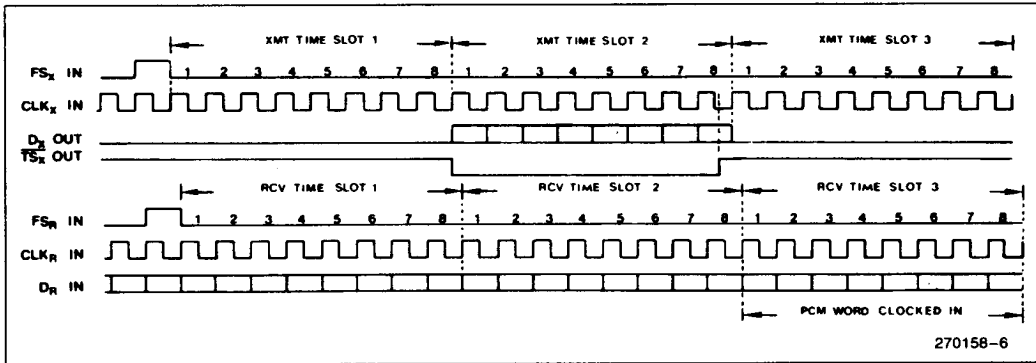

Figure 6. Microcomputer Mode PCM Highway Example

Direct Control Mode

The direct mode of operation will be selected when the CLK_C pin is strapped to the +5V supply (V_{CC}). In this mode, the D_C pin is an active low chip select. In other words, when D_C is low, the device transmits and receives in the timeslots which follow the appropriate framing pulses. With D_C high the device is in the power down state. Even though CLK_C characteristics are simpler for the 2911A it will operate properly when plugged into a 2911 board.

Deactivation of a channel by removal of the appropriate framing pulse (FS_X or FS_R) is not permitted.

Specifically, framing pulses must be applied for a minimum of two frames after a change in state of D_C in order for the D_C change to be internally sensed. In particular, when entering standby in the direct mode, framing pulses must be applied as usual for two frames after D_C is brought high.

The Codec will enter direct mode within three frame times ($375 \mu s$) as measured from the time the device power supplies settle to within the specified limits. This assumes that CLK_C is tied to V_{CC} and that all clocks are available at the time the supplies have settled.

General Control Requirements

All bit and frame clocks should be applied whenever the device is active. In particular, an unused channel cannot be deactivated by removal of its associated frame or bit clock while the other channel of the same device remains active.

A single channel cannot be deactivated except by physical disconnection of the data lead (D_X or D_R) from the system data bus. A device (both transmit and receive channels) may be deactivated in either control mode by powering down the device. Both channels are always powered down together.

Encoding

The VF signal to be encoded is input on the VF_X lead. An internal switch samples the signal and the hold function is performed by the external capacitor connected to the CAP1_X and CAP2_X leads. The

sampling and conversion is synchronized with the transmit timeslot. The PCM word is then output on the D_X lead at the proper timeslot occurrence of the following frame. The A/D converter saturates at approximately $\pm 2.2V$ RMS ($\pm 3.1V$ peak).

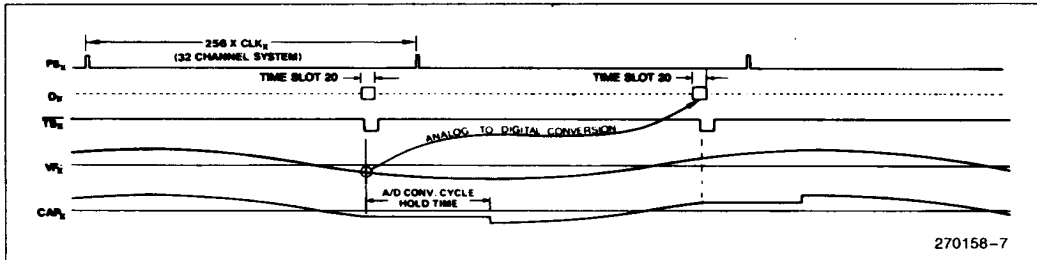

Figure 7. Transmit Encoding

Decoding

The PCM word is fetched by the D_R lead from the PCM highway at the proper timeslot occurrence. The decoded value is held on an internal sample and hold capacitor. The buffered non-return to zero output signal on the VF_R lead has a dynamic range of $\pm 2.2V$ RMS (± 3.1 volts peak).

Standby Mode—Power Down

To minimize power consumption and heat dissipation a standby mode is provided where all Codec functions are disabled except for D_C and CLK_C leads. These allow the Codec to be reactivated. In the microcomputer mode the Codec is placed into standby by loading a control word (D_C) with a "1" in bits 1 and 2 locations. In the direct mode when D_C is brought high, the all "1's" control word is internally transferred to the control register, invoking the standby condition.

While in the standby mode, the D_X output is actively held in a high impedance state to guarantee that the PCM bus will not be driven.

The power consumption in the standby mode is typically 33 mW.

Power-On Clear

Whether the device is used in the direct or microcomputer mode, an internal reset (power-on clear) is

generated, forcing the device into the power down state, when power is supplied by any of the following methods. (1) Device power supplies are turned on in a system power-up situation where either V_{CC} or V_{DD} is applied last. (2) A large supply transient causes either of the two positive supplies to drop to approximately 2V. (3) A board containing Codecs is plugged into a "hot" system where V_{CC} or V_{DD} is the last contact made. It may be necessary to trim back the edge connector pins or fingers on V_{CC} or V_{DD} relative to the other supply to guarantee that the power-on clear will operate properly when a board is plugged into a "hot" system. Furthermore, the Codec will inhibit activity on T_S_X and D_X during the application of power supplies.

The device is also tolerant of transients in the negative supply (V_{BB}) so long as V_{BB} remains more negative than $-3.5V$. V_{BB} transients which exceed this level should be detected and followed by a system reinitialization.

Precision Voltage Reference for the D/A Converter

The voltage reference is generated on the chip and is calibrated during the manufacturing process. The technique uses the difference in sub-surface charge density between two suitably implanted MOS devices to derive a temperature stable and bias stable reference voltage.

A gain setting op amp, programmed during manufacturing, "trims" the reference voltage source to the final precision voltage reference value provided to the D/A converter. The precision voltage reference determines the initial gain and dynamic range characteristics described in the A.C. Transmission Specification section.

CONVERSION LAW

The conversion law is commonly referred to as the A Law.

$$F(x) = \text{Sgn}(x) \left[\frac{1 + \log_{10} (A|x|)}{1 + \log_{10} A} \right], \quad 1/A \leq |x| \leq 1$$

$$F(x) = \text{Sgn}(x) \left[\frac{A|x|}{1 + \log_{10} A} \right], \quad 0 \leq |x| \leq 1/A$$

where: x = the input signal

Sgn(x) = sign of the input signal

A = 87.6 (defined by CCITT)

The Codec provides a piecewise linear approximation of the logarithmic law through 13 segments. Each segment is made of 16 steps with the exception of the first segment, which has 32 steps. In adjacent segments the step sizes are in a ratio of two to one. Within each segment, the step size is constant.

The output levels are midway between the corresponding decision levels. The output levels y_n are related to the input levels x_n by the expression:

$$y_n = \frac{x_{n-1} + x_n}{2}, \quad 0 < n \leq 128$$

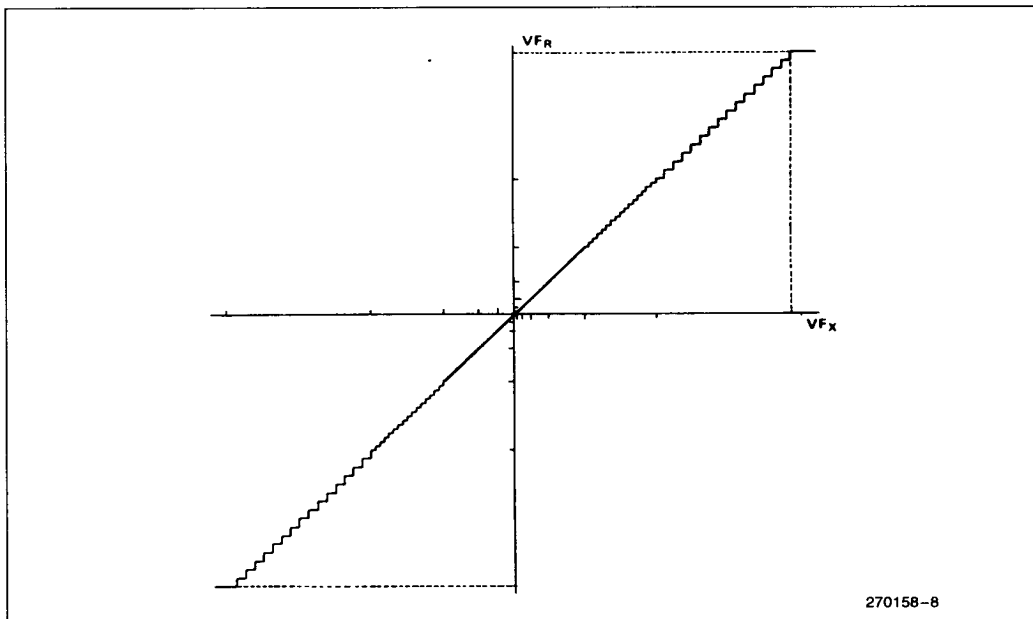

Figure 10. Codec Transfer Characteristic

Theoretical A-Law—Positive Input Values (for Negative Input Values, Invert Bit 1)

1 Segment Number	2 No. of Steps x Step Size	3 Value at Segment End Points	4 Decision Value Number n	5 Decision Value $x_n^{(1)}$	6 PCM Word ⁽⁴⁾		7 Normalized Value at Decoder Output $y_n^{(5)}$	8 Decoder Output Value Number
					Bit Number 1 2 3 4 5 6 7 8			
7	16 x 128	4096 ⁽³⁾	(128)	(4096)	1 1 1 1 1 1 1 1		4032	128
			127	3968	(Note 2)			
6	16 x 64	2048	113	2176	1 1 1 1 0 0 0 0		2112	113
			112	2048	(Note 2)			
5	16 x 32	1024	97	1088	1 1 1 0 0 0 0 0		1056	97
			96	1024	(Note 2)			
4	16 x 16	512	81	544	1 1 0 1 0 0 0 0		528	81
			80	512	(Note 2)			
3	16 x 8	256	65	272	1 1 0 0 0 0 0 0		264	65
			64	256	(Note 2)			
2	16 x 4	128	49	136	1 0 1 1 0 0 0 0		132	49
			48	128	(Note 2)			
1	32 x 2	64	33	68	1 0 1 0 0 0 0 0		66	33
			32	64	(Note 2)			
			1	2	1 0 0 0 0 0 0 0		1	1
			0	0	1 0 0 0 0 0 0 0		1	1

NOTES:

- 4096 normalized value units correspond to the value of the on-chip voltage reference.
- The PCM word corresponding to positive input values between two successive decision values numbered n and n + 1 (see column 4) is (128 + n) expressed as a binary number.
- X_{128} is a virtual decision value.
- The PCM word on the highways is the same as the one shown in column 6, with the even order bits inverted. The 2911A provides for the inversion of the even order bits on both the send and receive sections.
- The voltage output on the V_{FR} lead is equal to the normalized value given in the table, augmented by an offset. The offset value is approximately 15 mV.

APPLICATIONS

Holding Capacitor

For an 8 KHz sampling system the transmit holding capacitor CAP_X should be 2000 pF ±20%.

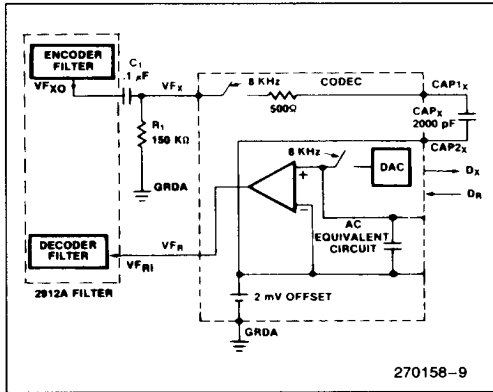

Figure 11. Circuit Interface—Without External Auto Zero

Filters Interface

The filters may be interfaced as shown in the circuit interface diagrams. Note that the output pulse stream is of the non-return-to-zero type and hence requires the (sin x)/x correction provided by the 2912A filter.

D_X Buffering

For higher drive capability or increased system reliability it may be desirable that the D_X output of a group of Codecs be buffered from the system PCM bus with an external three-state or open collector buffers. A buffer can be enabled with the appropriate Codec generated \overline{TS}_X signal or signals. \overline{TS}_X signal may also be used to activate external zero code suppression logic, since the occurrence of an active state of any \overline{TS}_X implies the existence of PCM voice bits (as opposed to transparent data bits) on the bus.

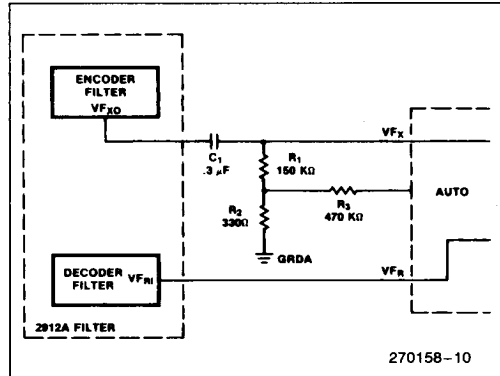

Figure 12. Circuit Interface—With External Auto Zero

Auto Zero

The 2911A contains a transparent on-chip auto zero plus a device pin for implementing a sign-bit driven external auto zero feedback loop. The on-chip auto zero reduces the input offset voltage of the encoder (VF_X) to less than 3 mV. For most telephony applications, this input offset is perfectly acceptable, since it insures the encoder is biased in the lower 25% of the first segment.

Where lower input offset is required the external auto zero loop may be used to bias the encoder exactly at the zero crossing point. The consequence of the external auto zero loop, aside from extra components, is the addition of the dithering auto-zero signal to the input signal, resulting in slightly higher idle channel noise (approximately 2 dB) than when the external loop is not used. Consequently, where the application permits, it is recommended that the external auto zero loop not be used. When not used, the AUTO pin should float.

The circuit interface with external auto zero drawing shows a possible connection between VF_X and AUTO leads with the recommended values of C₁=0.3 μF, R₁=150 KΩ, R₂=330Ω, and R₃=470 KΩ.

ABSOLUTE MAXIMUM RATINGS*

Temperature Under Bias -10°C to +80°C
 Storage Temperature -65°C to +150°C
 All Input or Output Voltages with
 Respect to V_{BB} -0.3V to +20V
 V_{CC}, V_{DD}, GRDA, and GRDA with Respect
 to V_{BB} -0.3V to +20V
 Power Dissipation 1.35W

NOTICE: This is a production data sheet. The specifications are subject to change without notice.

*WARNING: Stressing the device beyond the "Absolute Maximum Ratings" may cause permanent damage. These are stress ratings only. Operation beyond the "Operating Conditions" is not recommended and extended exposure beyond the "Operating Conditions" may affect device reliability.

D.C. CHARACTERISTICS

T_A = 0°C to +70°C, V_{DD} = +12V ±5%, V_{CC} = +5V ±5%, V_{BB} = -5V ±5%, GRDA = 0V, GRDD = 0V, unless otherwise specified.

DIGITAL INTERFACE

Symbol	Parameter	Limits			Unit	Test Conditions
		Min	Typ(1)	Max		
I _{IL}	Low Level Input Current			10	μA	V _{IN} < V _{IL}
I _{IH}	High Level Input Current			10	μA	V _{IN} > V _{IH}
V _{IL}	Input Low Voltage			0.6	V	
V _{IH}	Input High Voltage	2.2			V	
V _{OL}	Output Low Voltage			0.4	V	D _X , I _{OL} = 4.0 mA T _{SX} , I _{OL} = 3.2 mA, open drain PDN, I _{OL} = 1.6 mA, open drain
V _{OH}	Output High Voltage	2.4			V	D _X , I _{OH} = 15 mA

ANALOG INTERFACE

Symbol	Parameter	Limits			Unit	Test Conditions
		Min	Typ(1)	Max		
Z _{AI}	Input Impedance when Sampling, V _{F_X}	125	300	500	Ω	In series with CAP _X to GRDA, -3.1V < V _{IN} < 3.1V
Z _{AO}	Small Signal Output Impedance, V _{F_R}	100	180	300	Ω	-3.1V < V _{OUT} < 3.1V
V _{OR}	Output Offset Voltage at V _{F_R}	-50		50	mV	Minimum code to D _R
V _{IX}	Input Offset Voltage at V _{F_X}	-5		5	mV	Minimum positive code produced at D _X
V _{OL}	Output Low Voltage at AUTO		V _{BB}	(V _{BB} + 2)	V	400 KΩ to GRDA
V _{OH}	Output High Voltage at AUTO	(V _{CC} - 2)	V _{CC}		V	400 KΩ to GRDA

D.C. CHARACTERISTICS

$T_A = 0^\circ\text{C}$ to $+70^\circ\text{C}$, $V_{DD} = +12\text{V} \pm 5\%$, $V_{CC} = +5\text{V} \pm 5\%$, $V_{BB} = -5\text{V} \pm 5\%$, $GRDA = 0\text{V}$, $GRDD = 0\text{V}$, unless otherwise specified. (Continued)

POWER DISSIPATION

Symbol	Parameter	Limits			Unit	Test Conditions
		Min	Typ ⁽¹⁾	Max		
I_{DDO}	Standby Current		0.7	1.1	mA	Auto Output = Open Clock Frequency = 2.048 MHz
I_{CCO}	Standby Current		4.0	7.0	mA	
I_{BBO}	Standby Current		1.0	2.5	mA	
I_{DDI}	Operating Current		11	16	mA	
I_{CCI}	Operating Current		13	21	mA	
I_{BBI}	Operating Current		4.0	6.0	mA	

NOTE:

1. Typical values are for $T_A = 25^\circ\text{C}$ and nominal power supply values.

A.C. CHARACTERISTICS

$T_A = 0^\circ\text{C}$ to $+70^\circ\text{C}$, $V_{DD} = +12\text{V} \pm 5\%$, $V_{CC} = +5\text{V} \pm 5\%$, $V_{BB} = -5\text{V} \pm 5\%$, $GRDA = 0\text{V}$, $GRDD = 0\text{V}$, unless otherwise specified.

TRANSMISSION

Symbol	Parameter	Limits			Unit	Test Conditions
		Min	Typ ⁽¹⁾	Max		
S/D	Signal to Total Distortion Ratio. CCITT G.712 Method 2 (Half Channel)	37			dB	Signal level 0 dBm0 to -30 dBm0
		31			dB	Signal level to -40 dBm0
		26			dB	Signal level to -45 dBm0
ΔG	2911A Gain Tracking Deviation Half Channel ⁽³⁾ Reference Level -10 dBm0		± 0.25	± 0.30	dB	$V_{F_X} = 1.02\text{ KHz}$, sinusoid $-40\text{ dBm0} \leq V_{F_X} \leq +3\text{ dBm0}$
			± 0.60	± 0.70	dB	$-50\text{ dBm0} \leq V_{F_X} < -40\text{ dBm0}$
			± 1.5	± 1.8	dB	$-55\text{ dBm0} \leq V_{F_X} < -50\text{ dBm0}$
ΔG_V	ΔG Variation with Supplies Half Channel		± 0.0002	± 0.0004	dB/mV	$-40\text{ dBm0} \leq V_{F_X} \leq +3\text{ dBm0}$
			± 0.0004	± 0.0008	dB/mV	$-50\text{ dBm0} \leq V_{F_X} < -40\text{ dBm0}$
ΔG_T	ΔG Variation with Temperature Half Channel		± 0.001	± 0.002	dB/ $^\circ\text{C}$	$-40\text{ dBm0} \leq V_{F_X} \leq +3\text{ dBm0}$
			± 0.002	± 0.005	dB/ $^\circ\text{C}$	$-50\text{ dBm0} \leq V_{F_X} < -40\text{ dBm0}$
N_{IC}	Idle Channel Noise		-85	-78	dBm0p	Quiet Code. (Note 2)
HD	Harmonic Distortion (2nd or 3rd)		-48	-44	dB	$V_{F_X} = 1.02\text{ KHz}$, 0 dBm0; measured at decoder output V_{F_R}
IMD ₁ IMD ₂	Intermodulation Distortion G.712(7.1) G.712(7.2)			-45	dB	CCITT G.712
				-50	dBm0	Two Tone Method

A.C. CHARACTERISTICS

$T_A = 0^\circ\text{C}$ to $+70^\circ\text{C}$, $V_{DD} = +12\text{V} \pm 5\%$, $V_{CC} = +5\text{V} \pm 5\%$, $V_{BB} = -5\text{V} \pm 5\%$, $GRDA = 0\text{V}$, $GRDD = 0\text{V}$, unless otherwise specified. (Continued)

GAIN AND DYNAMIC RANGE

Symbol	Parameter	Limits			Unit	Test Conditions
		Min	Typ(1)	Max		
DmW	Digital Milliwatt Response	5.58	5.66	5.78	dBm	23°C, nominal supplies(4)
DmW _T	DmW _O Variation with Temperature		-0.001	-0.002	dB/°C	Relative to 23°C(4)
DmW _S	DmW _O Variation with Supplies			± 0.07	dB	Supplies ± 5%(4)
A _{IR}	Input Dynamic Range	2.183	2.213	2.243	V _{RMS}	Using D.C. and A.C. tests(5) 23°C, nominal supplies
A _{IRT}	Input Dynamic Range vs Temperature			-0.5	mV _{RMS} /°C	Relative to 23°C
A _{IRS}	Input Dynamic Range vs Supplies			± 18	mV _{RMS}	Supplies ± 5%
A _{OR}	Output Dynamic Range, V _{FR}	2.14	2.17	2.20	V _{RMS}	23°C, Nominal Supplies
A _{ORT}	A _{OR} Variation with Temperature			-0.5	mV _{RMS} /°C	Relative to 23°C
A _{ORS}	A _{OR} Variation with Supplies			± 18	mV _{RMS}	Supplies ± 5%

SUPPLY REJECTION AND CROSSTALK

Symbol	Parameter	Limits			Unit	Test Conditions
		Min	Typ(1)	Max		
PSRR ₁	V _{DD} Power Supply Rejection Ratio	45			dB	decoder alone(6)
PSRR ₂	V _{BB} Power Supply Rejection Ratio	35			dB	decoder alone(6)
PSRR ₃	V _{CC} Power Supply Rejection Ratio	50			dB	decoder alone(6)
PSRR ₄	V _{DD} Power Supply Rejection Ratio	50			dB	encoder alone(7)
PSRR ₅	V _{BB} Power Supply Rejection Ratio	45			dB	encoder alone(7)
PSRR ₆	V _{CC} Power Supply Rejection Ratio	50			dB	encoder alone(7)
CT _R	Crosstalk Isolation, Receive Side	75	80		dB	(Note 8)
CT _T	Crosstalk Isolation, Transmit Side	75	80		dB	(Note 9)
CAPX	Input Sample and Hold Capacitor	1600	2000	2400	pF	

NOTES:

1. Typical values are for $T_A = 25^\circ\text{C}$ and nominal power supply values.
2. If the external auto zero is used N_{IC} has a typical value of -76 dBm0.
3. Tested and guaranteed at 23°C, nominal supplies.
4. D_R of Device Under Test (D.U.T.) driven with repetitive digital word sequence specified in CCITT recommendation G.711. Measurement made at V_{FR} output.
5. With the D.C. method the positive and negative clipping levels are measured and A_{IR} is calculated. With the A.C. method a sinusoidal input signal to V_{FX} is used where A_{IR} is measured directly.
6. D.U.T. decoder; impose 200 mV_{PP}, 1.02 KHz on appropriate supply; measurement made at decoder output; decoder in idle channel conditions.
7. D.U.T. encoder; impose 200 mV_{PP}, 1.02 KHz on appropriate supply; measurement made at encoder output; encoder in idle channel conditions.
8. V_{FX} of D.U.T encoder = 1.02 KHz, 0 dBm0. Decoder under quiet channel conditions; measurements made at decoder output.
9. V_{FX} = 0 Vrms. Decoder = 1.02 KHz, 0 dBm0. Encoder under quiet channel conditions; measurement made at encoder output.

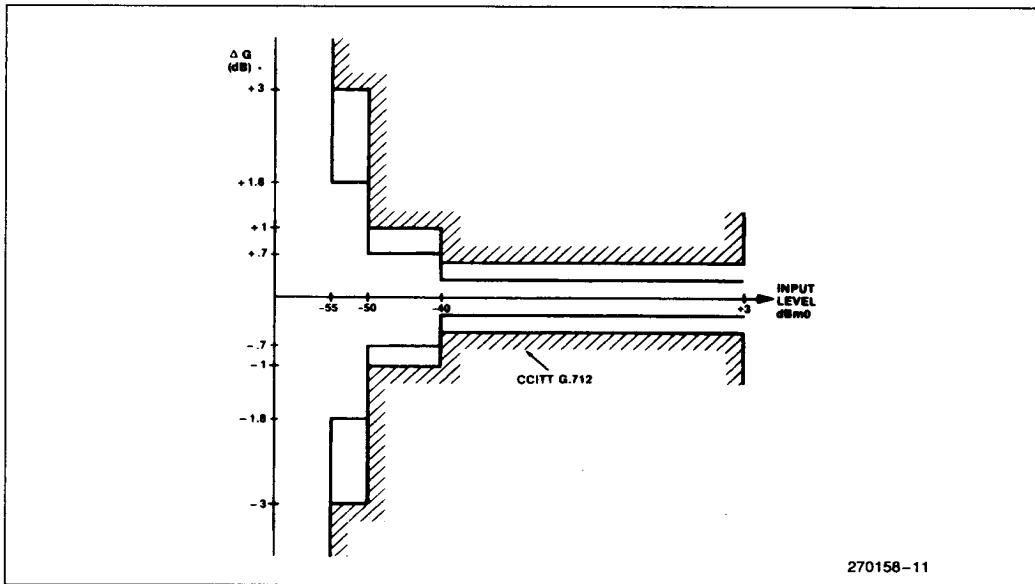

Figure 13. Tracking Deviation (ΔG) (Half Channel)

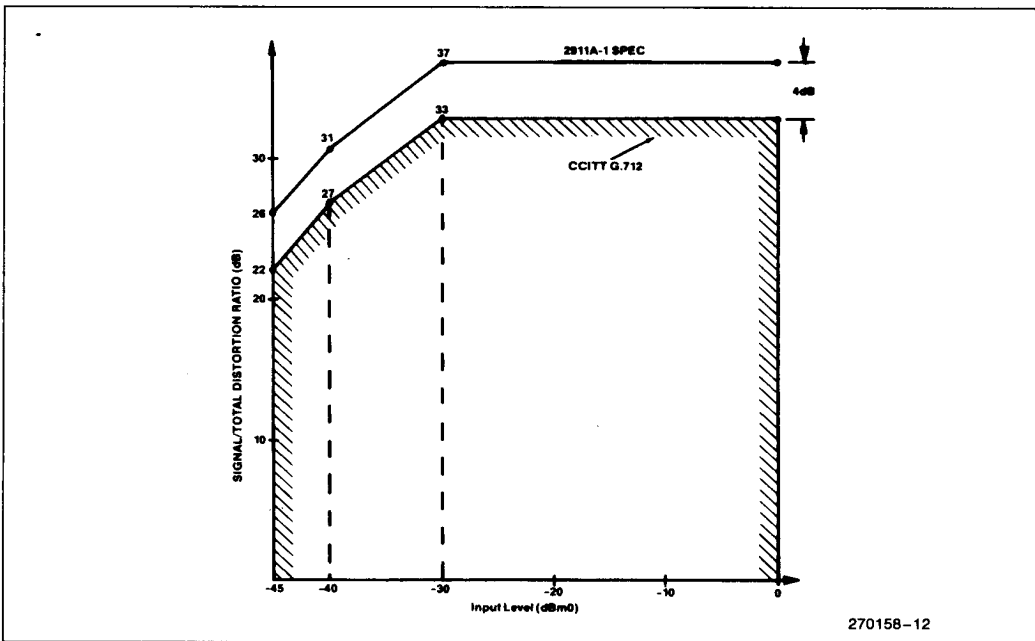

Figure 14. Signal to Total Distortion Ratio (Half Channel)

5

A.C. CHARACTERISTICS—TIMING SPECIFICATION(1)

$T_A = 0^\circ\text{C}$ to $+70^\circ\text{C}$, $V_{DD} = +12\text{V} \pm 5\%$, $V_{CC} = +5\text{V} \pm 5\%$, $V_{BB} = -5\text{V} \pm 5\%$, $GRDA = 0\text{V}$, $GRDD = 0\text{V}$, unless otherwise specified.

CLOCK SECTION

Symbol	Parameter	Limits		Unit	Comments
		Min	Max		
t_{CY}	Clock Period	485		ns	CLK_X , CLK_R (2.048 MHz systems), CLK_C
t_r , t_f	Clock Rise and Fall Time	0	30	ns	CLK_X , CLK_R , CLK_C
t_{CLK}	Clock Pulse Width	215		ns	CLK_X , CLK_R , CLK_C
t_{CDC}	Clock Duty Cycle ($t_{CLK} + t_{CY}$)	45	55	%	CLK_X , CLK_R

TRANSMIT SECTION

Symbol	Parameter	Limits		Unit	Comments
		Min	Max		
t_{VFX}	Analog Input Conversion	20		Timeslot	From Leading Edge of Transmit Timeslot(2)
t_{DZX}	Data Enabled on TS Entry	50	180	ns	$0 < C_{LOAD} < 100\text{ pF}$
t_{DHX}	Data Hold Time	80	230	ns	$0 < C_{LOAD} < 100\text{ pF}$
t_{HZX}	Data Float on TS Exit	75	245	ns	$C_{LOAD} = 0$
t_{SON}	Timeslot X to Enable	30	185	ns	$0 < C_{LOAD} < 100\text{ pF}$
t_{SOFF}	Timeslot X to Disable	70	225	ns	$C_{LOAD} = 0$
t_{FSD}	Frame Sync Delay	15	150	ns	

RECEIVE AND CONTROL SECTIONS

Symbol	Parameter	Limits		Unit	Comments
		Min	Max		
t_{VFR}	Analog Output Update	$9\frac{1}{16}$	$9\frac{1}{16}$	Timeslot	From Leading Edge of the Channel Timeslot
t_{DSR}	Receive Data Setup	20		ns	
t_{DHR}	Receive Data Hold	60		ns	
t_{FSD}	Frame Sync Delay	15	150	ns	
t_{DSC}	Control Data Setup	115		ns	Microcomputer Mode Only
t_{DHC}	Control Data Hold	115		ns	Microcomputer Mode Only

NOTES:

1. All timing parameters referenced to 1.5V, except t_{HZX} and t_{SOFF} , which reference a high impedance state.
2. The 20 timeslot minimum insures that the complete A/D conversion will take place under any combination of receive interrupt or asynchronous operation of the Codec. Consult an Intel applications specialist or Intel Corporation for applications information which would allow operation with less than 20 timeslots.

TIMING WAVEFORMS(1)

TRANSMIT TIMING

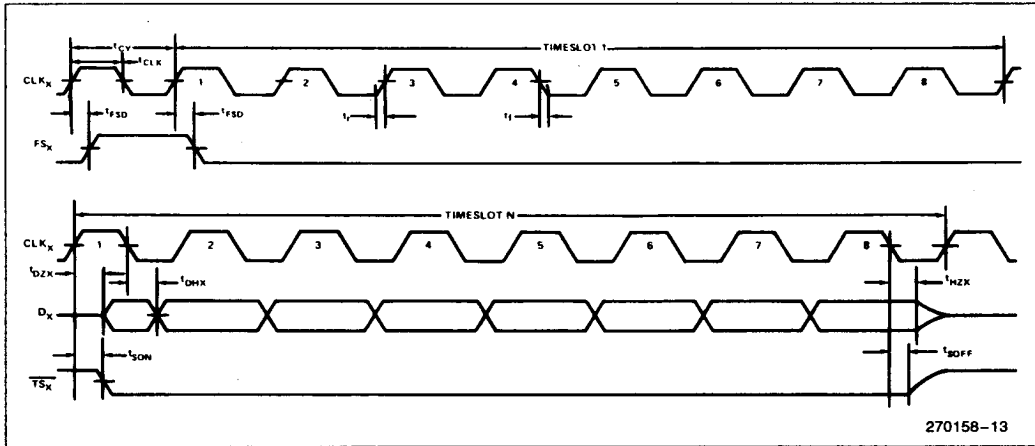

270158-13

RECEIVE TIMING

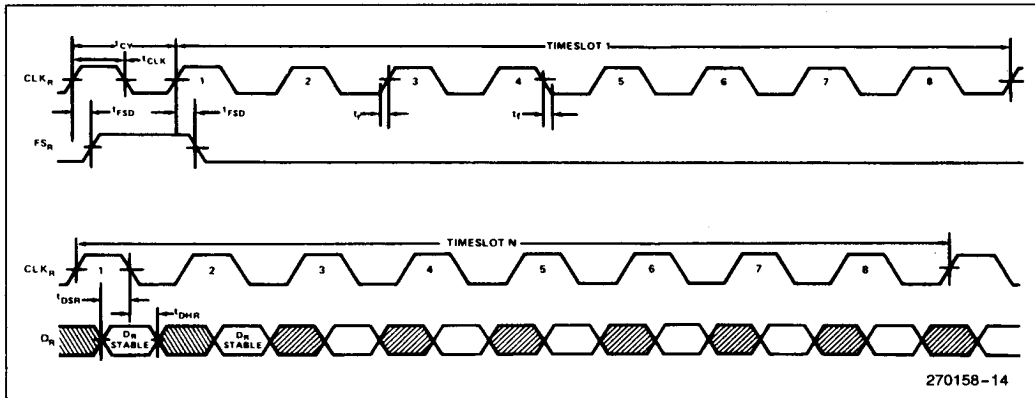

270158-14

CONTROL TIMING

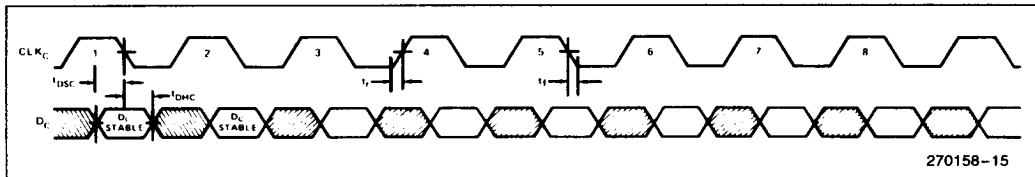

270158-15

NOTE:

1. All timing parameters referenced to 1.5V, except t_{HZX} and t_{SOFF} which reference a high impedance state.

5