

### FEATURES

- 16-Bit resolution
- 3 Output voltage ranges
- $\pm 15\text{ppm}/^\circ\text{C}$  maximum gain tempco
- Integral nonlinearity error  $\pm 0.003\%$ FSR, max.
- 14 Bits monotonic from  $+10^\circ\text{C}$  to  $+40^\circ\text{C}$
- High-reliability MIL-STD-883 models available

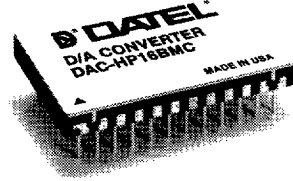

### GENERAL DESCRIPTION

The DAC-HP Series are high-resolution hybrid digital-to-analog converters with voltage outputs. The Series has 16-bit binary resolution with  $\pm 0.003\%$  integral nonlinearity. These units are self-contained, including a low-tempco Zener reference circuit and an output amplifier, in a miniature 24-pin DDIP package.

The DAC-HP Series offers both unipolar and bipolar modes with outputs of 0 to  $+10\text{V}$  and  $\pm 5\text{V}$  respectively. Devices with a bipolar output range of  $\pm 10\text{V}$  are also available and are designated with a "-1" suffix after the model designation. Input coding is complementary binary and complementary offset binary.

The DAC-HP design incorporates thin and thick-film hybrid technology. The design also includes an on-board amplifier and a precision Zener reference circuit. This eliminates code dependent ground currents by routing currents from the positive supply to the internal ground node as determined by the R-2R ladder network. The internal feedback resistors for the on-board amplifier track the ladder network resistors, enhancing temperature stability and performance. The excellent tracking of the resistors results in tempcos for differential nonlinearity, gain and zero of  $\pm 2$ ,  $\pm 15$  and  $\pm 5\text{ppm}/^\circ\text{C}$  max., respectively.

### INPUT/OUTPUT CONNECTIONS

PIN	FUNCTION	PIN	FUNCTION
1	BIT 1 (MSB)	24	REFERENCE OUT
2	BIT 2	23	+15V SUPPLY
3	BIT 3	22	GAIN ADJUST
4	BIT 4	21	SUMMING JUNCTION
5	BIT 5	20	GROUND
6	BIT 6	19	-15V SUPPLY
7	BIT 7	18	BIPOLAR OFFSET
8	BIT 8	17	OUTPUT
9	BIT 9	16	BIT 16 (LSB)
10	BIT 10	15	BIT 15
11	BIT 11	14	BIT 14
12	BIT 12	13	BIT 13

The DAC-HP Series operates off of  $\pm 15\text{V}$  supplies and offers models with temperature performance covering the 0 to  $+70^\circ\text{C}$  commercial or  $-55$  to  $+125^\circ\text{C}$  military temperature ranges. High reliability MIL-STD-883 versions are also available.

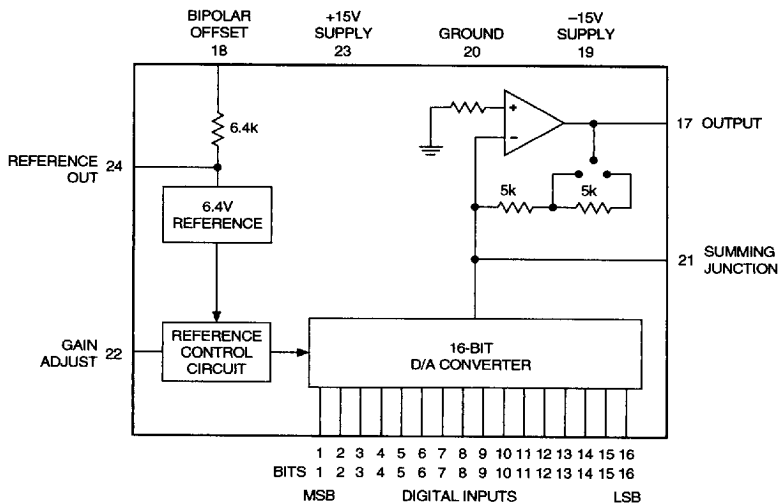

Figure 1. Functional Block Diagram

2651561 0003648 820

**ABSOLUTE MAXIMUM RATINGS**

Positive Supply, Pin 23	+18V
Negative Supply, Pin 19	-18V
Digital Input Voltage, Pins 1-16	+5.5V
Output Current, Pin 17	±20mA
Lead Temperature (soldering, 10s)	300°C

**FUNCTIONAL SPECIFICATIONS**

(Typical at +25°C and ±15V supplies unless otherwise noted.)

INPUTS	
Resolution	16 bits
Coding, Unipolar Output	Complementary binary
Coding, Bipolar Output	Complementary offset binary
Input Logic Level, Bit ON ("0") ①	0V to +0.8V at -1mA
Input Logic Level, Bit OFF ("1") ①	+2.4V to +5.5V at +40µA
Logic Loading	1 TTL load
PERFORMANCE ②	
Nonlinearity Error, max.	±0.003% of FSR
Monotonicity, +10°C to +40°C	14 bits
Gain Error, Before Trimming	±0.1%
Zero Error, Before Trimming	±0.1% of FSR
Gain Tempco, max. ③	±15ppm/°C of FSR
Gain Tempco, max. BGC	±20ppm/°C of FSR
Zero Tempco, Unipolar, max.	±5ppm/°C of FSR
Offset Tempco, Bipolar, max.	±8ppm/°C of FSR
Differential Nonlinearity Tempco, max.	±2ppm/°C of FSR
Settling Time, 10V Change ④	15µs
Slew Rate	±20V/µs
Power Supply Rejection	±0.003%FSR/% ⑤
OUTPUTS	
Output Voltage Range, Unipolar ⑥	0 to +10V
Output Voltage Range, Bipolar	±5V
Output Voltage Range, "-1" Suffix	±10V
Output Current, min. ⑦	±5mA
Output Impedance	0.05Ω
POWER REQUIREMENTS	
Quiescent, All Bits High	+15V, ±0.5V at 20mA -15V, ±0.5V at 25mA ±12V operation ⑧
PHYSICAL ENVIRONMENTAL	
Operating Temperature Range, Case	0°C to +70°C (BMC, BGC) -55°C to +125°C (BMM, 883)
Storage Temperature Range	-65°C to +150°C
Package Type	24-pin DDIP
Weight	0.22 ounces (6.3 grams)

**Footnotes**

- ① Drive from TTL output with only the DAC-HP as load.
- ② FSR is full-scale range and is 10V for 0 to +10V or -5V to +5V outputs, 20V for ±10V output, etc
- ③ For all models except DAC-HP16BGC
- ④ Settling to ±0.5mV
- ⑤ ±0.006%FSR/% maximum over full military temperature range for MM and 883 models.
- ⑥ Unipolar output range for suffix "-1" models, 0 to +10V, is reached at the 1/2 scale point.
- ⑦ Pin 17.
- ⑧ For ±12V operation, consult factory.

**TECHNICAL NOTES**

1. It is recommended that these converters be operated with local supply bypass capacitors of 1µF (tantalum type) at the +15V and -15V supply pins. The capacitors should be connected as close to the pins as possible. In high-frequency noise environments, an additional 0.01µF ceramic capacitor should be used in parallel with each tantalum bypass.
2. When laying out the circuit board for this device, isolate the analog, digital and power grounds as much as possible from each other before joining them at pin 20.
3. If the reference output (pin 24) is used, it must be buffered by an operational amplifier in the noninverting mode. See Figure 2. Current drawn from pin 24 should be limited to ±10µA in order that the temperature coefficient of the reference circuit not be affected. This is sufficient current for the bias current requirements of most popular operational amplifier types.

**CALIBRATION PROCEDURE**

For bipolar operation, connect Bipolar Offset (pin 18) to Summing Junction (pin 21). For unipolar operation, connect Bipolar Offset (pin 18) to Ground (pin 20). In making the following adjustments, refer to the Coding Tables and Connection Diagrams.

1. **Zero Adjustment.** Set the input digital code to 1111 1111 1111 1111 and adjust the ZERO ADJ. potentiometer to give 0.00000V output for unipolar operation or -FS output for bipolar operation.
2. **Gain Adjustment.** Set the input digital code to 0000 0000 0000 0000 and adjust the GAIN ADJ. potentiometer to give +FS - 1LSB output for either unipolar or bipolar operation.

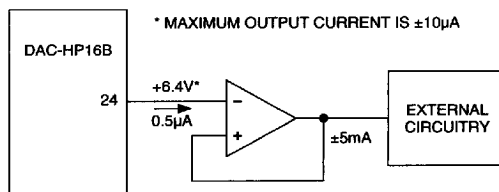

Figure 2. Use of Reference Output

2651561 0003649 767

**CODING TABLES**

**Table 1. Bipolar Output — Complementary Offset Binary**

INPUT CODE				SCALE	OUTPUT VOLTAGE	OUTPUT VOLTAGE SUFFIX "-1"
MSB			LSB			
0000	0000	0000	0000	+FS - 1LSB	+4.99985V	+9.99969V
0011	1111	1111	1111	+1/2FS	+2.50000	+5.00000
0111	1111	1111	1111	0	0.00000	0.00000
1011	1111	1111	1111	-1/2FS	-2.50000	-5.00000
1111	1111	1111	1110	-FS + 1LSB	-4.99985	-9.99969
1111	1111	1111	1111	-FS	-5.00000V	-10.00000V

**Table 2. Unipolar Output — Complementary Binary**

INPUT CODE				SCALE	OUTPUT VOLTAGE
MSB			LSB		
0000	0000	0000	0000	+FS - 1LSB	+9.99985V
0011	1111	1111	1111	+3/4FS	+7.50000
0111	1111	1111	1111	+1/2FS	+5.00000
1011	1111	1111	1111	+1/4FS	+2.50000
1111	1111	1111	1110	+1LSB	+153μV
1111	1111	1111	1111	0	0

**CONNECTION DIAGRAMS**

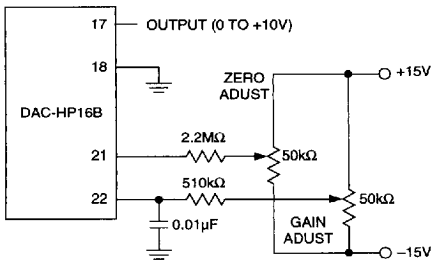

**Figure 3. Unipolar Operations**

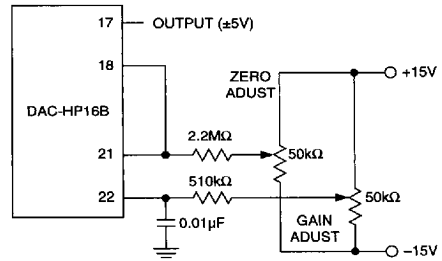

**Figure 4. Bipolar Operations**

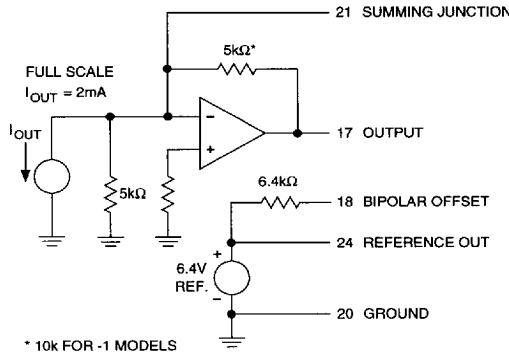
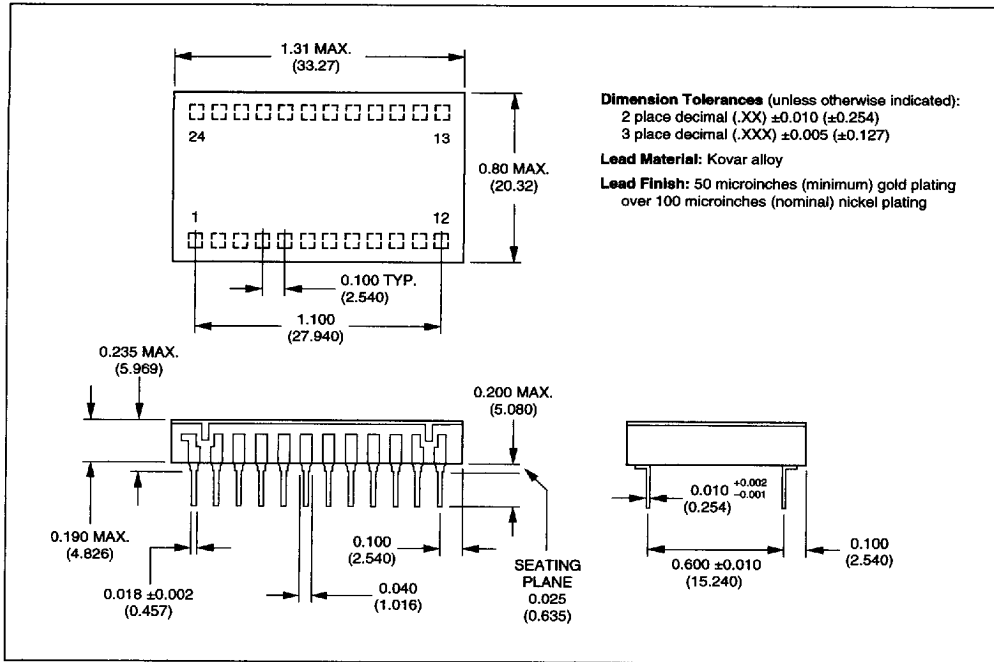

**Figure 5. Output Circuit**

6

2651561 0003650 489

**MECHANICAL DIMENSIONS** Inches (mm)



**ORDERING INFORMATION**

MODEL NUMBER	OPERATING TEMP. RANGE
DAC-HP16BGC	0 to +70°C
DAC-HP16BMC	0 to +70°C
DAC-HP16BMM	-55 to +125°C
DAC-HPB/883	-55 to +125°C
DAC-HP16BGC-1	0 to +70°C
DAC-HP16BMC-1	0 to +70°C
DAC-HP16BMM-1	-55 to +125°C
DAC-HPB-1/883	-55 to +125°C

The MIL-STD-883 units are available under DESC Drawing Number 5962-89531. Contact DATEL for 883 product specifications.

2651561 0003651 315