

6 PIN DIP PHOTOTRANSISTOR AC INPUT PHOTOCOUPLER

H11AAX Series

Features

- H11AAX series: H11AA1, H11AA2, H11AA3, H11AA4
- High isolation voltage between input and output
Viso = 5000 Vrms
- Creepage distance >7.62 mm
- Compact dual-in-line package
- Pb free and RoHS compliant.
- UL approved (No. E214129)
- VDE approval pending
- SEMKO approval pending
- NEMKO approval pending
- DEMKO approval pending
- FIMKO approval pending
- CSA approval pending

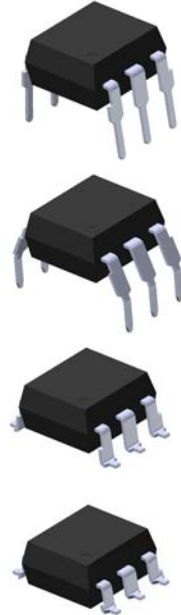

Description

The H11AAX series of devices each consist of two infrared emitting diode, connected in inverse parallel, optically coupled to a phototransistor detector.

They are packaged in a 6-pin DIP package and available in wide-lead spacing and SMD option.

Applications

- AC line monitor
- Unknown polarity DC sensor
- Telephone line interface

Schematic

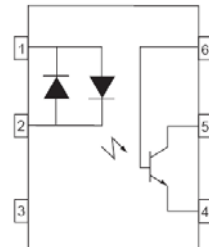

1. Anode / Cathode
2. Cathode / Anode
3. No Connection
4. Emitter
5. Collector
6. Base

6 PIN DIP PHOTOTRANSISTOR AC INPUT PHOTOCOUPLER

H11AAX Series

Absolute Maximum Ratings ($T_a=25^{\circ}\text{C}$)

Parameter		Symbol	Rating	Unit
Input	Forward current	I_F	60	mA
	Peak forward current ($t = 10\mu\text{s}$)	I_{FM}	1	A
	Power dissipation ($T_A = 25^{\circ}\text{C}$)	P_D	120	mW
	Derating factor (above 90°C)		3.8	mW/ $^{\circ}\text{C}$
Output	Power dissipation ($T_A = 25^{\circ}\text{C}$) No derating up to 100°C	P_C	150	mW
	Collector-Emitter voltage	V_{CEO}	80	V
	Collector-Base voltage	V_{CBO}	80	V
	Emitter-Collector voltage	V_{ECO}	7	V
Total power dissipation		P_{tot}	200	mW
Isolation voltage ^{*1}		V_{iso}	5000	V _{rms}
Operating temperature		T_{opr}	-55~+100	$^{\circ}\text{C}$
Storage temperature		T_{stg}	-55~+125	$^{\circ}\text{C}$
Soldering temperature ^{*2}		T_{sol}	260	$^{\circ}\text{C}$

Notes

*1 AC for 1 minute, R.H.= 40 ~ 60% R.H. In this test, pins 1, 2 & 3 are shorted together, and pins 4, 5 & 6 are shorted together.

*2 For 10 seconds.

6 PIN DIP PHOTOTRANSISTOR AC INPUT PHOTOCOUPLER

H11AAX Series

Electrical Characteristics ($T_a=25^\circ\text{C}$ unless specified otherwise)

Input

Parameter	Symbol	Min.	Typ.*	Max.	Unit	Condition
Forward voltage	V_F	-	1.2	1.5	V	$I_F = \pm 10\text{mA}$
Input capacitance	C_{in}	-	80	-	pF	$V = 0, f = 1\text{MHz}$

Output

Parameter	Symbol	Min.	Typ.*	Max.	Unit	Condition
Collector-Emitter dark current	I_{CEO}	-	-	50	nA	$V_{CE} = 10\text{V}, I_F = 0\text{mA}$
Collector-Emitter breakdown voltage	BV_{CEO}	80	-	-	V	$I_C = 1\text{mA}$
Collector-Base breakdown voltage	BV_{CBO}	80	-	-	V	$I_C = 0.1\text{mA}$
Emitter-Collector breakdown voltage	BV_{ECO}	7	-	-	V	$I_E = 0.1\text{mA}$
Collector-Emitter capacitance	C_{CE}	-	10	-	pF	$V_{CE} = 0\text{V}, f = 1\text{MHz}$

Transfer Characteristics

Parameter	Symbol	Min.	Typ.*	Max.	Unit	Condition	
Current Transfer Ratio	H11AA1	CTR	20	-	-	%	$I_F = \pm 10\text{mA}, V_{CE} = 10\text{V}$
	H11AA2		10	-	-		
	H11AA3		50	-	-		
	H11AA4		100	-	-		
CTR Symmetry		0.5	-	2.0		$I_F = \pm 10\text{mA}, V_{CE} = 10\text{V}$	
Collector-emitter saturation voltage	$V_{CE(sat)}$	-	-	0.4	V	$I_F = \pm 10\text{mA}, I_C = 0.5\text{mA}$	
Isolation resistance	R_{IO}	10^{11}	-	-	Ω	$V_{IO} = 500\text{Vdc}$	
Input-output capacitance	C_{IO}	-	0.7	-	pF	$V_{IO} = 0, f = 1\text{MHz}$	
Turn-on time	T_{on}	-	-	10	μs	$V_{CC} = 10\text{V}, I_C = 10\text{mA}, R_L = 100\Omega$	
Turn-off time	T_{off}	-	-	10			
Rise time	T_r	-	-	10			
Fall time	T_f	-	-	10			

* Typical values at $T_a = 25^\circ\text{C}$



LIGHTING FOREVER

6 PIN DIP PHOTOTRANSISTOR AC INPUT PHOTOCOUPLER

H11AAX Series

Typical Performance Curves

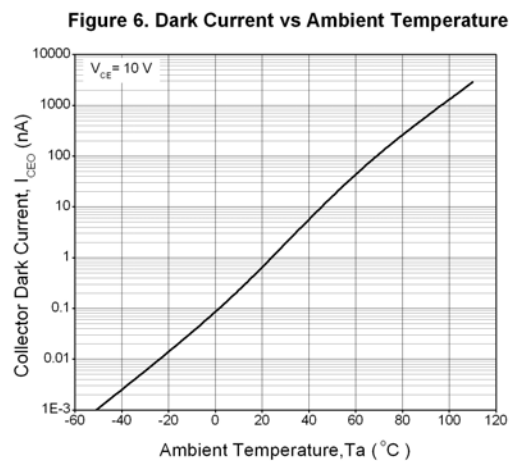
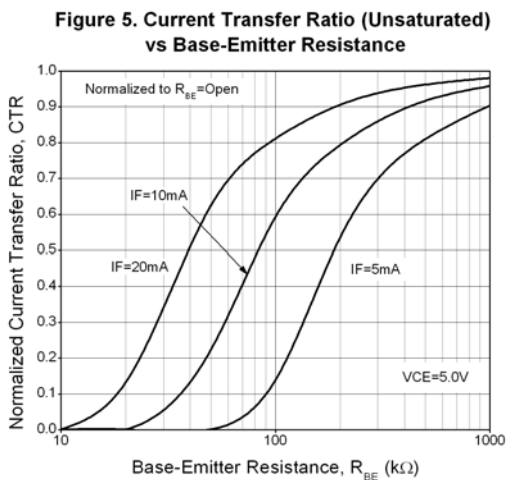
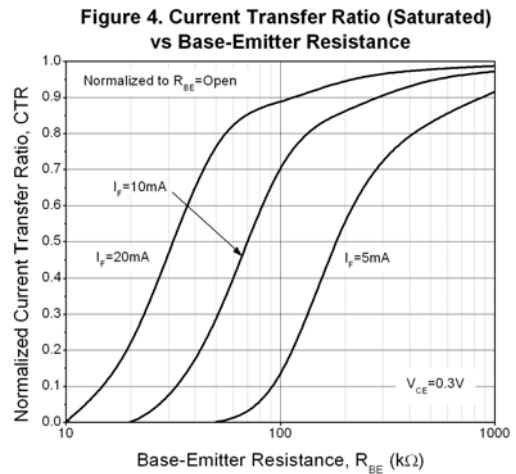
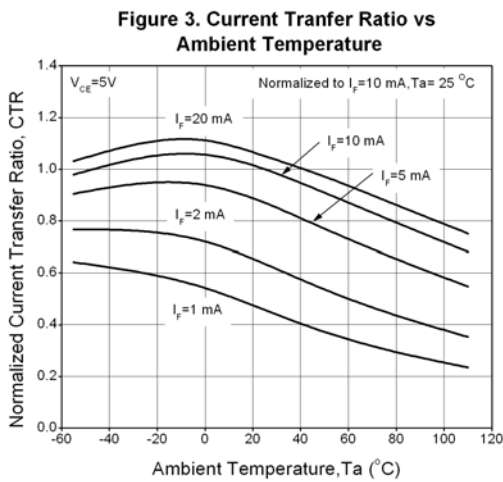
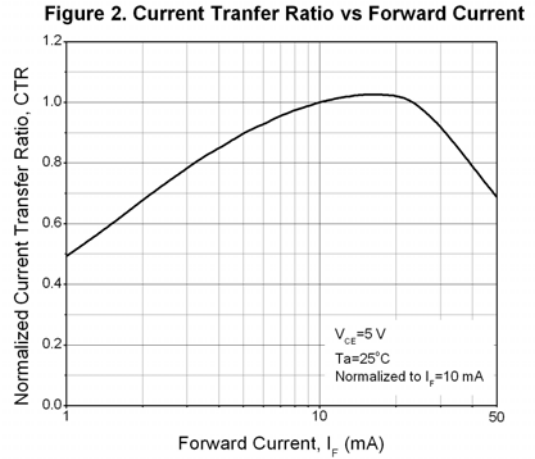
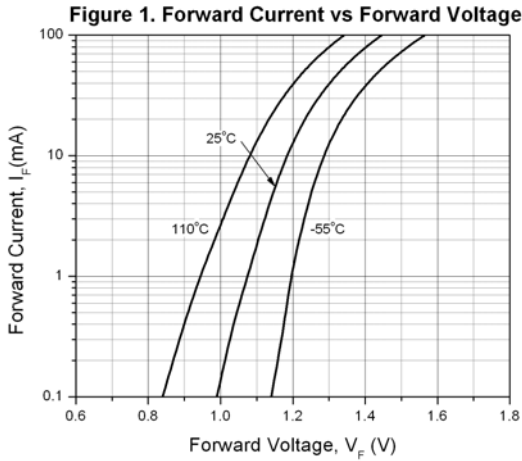

6 PIN DIP PHOTOTRANSISTOR AC INPUT PHOTOCOUPLER

H11AAX Series

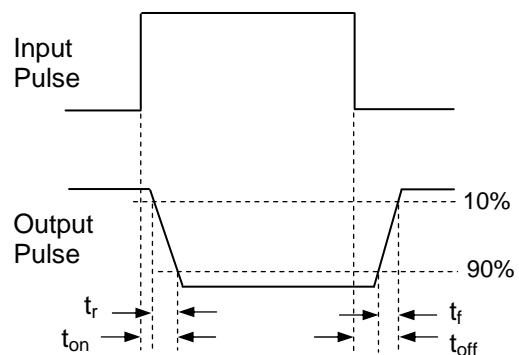
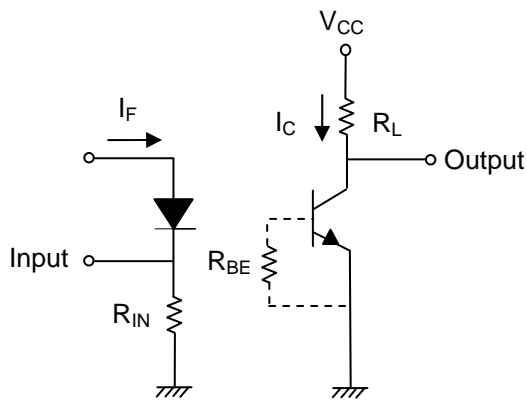
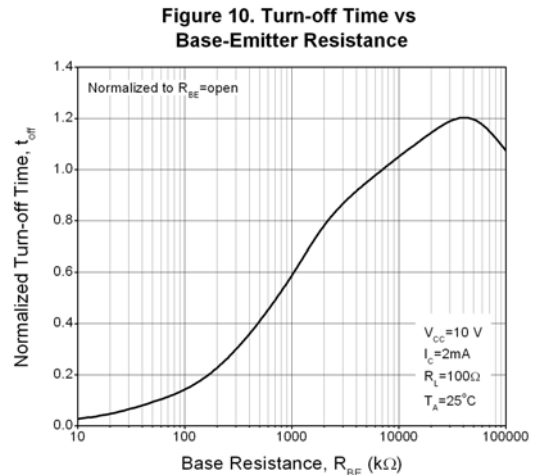
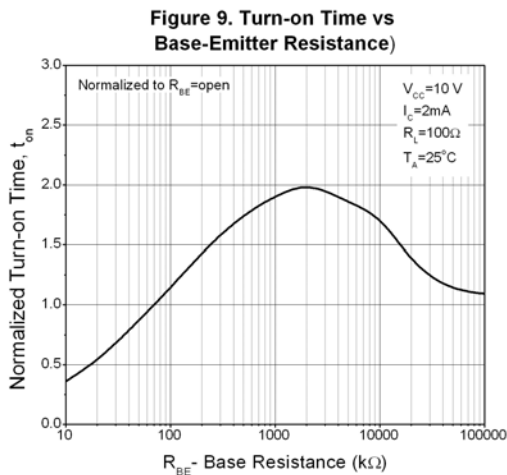
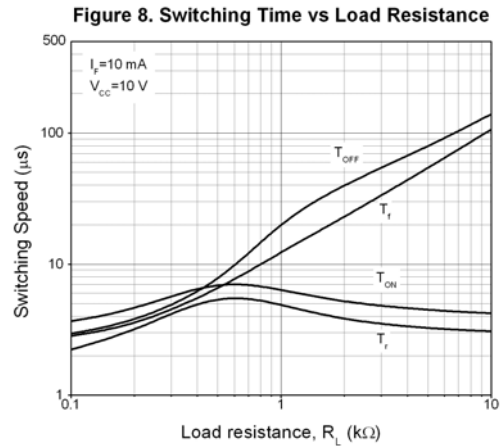
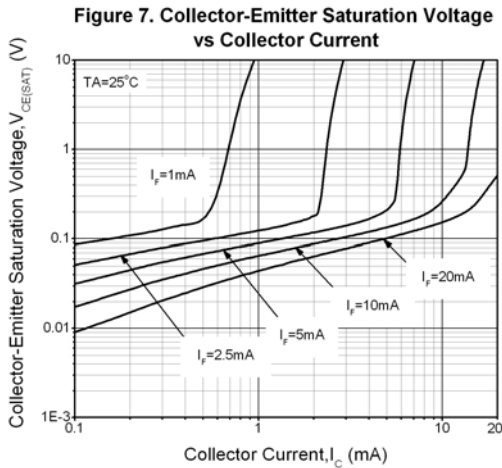

Figure 11. Switching Time Test Circuit & Waveforms



LIGHTING FOREVER

6 PIN DIP PHOTOTRANSISTOR AC INPUT PHOTOCOUPLER

H11AAX Series

Order Information

Part Number

H11AAXY(Z)-V

Note

X = Part no. (1, 2, 3 or 4)

Y = Lead form option (S, S1, M or none)

Z = Tape and reel option (TA, TB or none).

V= VDE safety (optional)

Option	Description	Packing quantity
None	Standard DIP-6	65 units per tube
M	Wide lead bend (0.4 inch spacing)	65 units per tube
S (TA)	Surface mount lead form + TA tape & reel option	1000 units per reel
S (TB)	Surface mount lead form + TB tape & reel option	1000 units per reel
S1 (TA)	Surface mount lead form (low profile) + TA tape & reel option	1000 units per reel
S1 (TB)	Surface mount lead form (low profile) + TB tape & reel option	1000 units per reel



LIGHTING FOREVER

6 PIN DIP PHOTOTRANSISTOR AC INPUT PHOTOCOUPLER

H11AAX Series

Package Drawings

(Dimensions in mm)

Standard DIP Type

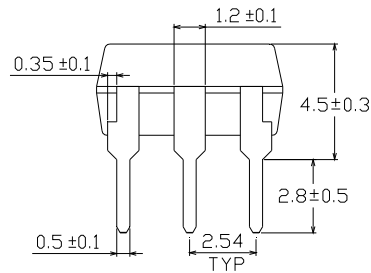
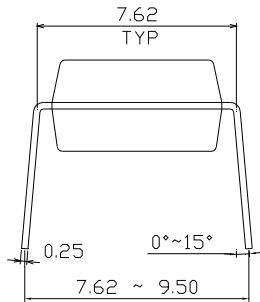
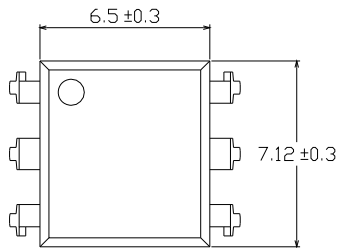

Option M Type

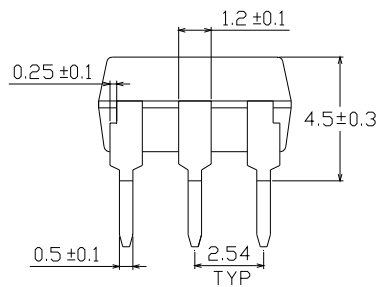
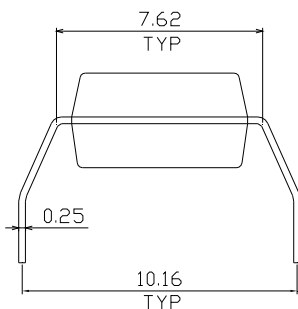
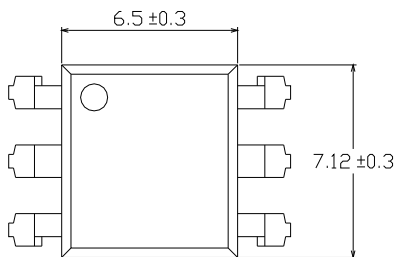



LIGHTING FOREVER

6 PIN DIP PHOTOTRANSISTOR AC INPUT PHOTOCOUPLER

H11AAX Series

Option S Type

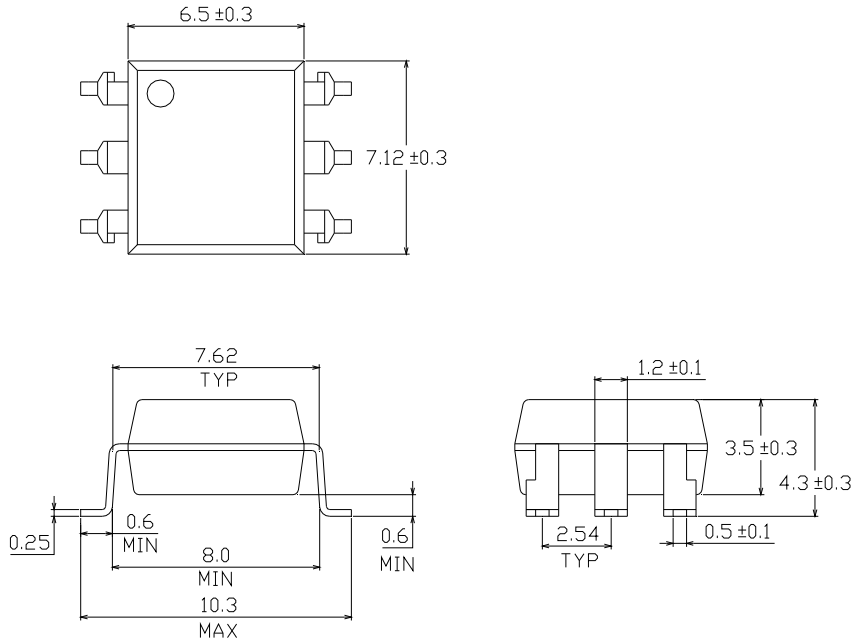

Option S1 Type

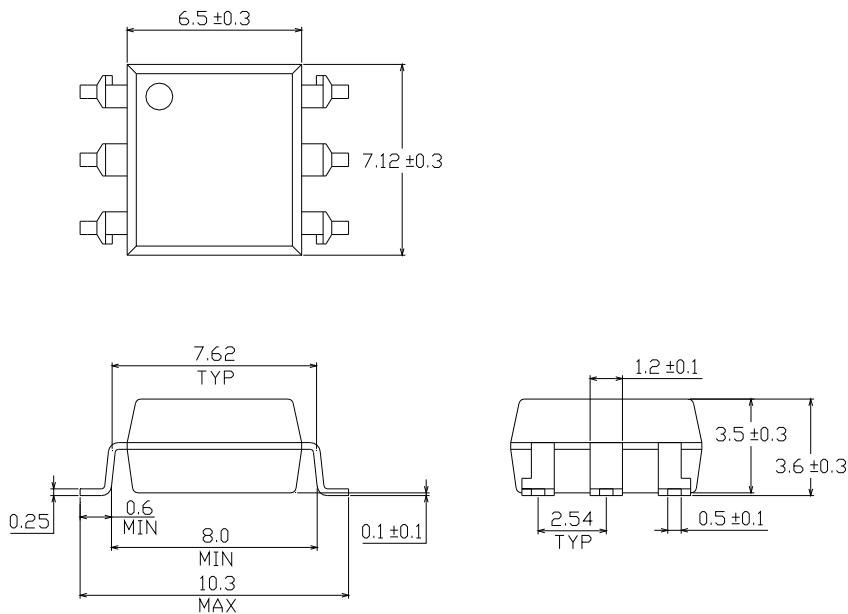



LIGHTING FOREVER

6 PIN DIP PHOTOTRANSISTOR AC INPUT PHOTOCOUPLER

H11AAX Series

Recommended pad layout for surface mount leadform

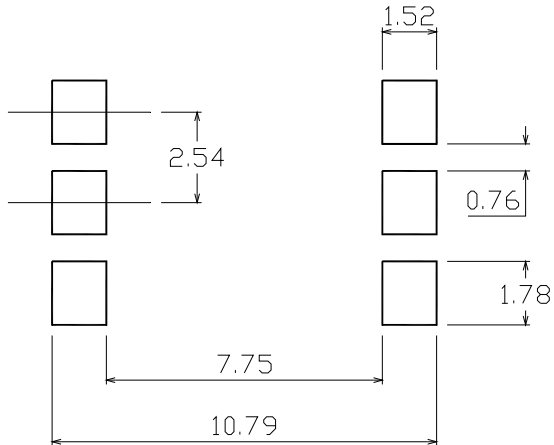

Device Marking

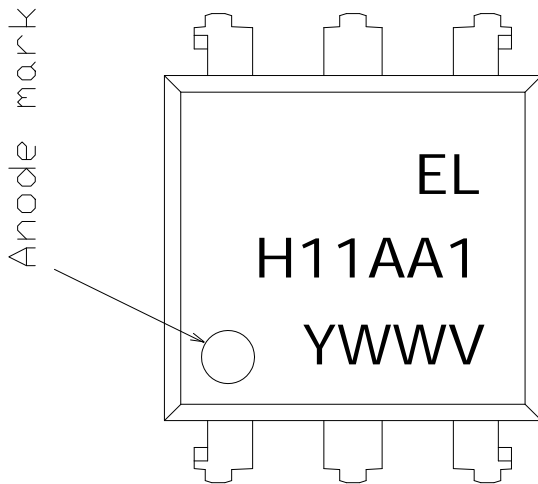

Notes

- EL denotes Everlight
- H11AA1 denotes Part Number
- Y denotes 1 digit Year code
- WW denotes 2 digit Week code
- V denotes VED safety (optional)

6 PIN DIP PHOTOTRANSISTOR AC INPUT PHOTOCOUPLER

H11AAX Series

Tape & Reel Packing Specifications

Option TA

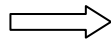
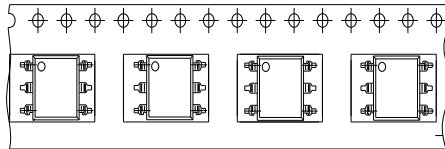

Direction of feed from reel

Option TB

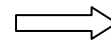
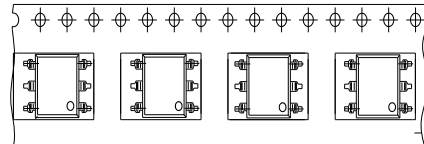

Direction of feed from reel

Tape dimensions

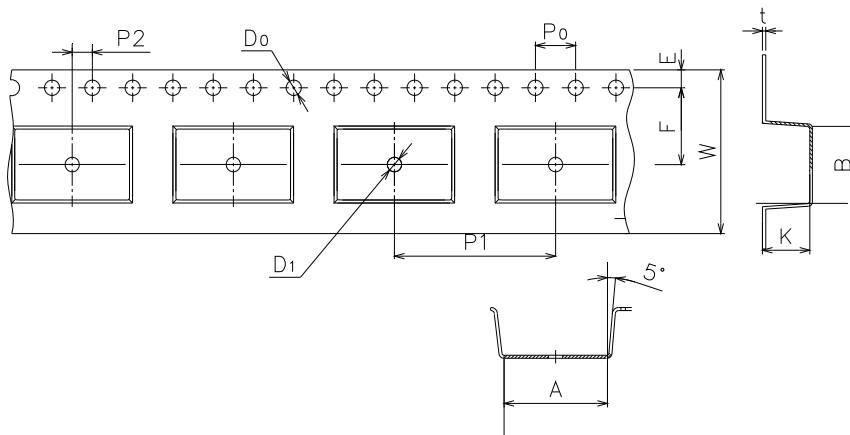

Dimension No.	A	B	Do	D1	E	F
Dimension (mm)	10.4±0.1	7.52±0.1	1.5±0.1	1.5+0.1/-0	1.75±0.1	7.5±0.1

Dimension No.	Po	P1	P2	t	W	K
Dimension (mm)	4.0±0.15	16.0±0.1	2.0±0.1	0.35±0.03	16.0±0.2	4.5±0.1



LIGHTING FOREVER

6 PIN DIP PHOTOTRANSISTOR AC INPUT PHOTOCOUPLER

H11AAX Series

Solder Reflow Temperature Profile

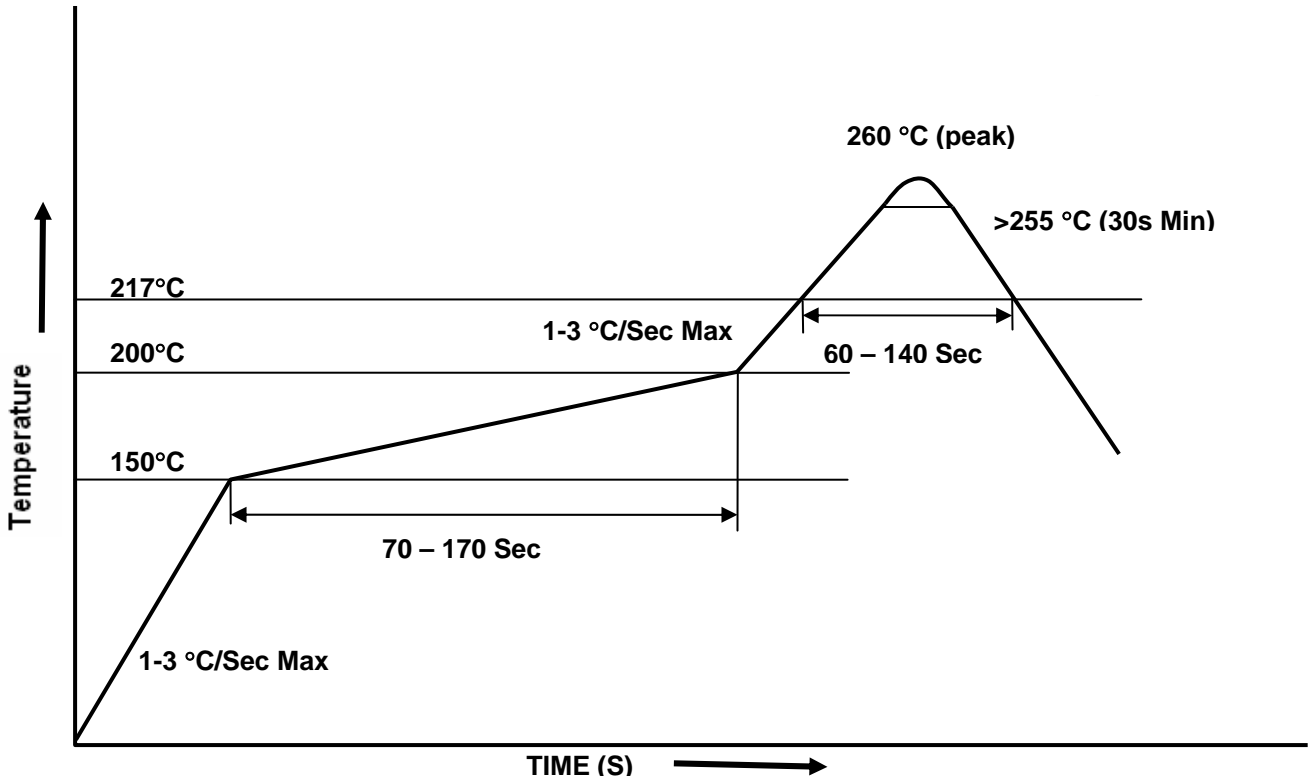



6 PIN DIP PHOTOTRANSISTOR AC INPUT PHOTOCOUPLER

H11AAX Series

DISCLAIMER

1. Above specification may be changed without notice. EVERLIGHT will reserve authority on material change for above specification.
2. When using this product, please observe the absolute maximum ratings and the instructions for use outlined in these specification sheets. EVERLIGHT assumes no responsibility for any damage resulting from use of the product which does not comply with the absolute maximum ratings and the instructions included in these specification sheets.

These specification sheets include materials protected under copyright of EVERLIGHT. Reproduction in any form is prohibited without the specific consent of EVERLIGHT.