

APPROVAL

PART NO.	DESCRIPTION	REMARKS
HT2203L	LCD MODULE (240 x RGB x 320 Dots)	This is ROHS compliant

CUSTOMER APPLICATION P/N	
APPROVED BY	
DATE	

PLEASE KINDLY FIND AND APPROVE THE SPECIFICATIONS INSERTED
HEREIN AND RETURN ONE COPY HERE OF WITH YOUR SIGNATURE OF APPROVAL.

PERPARED BY	CHECKED BY	CONFIRMED BY



HYES Optoelectronics, Inc.

2000 Wyatt Drive Suite 6
Santa Clara, CA 95054 USA

REVISION HISTORY

Date	Rev. No.	Page	Summary
Feb. 19, 2008	-	ALL	- 1'st Issue

CONTENTS

- 1. Basic Specifications**
 - 1.1 Display Specifications**
 - 1.2 Mechanical Specifications**
 - 1.3 Outline Dimension**
 - 1.4 Voltage Generation Circuit**
 - 1.5 Schematic**
- 2. Electrical Characteristics**
 - 2.1 Absolute Maximum Ratings**
 - 2.2 Environmental Conditions**
 - 2.3 DC Characteristics**
- 3. Optical Characteristics**
- 4. Interface Pins**
- 5. Backlight Specifications (LED Unit)**
- 6. Recommended Software Setting Values (Initial code)**
- 7. Power Supply Sequence**
- 8. Read/Write Timing characteristics (80 series MPU)**
- 9. LCD Module Out-Going Quality Level**
- 10. The Caution and Handling**

Date : Feb. 19, 2008

TECHNICAL SPECIFICATION

HYES

LCM

HT2203L

Page 3 of 24

1. Basic Specifications

1.1 Display Specifications

Item	Description	Note
Resolution	240 × RGB × 320	
Display mode	TFT, Normally White, Transmissive	262K Color
Viewing direction	6 O'clock	
Driving method	720Ch-Source, 320Ch-Gate	
Backlighting	LED, White (4 chips in Parallell)	
Diver IC	ILI9320, COG	
Others	16-Bit, 80 Series	

1.2 Mechanical Specifications

Item	Specification	Unit
Module Size (W × H × T)	39.08 × 54.22 × 2.6	mm
Viewing Area (W × H)	-	mm
Active Area (W × H)	33.48 × 44.64	mm
Dot Size (W × H)	-	mm
Dot Pitch (W × H)	0.051 × 0.153	mm
Weight	About 10	g

1.3 Outline Dimension

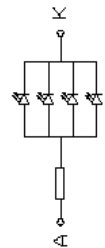
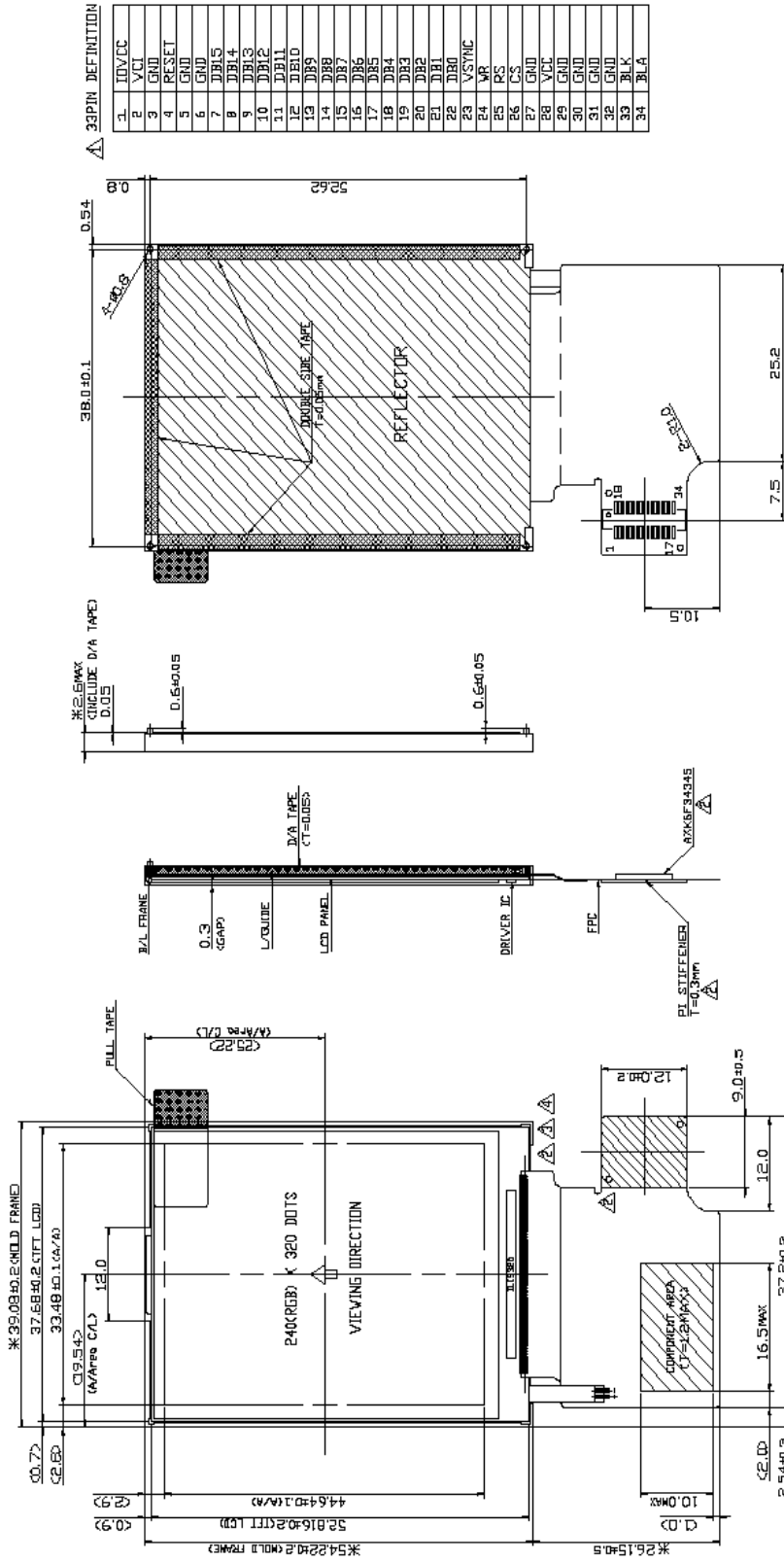

CIRCUIT DIAGRAM

- NOTES:
- 1.DISPLAY TYPE: 262K TRANSMISSIVE
 - 1.GENERAL TOLERANCE ±0.2
 - 2.BACKLIGHT LED USED 4CHIP

Date : Feb. 19, 2008

TECHNICAL SPECIFICATION



LCM

HT2203L

Page 5 of 24

1.4 Block Diagram

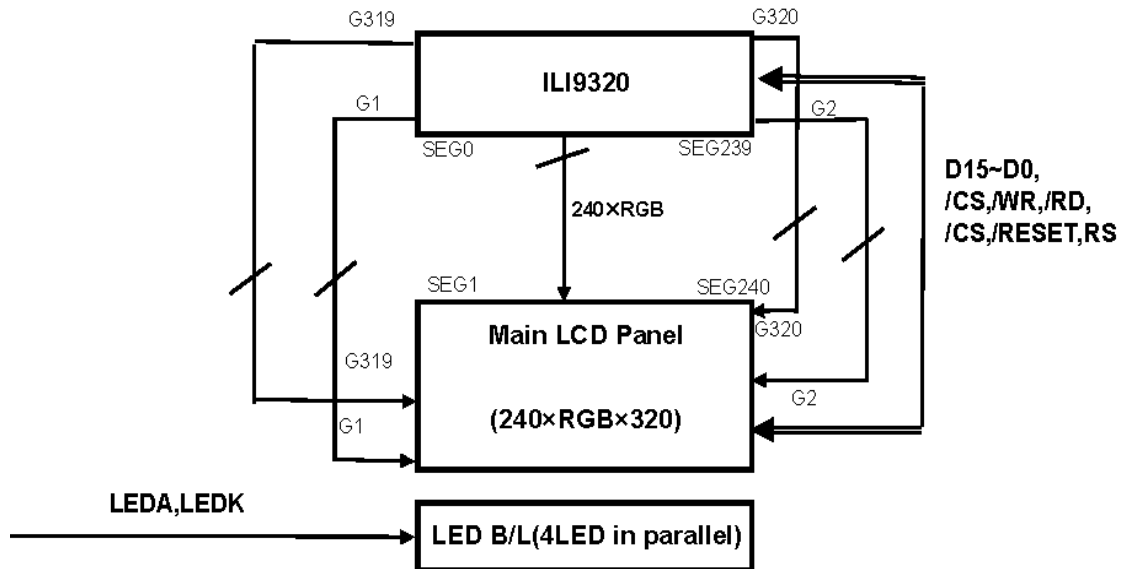

Date : Feb. 19, 2008

TECHNICAL SPECIFICATION

HYES

LCM

HT2203L

Page 6 of 24

1.5 Schematic

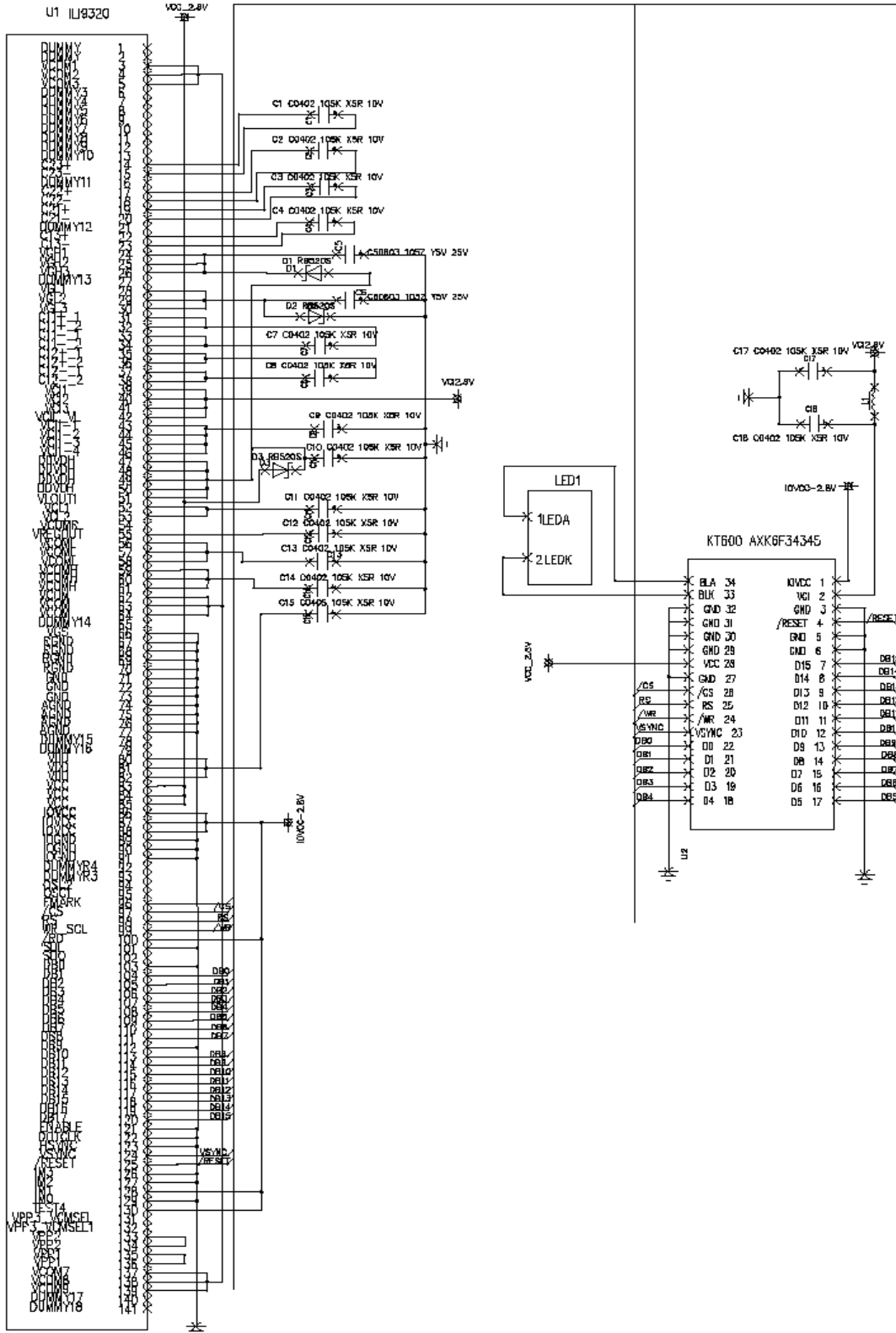

Date : Feb. 19, 2008

TECHNICAL SPECIFICATION

HYES

LCM

HT2203L

Page 7 of 24

2. Electrical Characteristics

2.1 Absolute Maximum Ratings

Item	Symbol	Value			Unit	Condition	Remark	
		Min.	Typ.	Max				
Supply Voltage Range	Logic	V _{CC}	-0.3	-	4.6	V	Ta =25℃	
	LCD	V _{GH}	-0.3	-	18.5	V	Ta =25℃	VRP-VRN
		V _{GL}	-0.3	-	-18.5	V	Ta =26℃	
Input Voltage	V _{IN}	-0.3	-	V _{CC} + 0.3	V	Ta =25℃		

2-2 Environmental Conditions

Item	Symbol	Min.	Max.	Unit
Operating temperature	Topr	-20	70	℃
Storage temperature	Tstg	-30	80	℃
Humidity (Ambient temperature=Ta)	Ta ≤ 60℃		90% RH max.	

2-3 DC Characteristics

Items	Sysbol	Spec. Value			Unit	Condition	
		Min.	Typ.	Max.			
Operating voltage	Logic	V _{CC}	-	2.8	-	V	
	GATE	V _{GH}	12	-	18	V	
		V _{GL}	- 11	-	- 7	V	
Supply current	ICC	-	-	15.0	mA		
Input voltage	High level	V _{IH}	0.8 × IOV _{CC}	-	IOV _{CC}	V	-
	Low level	V _{IL}	-0.3	-	0.2 × V _{CC}	V	-

Date : Feb. 19, 2008

TECHNICAL SPECIFICATION

HYES

LCM

HT2203L

Page 8 of 24

3. Optical Characteristics

Transmissive mode

(Ta = 25°C)

Item	Symbol		Min.	Typ.	Max.	Unit	Condition	Note
Viewing	θ2-θ1	∅=0 (Y1-Y2)	50	60	-	Deg	Cr > 10	
		∅=90 (X1-X2)	80	90	-			
Contrast ratio	Cr		150	250	-	-	θ = 0 ∅ = 0	
Response Time	Tr + Tf		-	25	-	ms	θ = 0 ∅ = 0	
CIE Coordi- -nate	R	(x,y)	0.58, 0.30	0.63, 0.34	0.68, 0.40		θ = 0 ∅ = 0	
	G	(x,y)	0.29, 0.55	0.33, 0.60	0.38, 0.65			
	B	(x,y)	0.09, 0.03	0.14, 0.08	0.19, 0.13			
	W	(x,y)	0.23, 0.25	0.28, 0.30	0.33, 0.35			
Brightness	L		150	220	-	cd/m ²	18mA/LED	
Uniformity			50	75	-			

* ∅ = 0°, ∅ = 90° means viewing direction.

* B/L is turned on.

* Remark : as for contrast ratio, it is measured in panel only.

Date : Feb. 19, 2008

TECHNICAL SPECIFICATION

HYES

LCM

HT2203L

Page 9 of 24

Note 1 . Definition of angle Θ and Φ

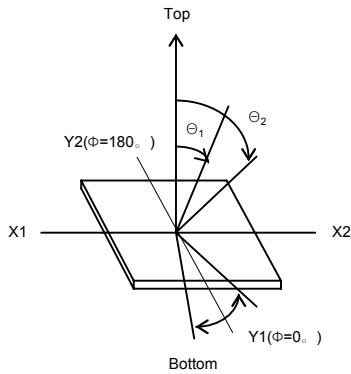

Note 2. Definition of viewing angle Θ_1 and Θ_2

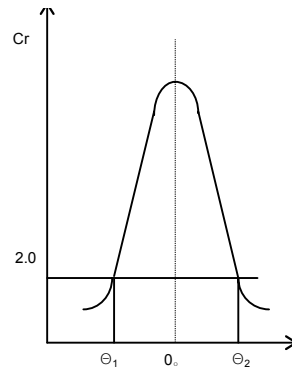

Note 3. Definition of contrast Cr

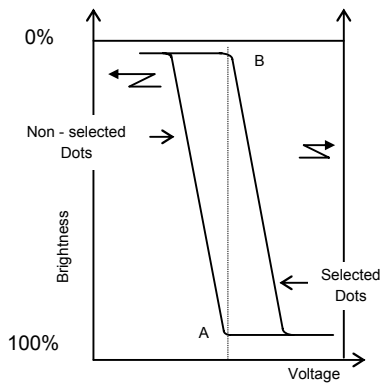

$$Cr = (A/B)^P$$

Negative : P = -1 Set
Positive : P = +1 Point

Lens $\varnothing = 3\text{mm}$

Note 4. Definition of Optical response

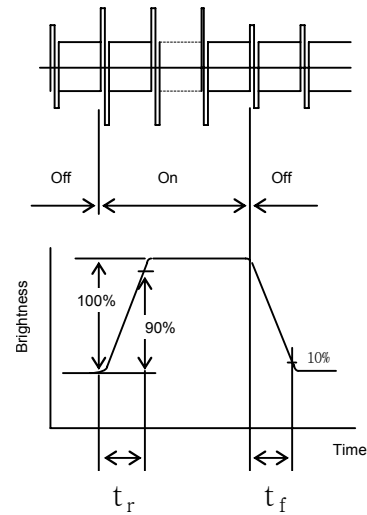

Note 5. Measuring Point(9 POINTS) (WxH)

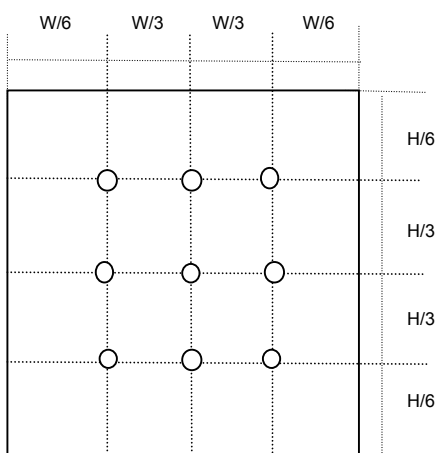

Rating is defined as the average brightness inside the viewing area

Date : Feb. 19, 2008

TECHNICAL SPECIFICATION

HYES

LCM

HT2203L

Page 10 of 24

4. Interface Pins

no	symbol	Description
1	IOVCC	IOVCC(1.8V/2.8V)
2	VCI	VCI(2.8V)
3	GND	GND
4	RESET	/Reset signal
5	GND	GND
6	GND	GND
7	DB15	Data Bit15
8	DB14	Data Bit14
9	DB13	Data Bit13
10	DB12	Data Bit12
11	DB11	Data Bit11
12	DB10	Data Bit10
13	DB9	Data Bit9
14	DB8	Data Bit8
15	DB7	Data Bit7
16	DB6	Data Bit6
17	DB5	Data Bit5
18	DB4	Data Bit4
19	DB3	Data Bit3
20	DB2	Data Bit2
21	DB1	Data Bit1
22	DB0	Data Bit0
23	VSYNC	Frame Synchronous Signal
24	WR	Write Enable Signal
25	RS	Data/Command Signal
26	/CS	Chip Select Signal
27	GND	GND
28	VCC	VCC(2.8V)
29	GND	GND
30	GND	GND
31	GND	GND
32	GND	GND
33	LEDA	LED Anode
34	LEDK	LED Cathode

Date : Feb. 19, 2008

TECHNICAL SPECIFICATION

HYES

LCM

HT2203L

Page 11 of 24

5. Backlight Specification (LED Unit)

Item	Symbol	Spec. Value			Unit	Condition
		Min.	Typ.	Max.		
Real Current	I_{LED}	-	18	-	mA	note 1.
Power dissipation	P_D	-	-	254	mW	note 2.
Operation temp.	T_{opr}	- 20 ~ 70			°C	-
Storage temp.	T_{str}	- 30 ~ 80			°C	-

Note 1. B/L: 4EA LED in pARALLEL, the Maximum current is 20mA(full brightness)

Note2. Total power consumption(max) depends on LED current/ LED driver efficiency, etc.

The above data only describes maximum power consumption of LCD's Chips.

(LED Max. $V_f=3.4V$, LED Max. Current=20mA)

6. Recommended Software Setting Values (Initial code)

LDI :ILI9320

Initial Sequence				
Condition: VCC= 2.8V, 2007.09.04				
Step	Reg	Data	Delay	Command
1		RESET	30ms	
2	HE5	8000		
3	H00	0001		START OSC
4	H01	0100	40ms	SS=1,SM=0
5	H03	1030		BGR=1,I/D=11,AM=0,TRI=0,DFM=0
6	H04	0000		RCV=00,RCH=00,RSZ=00
7	H08	0202		FP=0010,BP=0010
8	H09	0000		PTS=000,PTG=00,ISC=0000
9	H0A	0000		FMARKOE=0,FMI=000
10	H0C	0000		ENC=000,RM=1,DM=00,RIM=00
11	H0D	0000		FMP=000000000
12	H0F	0001	40ms	VSLP=0,HSLP=0,DPL=0,EPL=0
13	H10	17B0		SAP=1,BT=0111,APE=1,AP=011
14	H11	0007		DC1=000,DC0=000,VC=111
15	H12	0119		VCMR=1,PON=1,VRH=1001
16	H13	1900		VDV=11001
17	H29	000C	30ms	VCM=01100
18	H30	0000		KP1=000,KP0=000
19	H31	0505		KP3=101,KP2=101
20	H32	0004		KP5=000,KP4=100
21	H35	0006		RP1=000,RP0=110
22	H36	0707		VRP1=00111,VRP0=00111
23	H37	0105		KN1=001,KN0=101
24	H38	0002		KN3=000,KN2=010
25	H39	0707		KN5=111,KN4=111
26	H3C	0704		RN1=111,RN0=100
27	H3D	0807		VRN1=01000,VRN0=00111
28	H50	0000		HAS=00000000
29	H51	00EF		HEA=11101111
30	H52	0000		VSA=00000000
31	H53	013F		VEA=100111111
32	H60	2700		GS=0,NL=100111,SCN=000000
33	H61	0001		NDL=0,VLE=0,REV=1
34	H6A	0000	20ms	VL8=000000000
35	H90	0010		DIVI=00,RTNI=10000
36	H92	0000		NOWI=000
37	H93	0003		MCPI=011
38	H95	0110		DIVE=01,RTNE=010000
39	H97	0000		NOWE=0000
40	H98	0000		MCPE=000
41	H07	0173		BASEE=1,GON=1,DTE=1,CL=0,D1=D0=1
42				
43				

NOTE: HYES requires the customer to follow the above instructions strictly. If customer would like to change the above instructions, the customer should inform HYES and get re-check from HYES, or the customer will be responsible for any unexpected result because of the change.

Date : Feb. 19, 2008

TECHNICAL SPECIFICATION

HYES

LCM

HT2203L

Page 13 of 24

7. Power Supply Sequence

7.1 Power Supply On Sequence

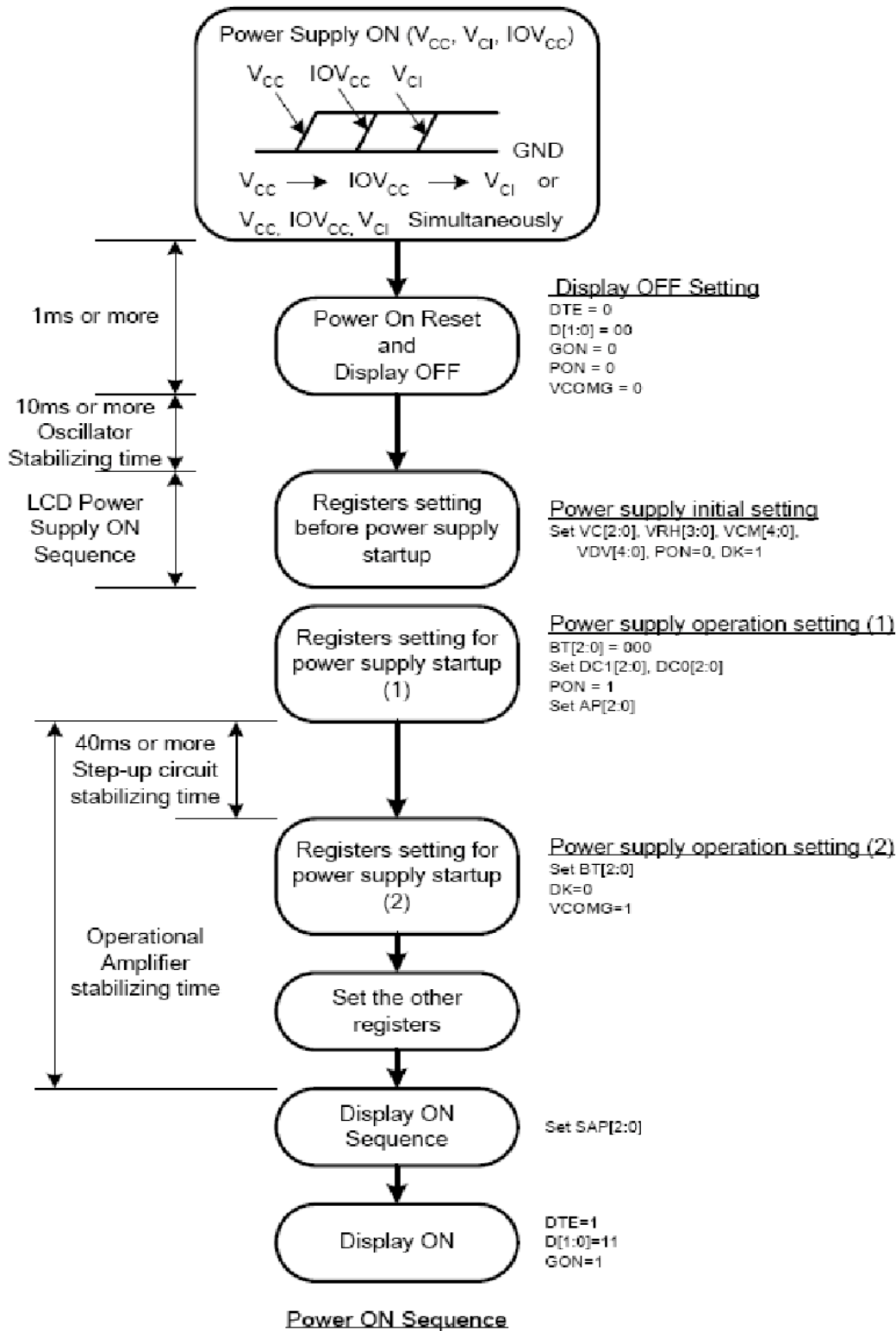

Date : Feb. 19, 2008

TECHNICAL SPECIFICATION

HYES

LCM

HT2203L

Page 14 of 24

7.2 Off Sequence

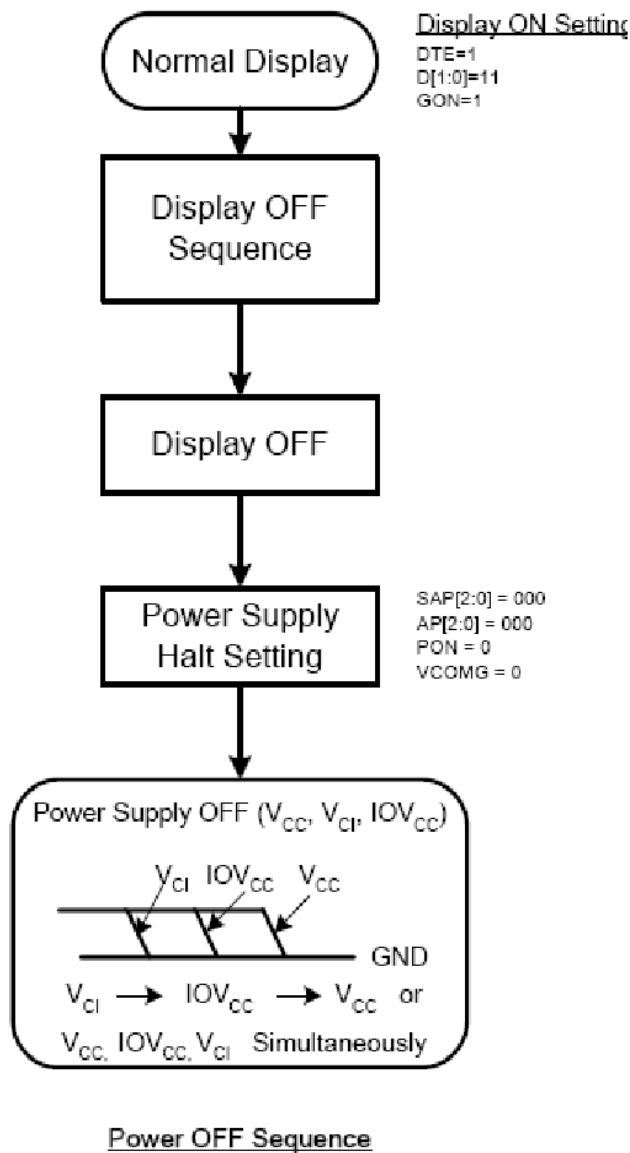

Date : Feb. 19, 2008

TECHNICAL SPECIFICATION

HYES

LCM

HT2203L

Page 15 of 24

8. Read/Write Timing characteristics (80 series MPU)

Read/Write Timing characteristics

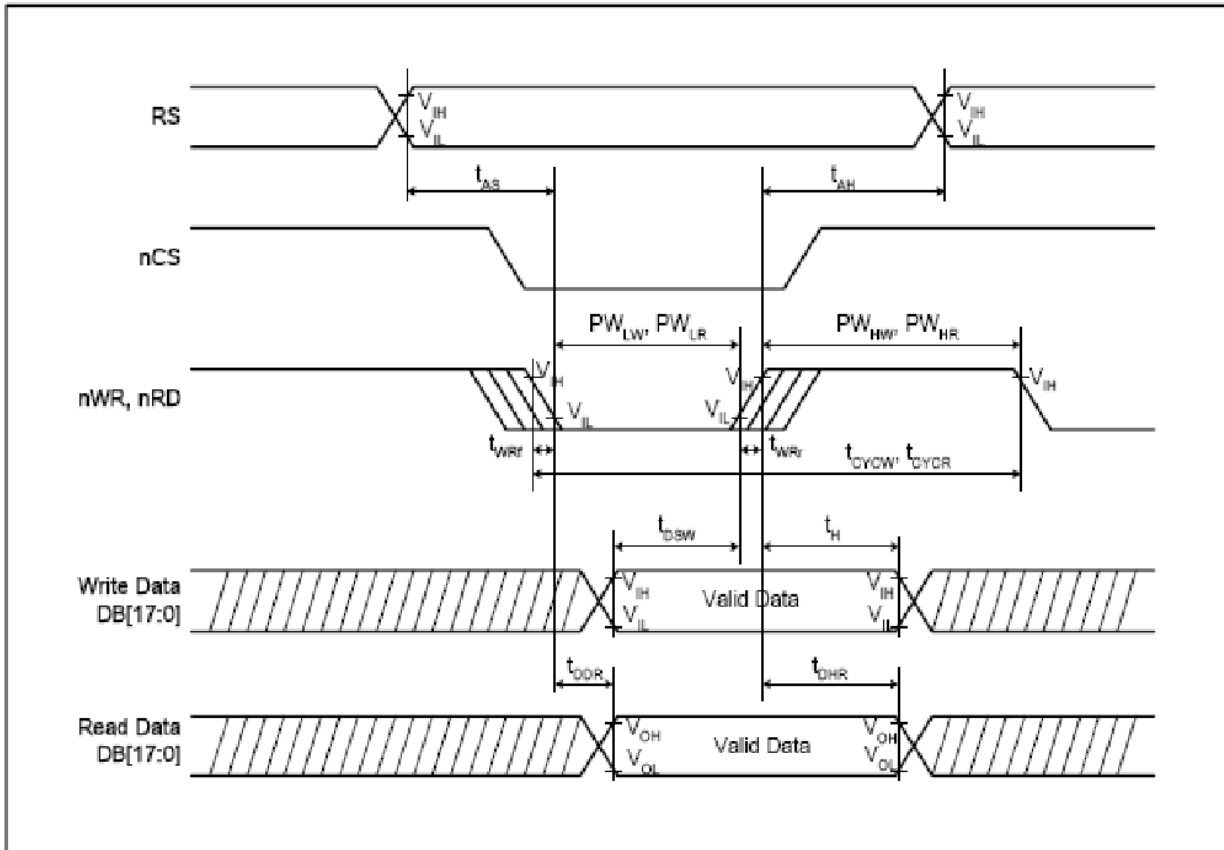

Normal Write Mode (IOVCC = 1.65~3.3V, VCC=2.4~3.3V)

Item	Symbol	Unit	Min.	Typ.	Max.	Test Condition
Bus cycle time	Write	t_{CYCW}	ns	100	-	-
	Read	t_{CYCR}	ns	300	-	-
Write low-level pulse width	PW_{LW}	ns	50	-	500	-
Write high-level pulse width	PW_{HW}	ns	50	-	-	-
Read low-level pulse width	PW_{LR}	ns	150	-	-	-
Read high-level pulse width	PW_{HR}	ns	150	-	-	-
Write / Read rise / fall time	t_{WRW}/t_{WRr}	ns	-	-	25	-
Setup time	Write (RS to nCS, E/nWR)	t_{AS}	ns	10	-	-
	Read (RS to nCS, RW/nRD)			5	-	-
Address hold time	t_{AH}	ns	5	-	-	-
Write data set up time	t_{DSW}	ns	10	-	-	-
Write data hold time	t_H	ns	15	-	-	-
Read data delay time	t_{DDR}	ns	-	-	100	-
Read data hold time	t_{DHR}	ns	5	-	-	-

Date : Feb. 19, 2008

TECHNICAL SPECIFICATION

HYES

LCM

HT2203L

Page 16 of 24

Reset Timing characteristics

Reset Operation

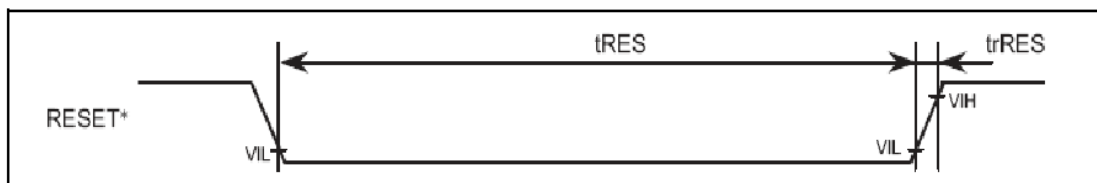

Item	Symbol	Unit	Timing diagram	Min	Typ	Max
Reset low-level width	t_{RES}	ms	Figure 91	1	—	—
Reset rise time	t_{rRES}	μ s	Figure 91	—	—	10

9. LCD Module Out-Going Quality Level

(1.0) Purpose

The LCD specification provides outgoing provision and its expected quality level based on our outgoing inspection of LCD.

(2.0) Applicable Scope

The LCD specification is applicable to the arrangement in regard to outgoing inspection and quality assurance after it.

(3.0) Quality Specification

(3.1) Quality Level

The quality level of HYES are based on GB/T2828.1, Apply Level II, normal inspection by single sampling.

Rank	Item	AQL	Note
Major(MA)	Segment Short, Missing	0.4	
	Solder Bridging, Cold Solder		
	Outside Dimension		
Minor (MI)	Black Spots, White Spots, Foreign Substance, Pinhole, Segment Deformation, Scratches(Glass & Pol.) Air Bubbles between Glass & Polarizer, Color Variation, Solder Ball, Misalignment	1.0	

Note) AQL- Acceptable Quality Level

(3.2) Appearance Standards

1) Inspection Conditions

The LCD shall be inspected under 20W white fluorescent lamp light.

The distance between the eyes and the sample shall be 30cm.

All directions for inspecting the sample should be within 30° to perpendicular line.

2) Definition of the Area

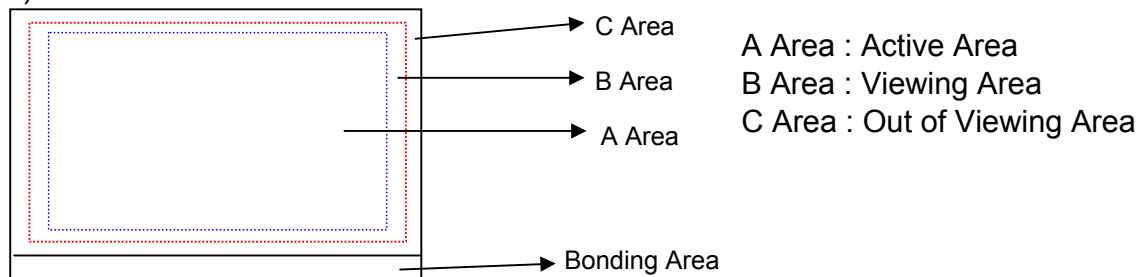

Date : Feb. 19, 2008

TECHNICAL SPECIFICATION

HYES

LCM

HT2203L

Page 18 of 24

(3.3) Appearance Spec

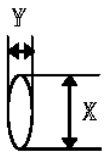
No	Item	Criteria	Rank	Remark																																													
1	Segment Short Segment Missing	Not allowed	MA																																														
2	Solder Bridging	Any bridging between components, except common circuit, is not allowed.	MA																																														
3	Outside Dimension	Drawing & specification must be within permissible tolerance.	MA																																														
4	Cold Solder	Cold solder is not allowed.	MA																																														
5	Black(White) Spots, Foreign Substances	<p>1) Round Type</p> <table border="1"> <thead> <tr> <th rowspan="2">Area Dimension***</th> <th colspan="2">Acceptable Q'ty</th> <th rowspan="2">Remark</th> </tr> <tr> <th>A Area</th> <th>B Area</th> </tr> </thead> <tbody> <tr> <td>≤ 0.1</td> <td colspan="2">Ignore</td> <td rowspan="5"></td> </tr> <tr> <td>≤ 0.2</td> <td>2</td> <td>Ignore</td> </tr> <tr> <td>≤ 0.3</td> <td>1</td> <td>Ignore</td> </tr> <tr> <td>0.3 <</td> <td>0</td> <td>Ignore</td> </tr> </tbody> </table> <p>2) Liner Type</p> <table border="1"> <thead> <tr> <th colspan="2">Dimension</th> <th colspan="2">Acceptable Q'ty</th> <th rowspan="2">Remark</th> </tr> <tr> <th>Length</th> <th>Width</th> <th>A Area</th> <th>B Area</th> </tr> </thead> <tbody> <tr> <td>-</td> <td>≤ 0.025</td> <td colspan="2">Ignore</td> <td rowspan="5"></td> </tr> <tr> <td>≤ 2.5</td> <td>≤ 0.05</td> <td>3</td> <td>Ignore</td> </tr> <tr> <td>≤ 1.5</td> <td>≤ 0.075</td> <td>2</td> <td>Ignore</td> </tr> <tr> <td></td> <td>0.075 <</td> <td colspan="2">Follow round type</td> </tr> </tbody> </table> <p>At (1) & (2) total defect q'ty is must not exceed 5 pieces.</p>	Area Dimension***	Acceptable Q'ty		Remark	A Area	B Area	≤ 0.1	Ignore			≤ 0.2	2	Ignore	≤ 0.3	1	Ignore	0.3 <	0	Ignore	Dimension		Acceptable Q'ty		Remark	Length	Width	A Area	B Area	-	≤ 0.025	Ignore			≤ 2.5	≤ 0.05	3	Ignore	≤ 1.5	≤ 0.075	2	Ignore		0.075 <	Follow round type		MI	 <p>*** : Mean Diameter (X + Y)/2</p>
Area Dimension***	Acceptable Q'ty			Remark																																													
	A Area	B Area																																															
≤ 0.1	Ignore																																																
≤ 0.2	2	Ignore																																															
≤ 0.3	1	Ignore																																															
0.3 <	0	Ignore																																															
Dimension		Acceptable Q'ty		Remark																																													
Length	Width	A Area	B Area																																														
-	≤ 0.025	Ignore																																															
≤ 2.5	≤ 0.05	3	Ignore																																														
≤ 1.5	≤ 0.075	2	Ignore																																														
	0.075 <	Follow round type																																															
6	OC Spot	<table border="1"> <thead> <tr> <th rowspan="2">Area Dimension***</th> <th colspan="2">Acceptable Q'ty</th> <th rowspan="2">Remark</th> </tr> <tr> <th>A Area</th> <th>B Area</th> </tr> </thead> <tbody> <tr> <td>≤ 0.2</td> <td colspan="2">Ignore</td> <td rowspan="3"></td> </tr> <tr> <td>≤ 0.8</td> <td>3</td> <td>Ignore</td> </tr> <tr> <td>≤ 1.0</td> <td>1</td> <td>Ignore</td> </tr> </tbody> </table>	Area Dimension***		Acceptable Q'ty		Remark	A Area	B Area	≤ 0.2	Ignore			≤ 0.8	3	Ignore	≤ 1.0	1	Ignore	MI																													
Area Dimension***	Acceptable Q'ty			Remark																																													
	A Area	B Area																																															
≤ 0.2	Ignore																																																
≤ 0.8	3	Ignore																																															
≤ 1.0	1	Ignore																																															
7	Air Bubbles Between Glass & Polarizer (Polarizer Defects)	<table border="1"> <thead> <tr> <th rowspan="2">Area Dimension***</th> <th colspan="2">Acceptable Q'ty</th> <th rowspan="2">Remark</th> </tr> <tr> <th>A Area</th> <th>B Area</th> </tr> </thead> <tbody> <tr> <td>≤ 0.15</td> <td colspan="2">Ignore</td> <td rowspan="5"></td> </tr> <tr> <td>≤ 0.3</td> <td>3</td> <td>Ignore</td> </tr> <tr> <td>≤ 0.5</td> <td>2</td> <td>Ignore</td> </tr> <tr> <td>≤ 0.7</td> <td>1</td> <td>Ignore</td> </tr> <tr> <td>Total</td> <td>5</td> <td>Ignore</td> </tr> </tbody> </table>	Area Dimension***	Acceptable Q'ty		Remark	A Area	B Area	≤ 0.15	Ignore			≤ 0.3	3	Ignore	≤ 0.5	2	Ignore	≤ 0.7	1	Ignore	Total	5	Ignore	MI																								
Area Dimension***	Acceptable Q'ty			Remark																																													
	A Area	B Area																																															
≤ 0.15	Ignore																																																
≤ 0.3	3	Ignore																																															
≤ 0.5	2	Ignore																																															
≤ 0.7	1	Ignore																																															
Total	5	Ignore																																															

Date : Feb. 19, 2008

TECHNICAL SPECIFICATION

HYES

LCM

HT2203L

Page 19 of 24

(3.3) Appearance Spec

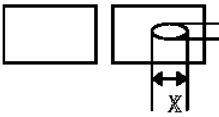
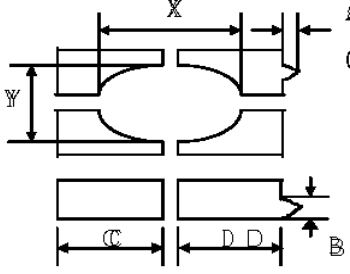
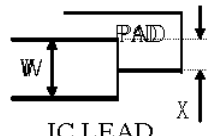
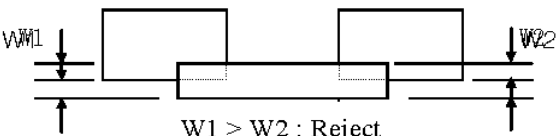
No	Item	Criteria	Rank	Remark								
8	Pin hole (On Segment)	 <p> $(X+Y)/2 \leq 0.2\text{mm}$ Within 1 per one segment (Less than 0.1mm is not counted) Total defects q'ty is must not exceed 5 pieces. </p>	MI									
9	Segment Deformation	 <p> $(X+Y)/2 \leq 0.2\text{mm}$ $A \leq 0.2\text{mm}$ $B \leq 0.2\text{mm}$ $(C-D) \leq 0.2\text{mm}$ </p> <table border="1" data-bbox="518 846 1161 987"> <thead> <tr> <th></th> <th>Acceptable Q'ty</th> </tr> </thead> <tbody> <tr> <td>Dot, Segment</td> <td>1</td> </tr> <tr> <td>LCD</td> <td>5</td> </tr> <tr> <td>≤ 0.1</td> <td>Ignore all defect</td> </tr> </tbody> </table> <p>Each visible dot must be more than half effective dot area</p>		Acceptable Q'ty	Dot, Segment	1	LCD	5	≤ 0.1	Ignore all defect	MI	$(X + Y)/2 \leq 0.2\text{mm}$
	Acceptable Q'ty											
Dot, Segment	1											
LCD	5											
≤ 0.1	Ignore all defect											
10	Color Variation	Within the three colors, except LCD Standard color is acceptable.	MI									
11	Glass & Polarizer Scratch	Follow NO.5(2) condition	MI									
12	Solder Ball	1)Acceptable if the size of void is less than 0.18mm 2)Acceptable if a solder ball is not movable 3)Rejectable if the solder ball exceed SEA in $2.54 \times 2.54\text{mm}$ area.	MI									
13	Miss Alignment	1)Acceptable if it dose not exceed 50% of the lead width IC.  <p> $X \leq W/2$: Accept $X > W/2$: Reject </p> 2)Rejectable, provided that it does exceed 50% of the component termination width.  <p> $W1 > W2$: Reject </p>										

Note : A limitation sample is given top priority

Date : Feb. 19, 2008

TECHNICAL SPECIFICATION



HYES

LCM

HT2203L

Page 20 of 24

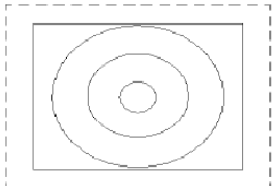
(3.3) Appearance Spec

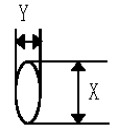
No	Item	Criteria	Rank	Remark																																																
14	Touch Panel	<p>1) Round Type、 Foreign Substances</p> <table border="1"> <thead> <tr> <th rowspan="2">Area Dimension**</th> <th colspan="2">Acceptable Q'ty</th> <th rowspan="2">Remark</th> </tr> <tr> <th>A Area</th> <th>B Area</th> </tr> </thead> <tbody> <tr> <td>≤ 0.1</td> <td colspan="2">Ignore</td> <td rowspan="4"></td> </tr> <tr> <td>≤ 0.2</td> <td>2</td> <td>Ignore</td> </tr> <tr> <td>≤ 0.3</td> <td>1</td> <td>Ignore</td> </tr> <tr> <td>0.3 <</td> <td>0</td> <td>Ignore</td> </tr> </tbody> </table> <p>2) Liner Type & Scratch</p> <table border="1"> <thead> <tr> <th colspan="2">Dimension</th> <th colspan="2">Acceptable Q'ty</th> <th rowspan="2">Remark</th> </tr> <tr> <th>Length</th> <th>Width</th> <th>A Area</th> <th>B Area</th> </tr> </thead> <tbody> <tr> <td>-</td> <td>W ≤ 0.025</td> <td colspan="2">Ignore</td> <td rowspan="6">Ignore</td> </tr> <tr> <td>L ≤ 3.0</td> <td rowspan="2">W ≤ 0.05</td> <td colspan="2">Ignore</td> </tr> <tr> <td>3.0 < L ≤ 5.0</td> <td colspan="2">2</td> </tr> <tr> <td>≤ 7</td> <td>W ≤ 0.1</td> <td colspan="2">1</td> </tr> <tr> <td>-</td> <td>W > 0.1</td> <td colspan="2">Follow round type</td> </tr> </tbody> </table> <p>4) Newton Ring</p> <p>a) Regular</p>  <p>The area of the Newton ring is more than 1/3 area of the touch panel It's NG. The area of the Newton ring is less than 1/3 area of the touch panel It's OK.</p> <p>b) None-regularity</p>  <p>The area of the Newton ring is more than 1/2 area of the touch panel It's NG. The area of the Newton ring is less than 1/2 area of the touch panel It's OK.</p>	Area Dimension**	Acceptable Q'ty		Remark	A Area	B Area	≤ 0.1	Ignore			≤ 0.2	2	Ignore	≤ 0.3	1	Ignore	0.3 <	0	Ignore	Dimension		Acceptable Q'ty		Remark	Length	Width	A Area	B Area	-	W ≤ 0.025	Ignore		Ignore	L ≤ 3.0	W ≤ 0.05	Ignore		3.0 < L ≤ 5.0	2		≤ 7	W ≤ 0.1	1		-	W > 0.1	Follow round type		MI	 <p>** : Mean Diameter (X + Y)/2</p>
Area Dimension**	Acceptable Q'ty			Remark																																																
	A Area	B Area																																																		
≤ 0.1	Ignore																																																			
≤ 0.2	2	Ignore																																																		
≤ 0.3	1	Ignore																																																		
0.3 <	0	Ignore																																																		
Dimension		Acceptable Q'ty		Remark																																																
Length	Width	A Area	B Area																																																	
-	W ≤ 0.025	Ignore		Ignore																																																
L ≤ 3.0	W ≤ 0.05	Ignore																																																		
3.0 < L ≤ 5.0		2																																																		
≤ 7	W ≤ 0.1	1																																																		
-	W > 0.1	Follow round type																																																		

(4.0) Reliability Condition

Item	Content
Room Temperature Operation	50,000 hrs

(4.1) Reliability Test - Module Middle Reliability

No.	Item	Condition	Test Time	Sample Numbers	Criteria (Acc/Rej)	Note
1	High Temp Operation	70 ± 2°C	120 hrs	3	0/1	
2	Low Temp Operation	-20 ± 2°C	120 hrs	3	0/1	
3	High Humidity Storage	60°C 90%rh	120 hrs	3	0/1	
4	Thermal Shock	30mn stage -20°C ↔70°C	100 cycles /6days	3	0/1	

(4.2) Criteria

- a. No changes for indication and appearance.
- b. Leave the all samples under room temperature 4 hours after reliability test ends.

10. LCD Module Operation Instruction

Part I. How to use the LCD Module

1. Don't hit the LCD Panel in any way because the LCD is made of glass.
2. Don't clean the surface of LCD with hard things. Please clean LCD with Air-gun or very soft cloth when necessary. The protective film on the POL can be removed just before assembly, otherwise, dust, spit or other foreign matter may attached on the LCD under the protective film. After the protective film is removed, only air-gun can be used to remove any dust or foreign matter. Fingure or cloth MUST NOT be used in such cases.
3. No chemical liquid is allowed to clean the LCD, such as alcohol, acetone and IPA. All of these candamage the LCD. Water on the LCD must be cleaned as soon as possible, for it will cause POL color change or other defect.
4. Please move and assemble LCD very carefully during assembly, and don't push or twist it.
5. Don't damage the FPC of LCD module. It will cause permanent defect.
6. Don't disassemble LCD module. It will cause permanent defect.
7. Don't expose LCD module under sunshine, strong fluorescence or ultraviolet radiation.
8. Please make sure that operators wear static-protective bands effectively and working tables are effectively earthing during operation.
9. Please place LCD module on the tray provided by HYES while moving it, in order to avoid mechanical damage. Hold the module's side frames to avoide damage during moving.
10. Don't twist, disassemble, squeeze or hit the PCB. It will damage the circuit or component on PCB and cause functional defect.
11. Please use the connector according to the instruction provided by HYES.
12. Please place dual module with the sub-panel upward. Trays should be placed in contrary direction. An empty tray should be placed on the top.
13. Sealing operation on PCB must be very careful to avoid short or cut the original circuit on PCB. Otherwise, it will cause permanant damage to the LCD.
14. Don't add direct DC or high voltage to LCD panel. It will cause functional damage to the LCD or shorten the life of LCD product.
15. LCD may respond slowly or display abnormally in extrem temperature (lower than -20°C or higher than 50°C). But this doesn't mean LCD functional defect. LCD will display normally in regular temperature. Therefore, don't use LCD product in extrem temperature.

Date : Feb. 19, 2008

TECHNICAL SPECIFICATION

HYES

LCM

HT2203L

Page 23 of 24

16. Don't push the display area of LCD panel, it will cause abnormal display. This doesn't mean LCD functional defect, neither. LCD will display normally in regular temperature.
17. Electrical test of LCD product is made by using mobile phone provided by Customer. We can use special test equipment to do the test, also.
18. The black band on IC on LCD product is used to protect the IC from light. Please do NOT remove it.
19. Please take great care to use connector. Customer should be responsible for connector defect caused by operation on Customer side.

Part II Storage

1. Physical status of liquid crystal will change in extrem temperature, and it can not be resumed when the temperature returns to be normal. So LCD module should be stored in required temperature.
2. LCD module should be stored in required humidity. Low humidity may add static, while high humidity may corrode the ITO circuit of LCD product. The suitable storage environment is: temperature: $22 \pm 5^{\circ}\text{C}$, humidity: $55\% \pm 10\%$.
3. Don't expose LCD module under sunshine, strong fluorescence or ultraviolet radiation for a long time. It should be stored in dark area.
4. LCD should be stored in static-protective polythene bag. Don't expose it in the air for a long time.

Date : Feb. 19, 2008		TECHNICAL SPECIFICATION	
	LCM	HT2203L	Page 24 of 24