

Distinctive Characteristics

Square, rectangular, and round shaped caps.

Latchdown feature gives indication of circuit status. Audible and tactile feedback with smooth and responsive operation.

Snap-action mechanism for long life.

Stainless steel frame on snap-in models has a specially designed projection, which prevents rotation and correctly orients switch in panel.

12mm body diameter.

Molded-in terminals lock out flux, dust, and other contaminants.

8mm panel thickness capability. Rear panel bushing or snap-in mounting.

Optional PCB adaptors in straight and right angle types.

Matching illuminated switches available and shown in the illuminated section.

Matching indicators available and shown at the end of Section M.

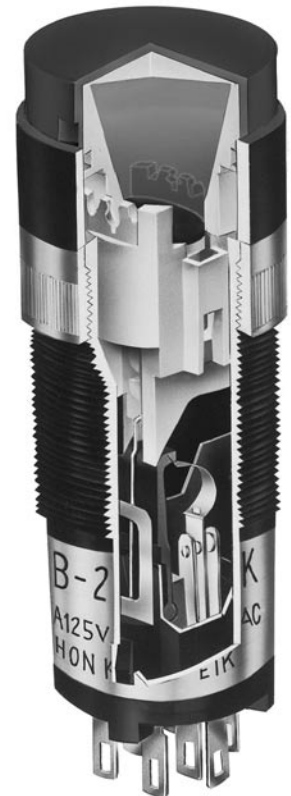

Actual Size

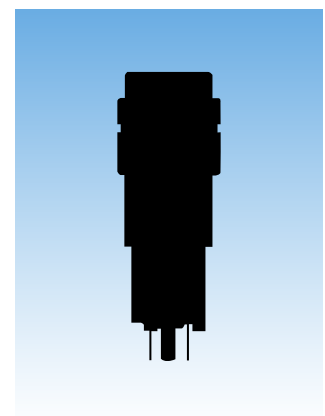

General Specifications

Electrical Capacity (Resistive Load)

Power Level (code W): 1A @ 125/250V AC or 1A @ 30V DC
Logic Level (code G): 0.4VA maximum @ 28V AC/DC maximum
 (Applicable Range 0.1mA ~ 0.1A @ 20mV ~ 28V)
 Note: Find additional explanation of operating range in Supplement section.

Other Ratings

Contact Resistance: 50 milliohms maximum
Insulation Resistance: 1,000 megohms minimum @ 500V DC
Dielectric Strength: 1,000V AC minimum between contacts & 1,500 minimum between contacts & case (silver) for 1 minute minimum;
 750V AC minimum between contacts & 1,500 minimum between contacts & case (gold) for 1 minute minimum;
Mechanical Life: 100,000 operations minimum
Electrical Life: 50,000 operations minimum for silver; 100,000 operations minimum for gold
Nominal Operating Force: Single pole 0.98 ~ 2.45N for maintained & 0.98 ~ 1.96N for momentary;
 Double pole 1.47 ~ 3.43N for maintained & 1.47 ~ 2.94N for momentary
Contact Timing: Nonshorting (break-before-make)
Travel: Pretravel .087" (2.2mm); Overtravel .031" (0.80mm); Total Travel .118" (3.0mm)

Materials & Finishes

Housing: Polyamide (UL94V-0)
Movable Contactor: Silver for power circuit; copper with gold plating for logic level circuit
Stationary Contacts: Silver for power circuit; copper with gold plating for logic level circuit
Housing Base: Polyamide (UL94V-0)
Terminal Base: Polyester
Common Terminal: Phosphor bronze with silver flash plating for power circuit;
 Phosphor bronze with gold flash plating for logic level circuit
End Terminals: Brass with silver flash plating for power circuit;
 Brass with gold flash plating for logic level circuit

Environmental Data

Operating Temp Range: -25°C through +70°C (-13°F through +158°F)
Humidity: 90 ~ 95% humidity for 96 hours @ 40°C (104°F)
Vibration: 10 ~ 55Hz with peak-to-peak amplitude of 1.5mm traversing the frequency range & returning in 1 minute; 3 right angled directions for 2 hours
Shock: 50G (490m/s²) acceleration (tested in 6 right angled directions, with 3 shocks in each direction)

Installation

Mounting Torque: 0.78Nm (6.9 lb•in) maximum
Cap Installation Force: 4.51N (1.0 lbf) maximum downward force on cap
Soldering Time & Temperature: Manual Soldering: See Profile A in Supplement section.

Standards & Certifications

Flammability Standards: UL94V-0 housing & housing base
UL & C-UL Recognized: Single & double pole models recognized at 1A @ 125/250V AC, 1A @ 30V DC, & 0.4A @ 28V DC; UL File No. WOYR2.E44145; add "/U" to end of part number to order UL mark on switch; C-UL File No. WOYR8.E44145; add "/C-UL" to end of part number to order C-UL mark on switch
CSA Certified: Single & double pole models recognized at 1A @ 125/250V AC, 1A @ 30V DC, & 0.4VA @ 28V maximum; CSA File No. 023535-0-000; add "/C" to end of part number to order CSA mark on switch.



TYPICAL SWITCH ORDERING EXAMPLE

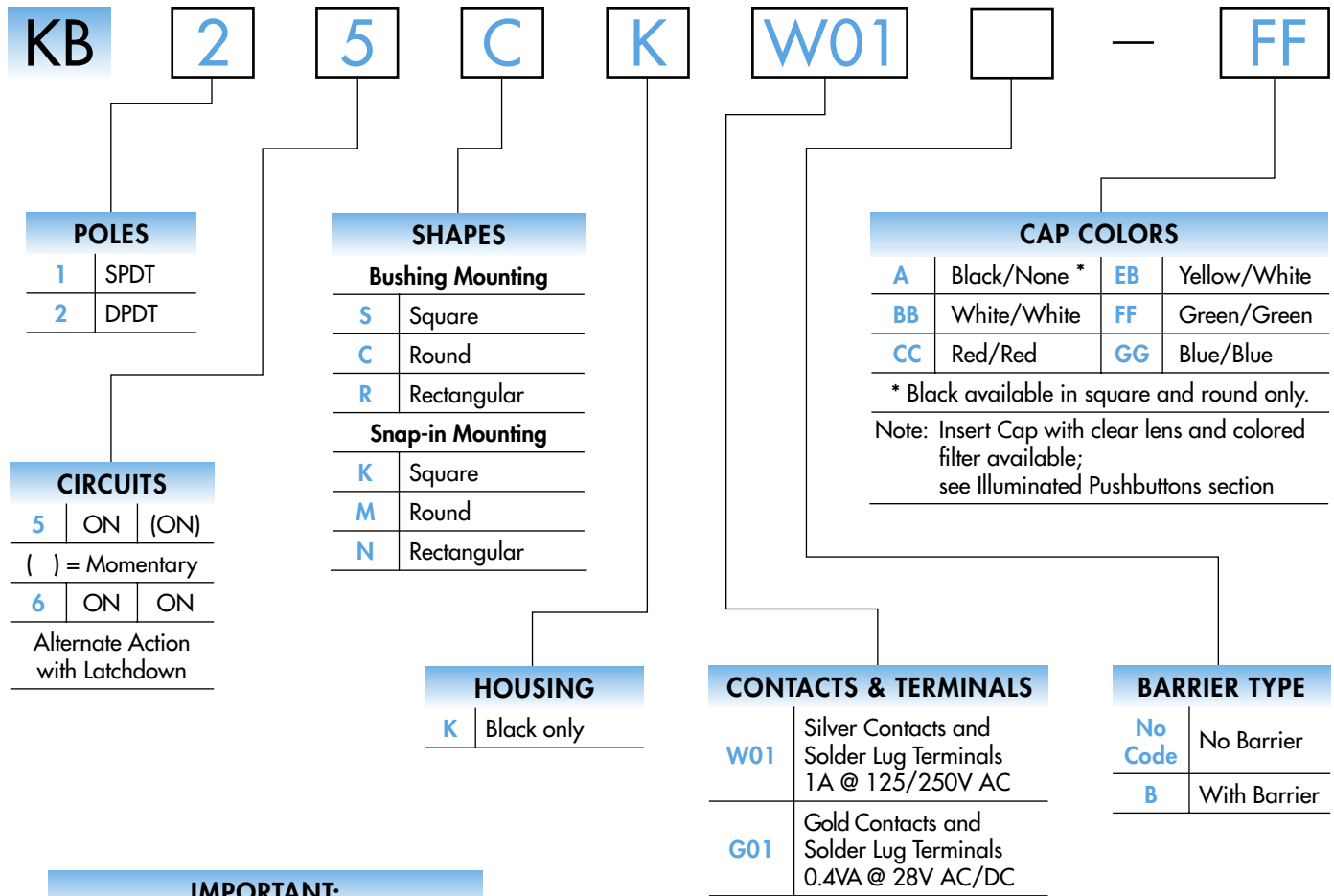

IMPORTANT:



Switches are supplied without UL, C-UL & CSA marking unless specified. Specific models & ratings noted on General Specifications page.

DESCRIPTION FOR TYPICAL ORDERING EXAMPLE

KB25CKW01-FF

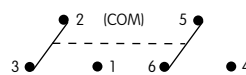

POLES & CIRCUITS

Pole	Model	Plunger Position () = Momentary		Connected Terminals		Throw & Schematics
		Normal	Down	Normal	Down	
SP	KB15 *KB16	ON ON	(ON) ON	2-3	2-1	SPDT 
DP	KB25 *KB26	ON ON	(ON) ON	2-3 5-6	2-1 5-4	DPDT 

* When in latchdown position for the alternate circuit, cap position is .055" (1.4mm) above the built-in bezel.

SHAPES & MOUNTING TYPES

Bushing Mounting



.551" (14.0mm)
Square

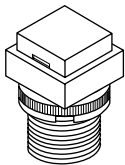

No barrier

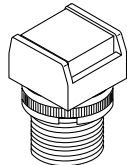

With barrier



.551" (14.0mm)
Round

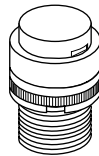

.551" x .728" (14.0mm x 18.5mm)
Rectangular

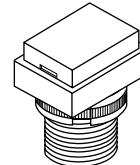

No barrier

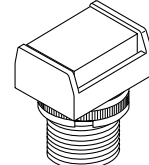

With barrier

Bezel or barrier is an integral part of the switch body. One mounting nut AT057 supplied with each switch.

Snap-in Mounting



.551" (14.0mm)
Square

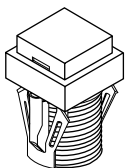

No barrier

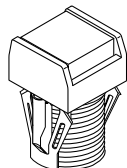

With barrier



.551" (14.0mm)
Round

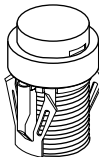

.551" x .728" (14.0mm x 18.5mm)
Rectangular

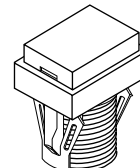

No barrier

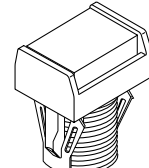

With barrier

Bezel or barrier is an integral part of the switch body.

Panel Cutouts

Bushing Mounting

Without
Keyway

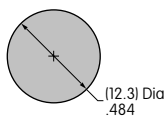

Panel Thickness:
.020" ~ .315"
(0.5 ~ 8.0mm)

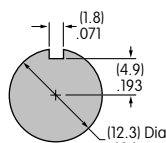

With
Keyway

Snap-in Mounting

Panel Thickness:
.039" ~ .138"
(1.0 ~ 3.5mm)

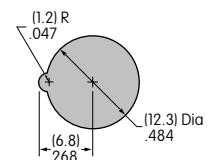

Panel thicknesses, when using optional accessories, are shown with the accessories at the end of this KB section. Socket wrench AT108 may be used for bushing mounting. Overtightening the mounting nut may damage the switch housing.

HOUSING

K Housing available in black only. Bezel or barrier is an integral part of the switch body.

CONTACT MATERIALS, RATINGS & TERMINALS

W Silver Contacts **Power Level**
1A @ 125V AC & 250V AC

01 Solder Lug

G Gold Contacts **Logic Level**
0.4VA maximum @ 28V AC/DC

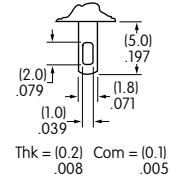

Complete explanation of operating range in Supplement section.

AT055 Crossover Guard

A partitioned plastic guard is supplied with each switch to provide insulation between terminals.

Installation steps:

1. Identify wire-to-terminal connections.
2. Thread wires through the guard.
3. Solder the connections.
4. Push the guard fully onto the switch body.

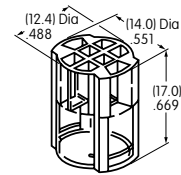

Material: Polypropylene

BARRIER TYPE

No Code No Barrier
Built-in bezel

B With Barrier
Built-in barrier only available for square and rectangular

CAPS & CAP COLORS

Colors Available:

- A** Black (Not available in Rectangular)
- BB** White/White
- CC** Red/Red
- EB** Yellow/White
- FF** Green/Green
- GG** Blue/Blue

AT485
Square

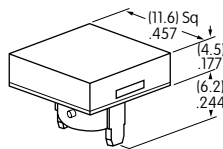

AT486
Round

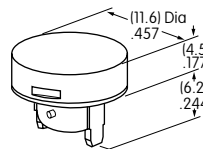

AT4021
Rectangular

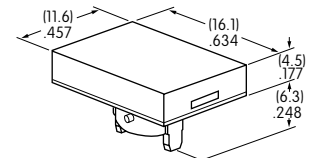

Material: Polycarbonate Finish: Glossy

TYPICAL SWITCH DIMENSIONS

Square • Bushing Mount

Single & Double Pole

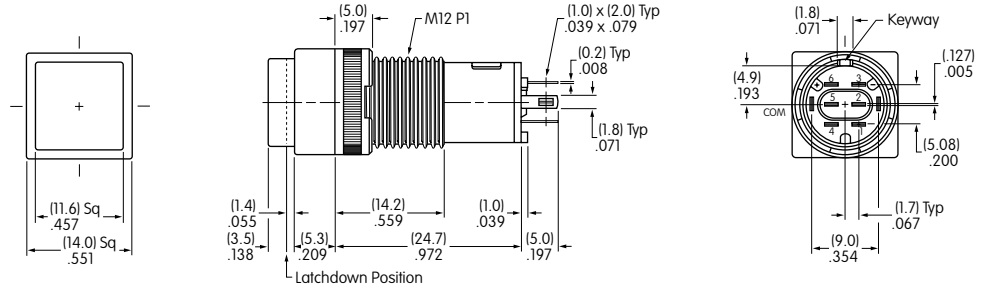

KB15SKW01-GG

Single pole models do not have terminals 4, 5, & 6.

Round • Bushing Mount

Single & Double Pole

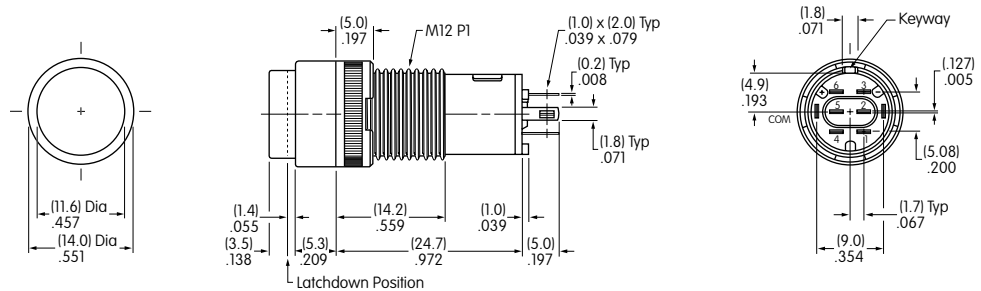

KB25CKW01-GG

Single pole models do not have terminals 4, 5, & 6.

Rectangular • Bushing Mount

Single & Double Pole

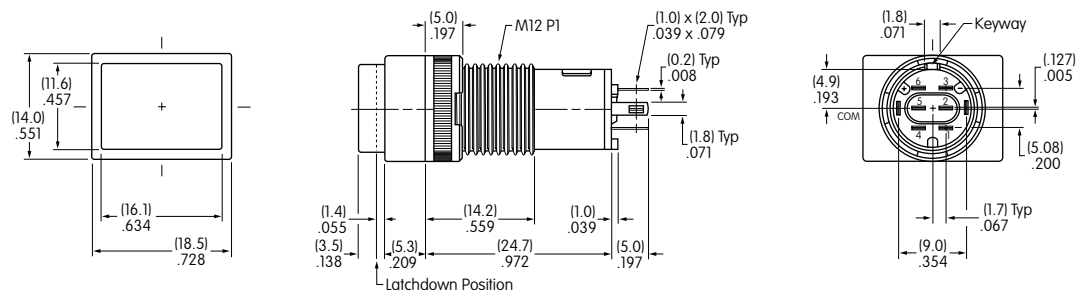

KB15RKW01-GG

Single pole models do not have terminals 4, 5, & 6.

TYPICAL SWITCH DIMENSIONS

Square • Snap-in Mount

Single & Double Pole

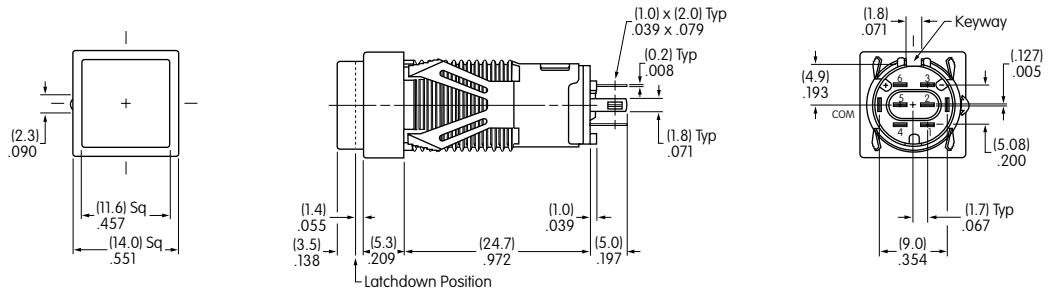

KB16KKW01-CC

Single pole models do not have terminals 4, 5, & 6.

Round • Snap-in Mount

Single & Double Pole

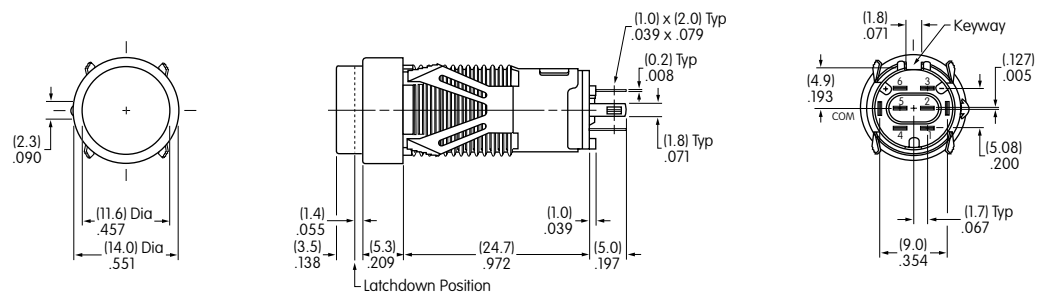

KB26MKW01-CC

Single pole models do not have terminals 4, 5, & 6.

Rectangular • Snap-in Mount

Single & Double Pole

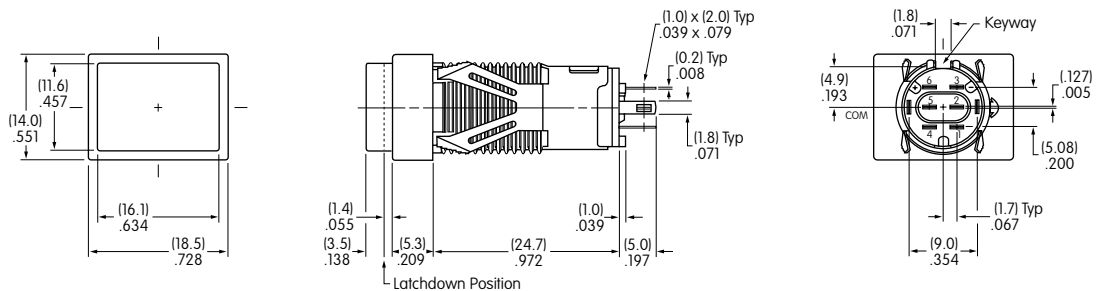

KB16NKW01-CC

Single pole models do not have terminals 4, 5, & 6.

TYPICAL SWITCH DIMENSIONS

Square • Barrier • Bushing Mount

Single & Double Pole

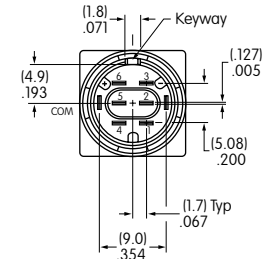
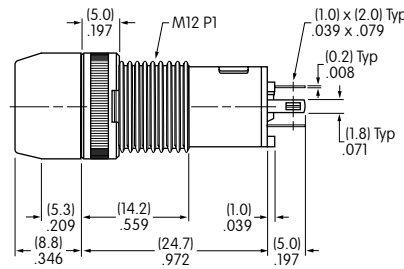
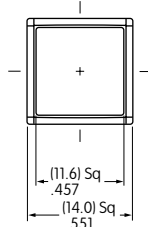

KB15KW01B-BB

Single pole models do not have terminals 4, 5, & 6.

Square • Barrier • Snap-in Mount

Single & Double Pole

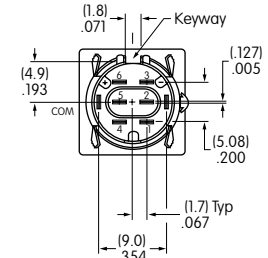
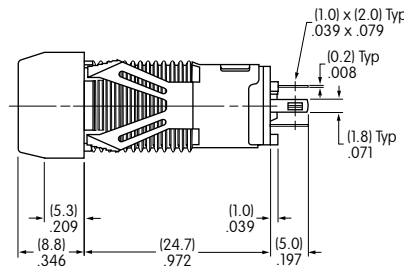
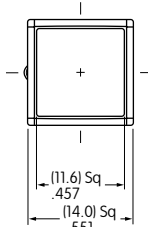

KB15KKW01B-CC

Single pole models do not have terminals 4, 5, & 6.

Rectangular • Barrier • Bushing Mount

Single & Double Pole

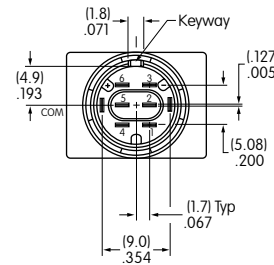
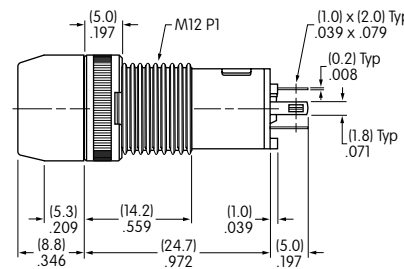
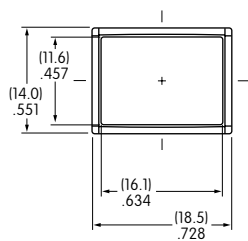

KB15RKW01B-FF

Single pole models do not have terminals 4, 5, & 6.

Rectangular • Barrier • Snap-in Mount

Single & Double Pole

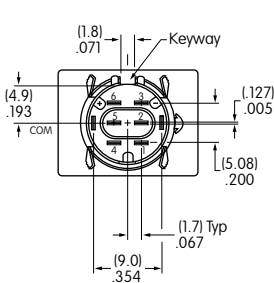
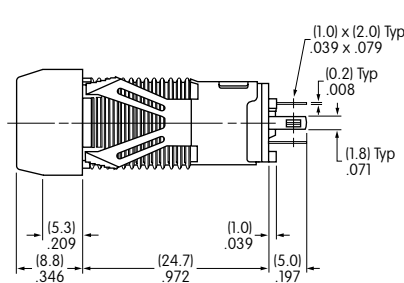
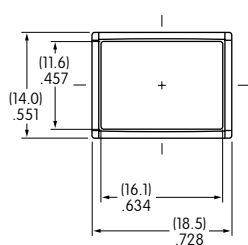

KB15NKW01B-GG

Single pole models do not have terminals 4, 5, & 6.

OPTIONAL ACCESSORIES

PCB Adaptors

AT701
Single Pole
Straight PC
Terminals



AT702
Double Pole
Straight PC
Terminals



AT077
Single Pole
Right Angle PC
Terminals

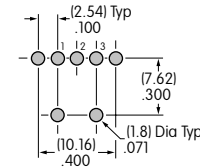
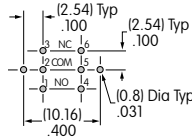
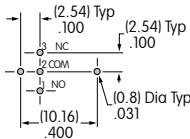
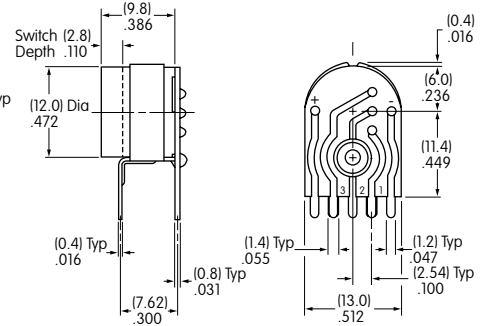
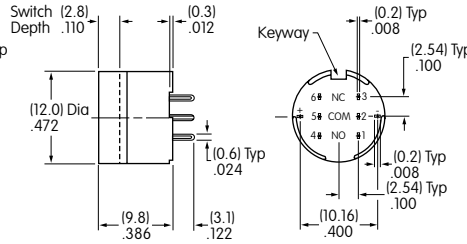
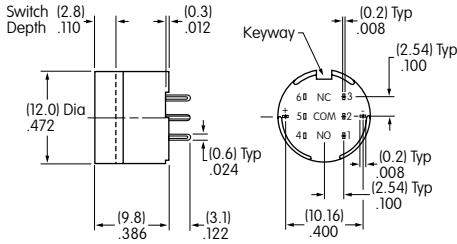

Material: Glass fiber reinforced polyamide

Note: Order adaptors separately.

Dust Covers

Panel Thickness Range: .020" ~ .268" (0.5 ~ 6.8mm) for Bushing Mounting; .020" ~ .079" (0.5 ~ 2.0mm) for Snap-in Mounting.
Dust Covers reduce the depth of switch behind panel by .047" (1.2mm).

AT495
For Square & Round
(not for Barrier type)

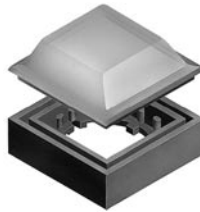

AT4025
For Rectangular
(not for Barrier type)

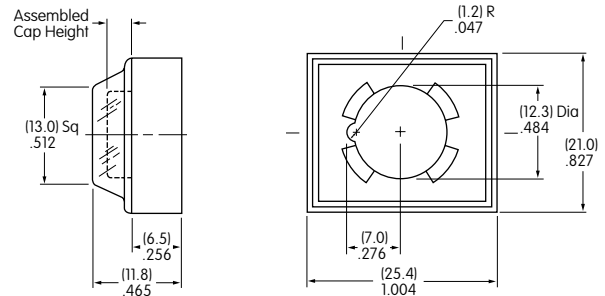
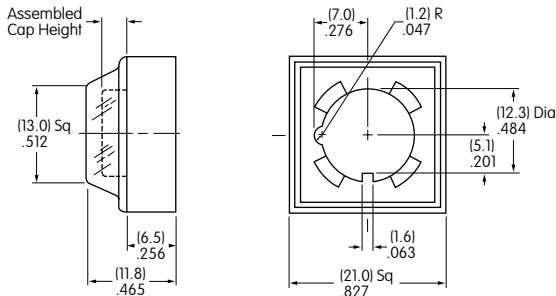

Material: Lid: PVC PVC loses pliability below 0°C (32°F). Base: Polyamide

OPTIONAL ACCESSORIES

AT494 Protective Guard For Square & Round (not for Barrier type)

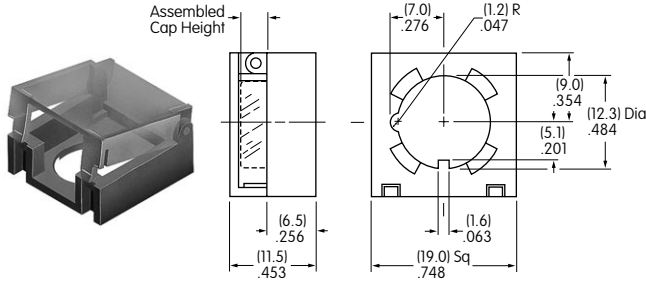

AT4024 Protective Guard For Rectangular (not for Barrier type)

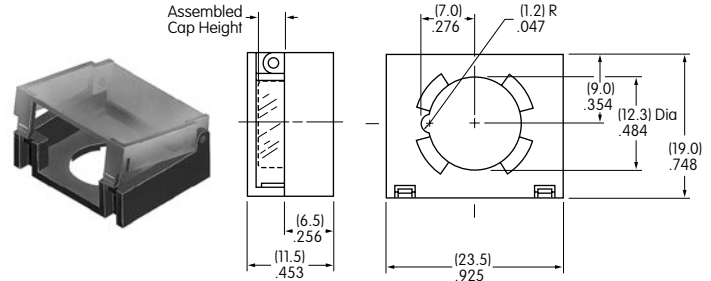

Cover Material: Polycarbonate Base Material: Polyamide

Panel Thickness Range: .020" ~ .268" (0.5 ~ 6.8mm) for Bushing Mounting; .020" ~ .091" (0.5 ~ 2.3mm) for Snap-in Mounting.
Protective Guards reduce the depth of switch behind panel by .047" (1.2mm).

ASSEMBLY INSTRUCTIONS

Cap Removal & Installation

For alternate action models cap must be in UP position for cap removal. Indentations on opposite sides of the cap provide an easy way to lift the cap out of the holder, using either the finger nails, or cap extractor AT109.

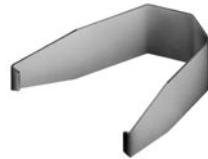
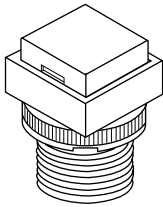

AT109 Cap Extractor

Cap Replacement

Note that the cap has a pair of round tabs and a pair of long tabs which should be used for correctly replacing the cap in its holder. Using the long tabs as guides, slide the cap with the long tabs moving into the slots on opposite sides of the cap holder. Then, the round tabs will snap into notches on the other two sides of the holder.

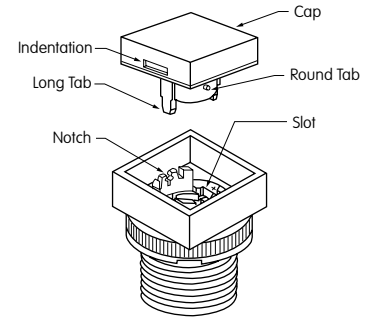

LEGENDS

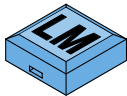

Easily create and submit your own legends using our new on-line Legend Maker.

Visit www.nkkswitches.com

For other legend support options, customers may either contact the factory and request the EB Legend Packet, or utilize the general information and basic specifications presented below.

Suggested Printable Area for Lens

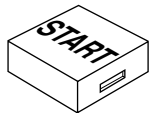

Recommended Methods:
Laser Etch on clear lens, Screen Print or Pad Print on lens.
Epoxy based ink is recommended.

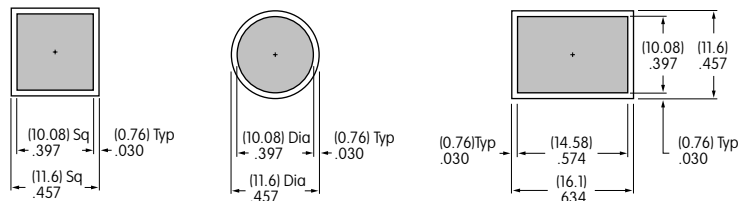

Shaded areas are printable areas.

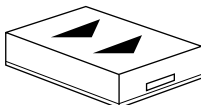

Additional Method: Maximum depth for engraving is .012" (0.3mm) on the cap lens. Enamel paint is recommended to fill the engraved area.