

NCP4423, NCP4424, NCP4425

3 A Dual High-Speed MOSFET Drivers

The NCP4423/4424/4425 are MOSFET drivers that are capable of giving reliable service in demanding electrical environments.

Although primarily intended for driving power MOSFETs, these drivers are well-suited for driving other loads (capacitive, resistive, or inductive) which require a low impedance driver capable of high peak currents and fast switching times. Applications such as heavily loaded clock lines, coaxial cables, or piezoelectric transducers can all be driven with the NCP4423/4424/4425. The only known limitation on loading is that the total power dissipated of the driver must be kept within the maximum power dissipation limits of the package.

Features

- High Peak Output Current (3 A)
- Wide Operating Range (4.5 V to 18 V)
- High Capacitive Load Drive Capability (1800 pF in 25 nsec)
- Short Delay Times (< 40 nsec Typ)
- Matched Rise/Fall Times
- Low Supply Current
 - With Logic "1" Input (3.5 mA)
 - With Logic "0" Input (350 μ A)
- Low Output Impedance (3.5 Ω Typ)
- Latch-Up Protected: Will Withstand 1.5 A Reverse Current
- Logic Input Will Withstand Negative Swing Up to 5 V
- ESD Protected (4 kV)

FUNCTIONAL BLOCK DIAGRAM

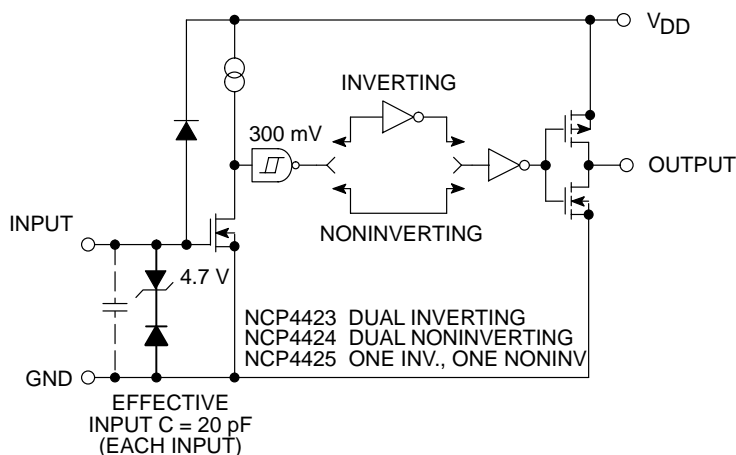

NOTES:

1. NCP4425 has one inverting and one noninverting driver.
2. Ground any unused driver input.



ON Semiconductor

<http://onsemi.com>

MARKING DIAGRAM

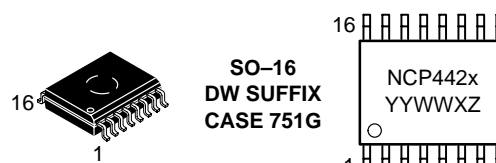

x = Device Number (3, 4, or 5)
 YY = Year
 WW = Work Week
 X = Assembly ID Code
 Z = Subcontractor ID Code
 CO = Country of Origin

ORDERING INFORMATION

Device	Package	Shipping
NCP4423DWR2	SO-16	1000 Tape & Reel
NCP4424DWR2	SO-16	1000 Tape & Reel
NCP4425DWR2	SO-16	1000 Tape & Reel
NCP4423P	PDIP-8	50 Units/Rail
NCP4424P	PDIP-8	50 Units/Rail
NCP4425P	PDIP-8	50 Units/Rail

NCP4423, NCP4424, NCP4425

PIN CONNECTIONS

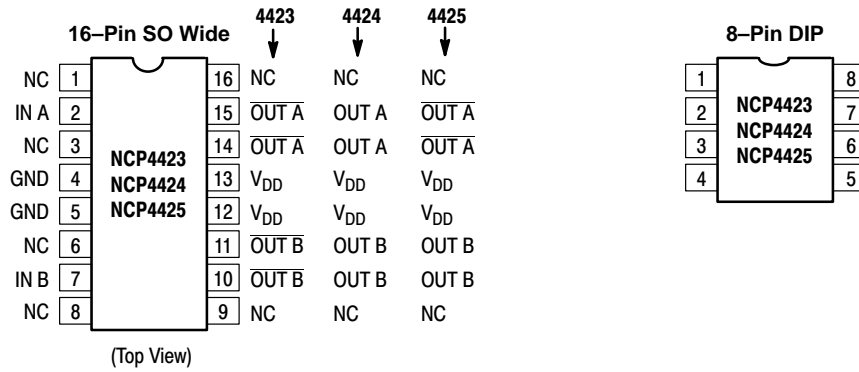

NC = NO CONNECTION

NOTE: Duplicate pins must **both** be connected for proper operation.

NCP4423, NCP4424, NCP4425

ABSOLUTE MAXIMUM RATINGS

Rating	Value	Unit
Supply Voltage	+22	V
Input Voltage, IN A or IN B ($V_{DD} + 0.3$ V to GND – 5.0 V)	–5	V
Maximum Chip Temperature	+150	°C
Storage Temperature Range, T_{stg}	–65 to +150	°C
Lead Temperature (Soldering, 10 sec)	+300	°C
Package Thermal Resistance SOIC, $R_{\theta JA}$ PDIP, $R_{\theta JA}$ PDIP, $R_{\theta JC}$	155 –125 –45	°C/W
Operating Temperature Range	–40 to +85	°C
Package Power Dissipation ($T_A \leq 70^\circ\text{C}$) SOIC PDIP	470 730	mW mc

ELECTRICAL CHARACTERISTICS ($T_A = +25^\circ\text{C}$ with $4.5\text{ V} \leq V_{DD} \leq 18\text{ V}$, unless otherwise specified.)

Characteristic	Symbol	Test Conditions	Min	Typ	Max	Unit
----------------	--------	-----------------	-----	-----	-----	------

Input

Logic 1 High Input Voltage	V_{OH}	–	2.4	–	–	V
Logic 0 Low Input Voltage	V_{IL}	–	–	–	0.8	V
Input Current	I_{IN}	$0\text{ V} \leq V_{IN} \leq V_{DD}$	–1.0	–	1.0	μA

Output

High Output Voltage	V_{OH}	–	$V_{DD} - 0.025$	–	–	V
Low Output Voltage	V_{OL}	–	–	–	0.025	V
Output Resistance, High	R_{OH}	$I_{OUT} = 10\text{ mA}$, $V_{DD} = 18\text{ V}$	–	2.8	5.0	Ω
Output Resistance, Low	R_{OL}	$I_{OUT} = 10\text{ mA}$, $V_{DD} = 18\text{ V}$	–	3.5	5.0	Ω
Peak Output Current	I_{PK}	–	–	3.0	–	A
Latch-Up Protection Withstand Reverse Current	I_{REV}	Duty Cycle $\leq 2\%$ $t \leq 300\ \mu\text{s}$	1.5	–	–	A

Switching Time (Note 1.)

Rise Time	t_R	Figure 1, $C_L = 1800\text{ pF}$	–	23	35	nsec
Fall Time	t_F	Figure 1, $C_L = 1800\text{ pF}$	–	25	35	nsec
Delay Time 1	t_{D1}	Figure 1, $C_L = 1800\text{ pF}$	–	33	75	nsec
Delay Time 2	t_{D2}	Figure 1, $C_L = 1800\text{ pF}$	–	38	75	nsec

Power Supply

Power Supply Current	I_S	$V_{IN} = 3.0\text{ V}$ (Both Inputs) $V_{IN} = 0\text{ V}$ (Both Inputs)	– –	1.5 0.15	2.5 0.25	mA
----------------------	-------	--	--------	-------------	-------------	----

1. Switching times guaranteed by design.

NCP4423, NCP4424, NCP4425

ELECTRICAL CHARACTERISTICS (Over operating temperature range with $4.5\text{ V} \leq V_{DD} \leq 18\text{ V}$, unless otherwise specified.)

Characteristic	Symbol	Test Conditions	Min	Typ	Max	Unit
Input						
Logic 1 High Input Voltage	V_{IH}	–	2.4	–	–	V
Logic 0 Low Input Voltage	V_{IL}	–	–	–	0.8	V
Input Current	I_{IN}	$0\text{ V} \leq V_{IN} \leq V_{DD}$	–10	–	10	μA

Output						
High Output Voltage	V_{OH}	–	$V_{DD} - 0.025$	–	–	V
Low Output Voltage	V_{OL}	–	–	–	0.025	V
Output Resistance, High	R_O	$I_{OUT} = 10\text{ mA}$, $V_{DD} = 18\text{ V}$	–	3.7	8.0	Ω
Output Resistance, Low	R_O	$I_{OUT} = 10\text{ mA}$, $V_{DD} = 18\text{ V}$	–	4.3	8.0	Ω
Peak Output Current	I_{PK}	–	–	3.0	–	A
Latch-Up Protection Withstand Reverse Current	I_{REV}	Duty Cycle $\leq 2\%$ $t \leq 300\ \mu\text{sec}$	1.5	–	–	A

Switching Time (Note 1.)

Rise Time	t_R	Figure 1, $C_L = 1800\text{ pF}$	–	28	60	nsec
Fall Time	t_F	Figure 1, $C_L = 1800\text{ pF}$	–	32	60	nsec
Delay Time 1	t_{D1}	Figure 1, $C_L = 1800\text{ pF}$	–	32	100	nsec
Delay Time 2	t_{D2}	Figure 1, $C_L = 1800\text{ pF}$	–	38	100	nsec

Power Supply

Power Supply Current	I_S	$V_{IN} = 3.0\text{ V}$ (Both Inputs) $V_{IN} = 0\text{ V}$ (Both Inputs)	–	2.0	3.5	mA
			–	0.2	0.3	

1. Switching times guaranteed by design.

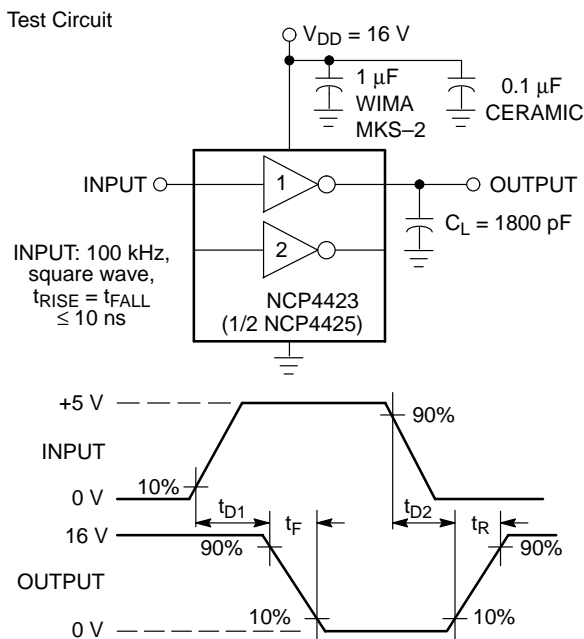

Figure 1. Inverting Driver Switching Time

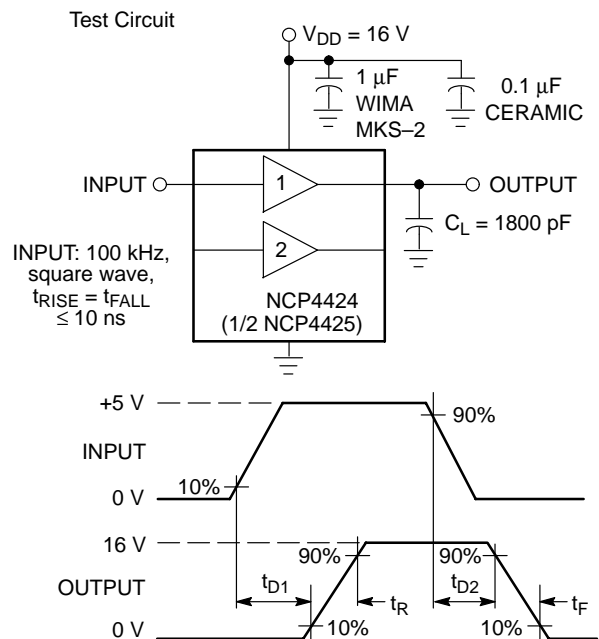

Figure 2. Noninverting Driver Switching Time

NCP4423, NCP4424, NCP4425

TYPICAL ELECTRICAL CHARACTERISTICS

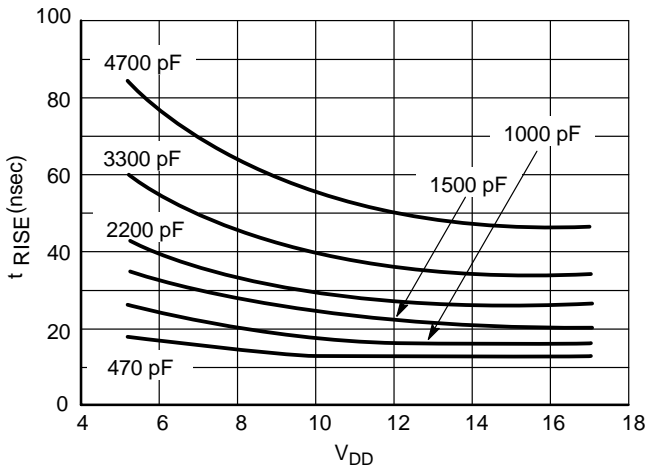

Figure 3. Rise Time vs. Supply Voltage

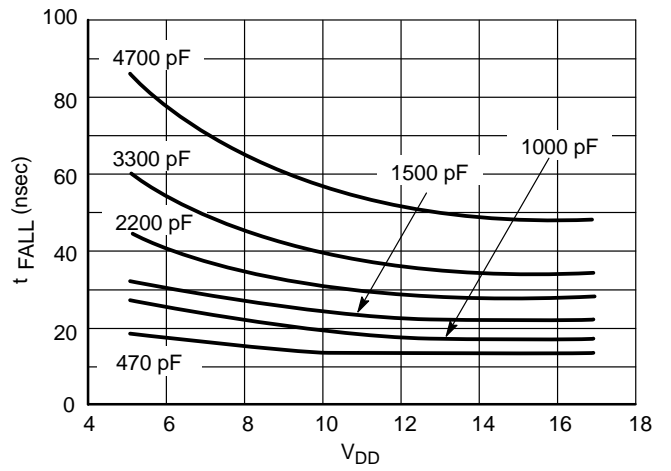

Figure 4. Fall Time vs. Supply Voltage

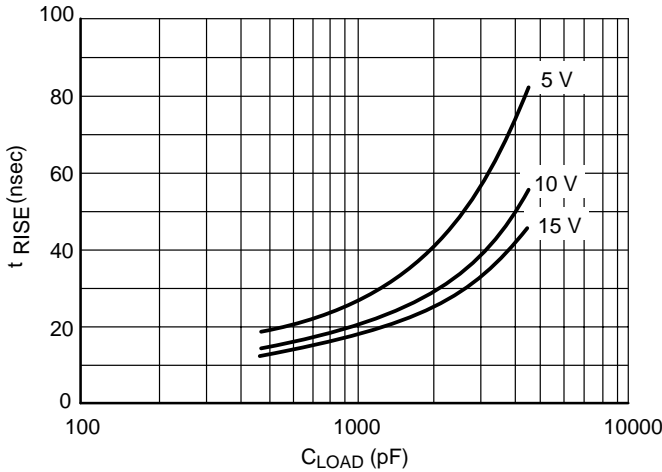

Figure 5. Rise Time vs. Capacitive Load

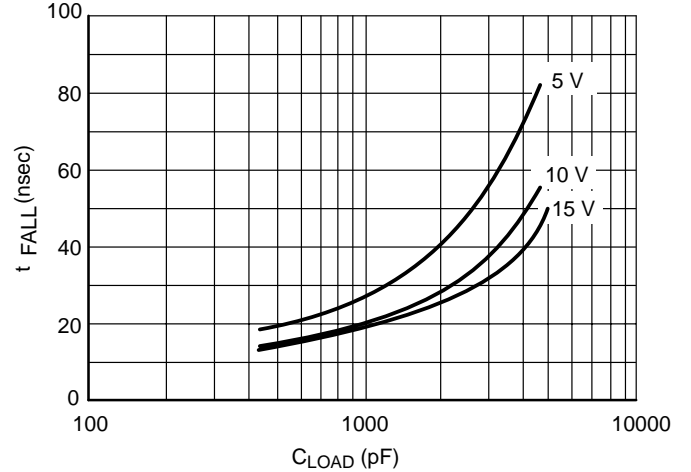

Figure 6. Fall Time vs. Capacitive Load

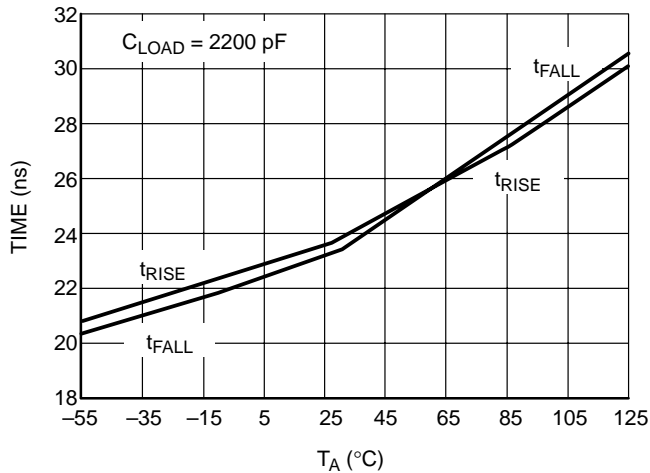

Figure 7. Rise and Fall Times vs. Temperature

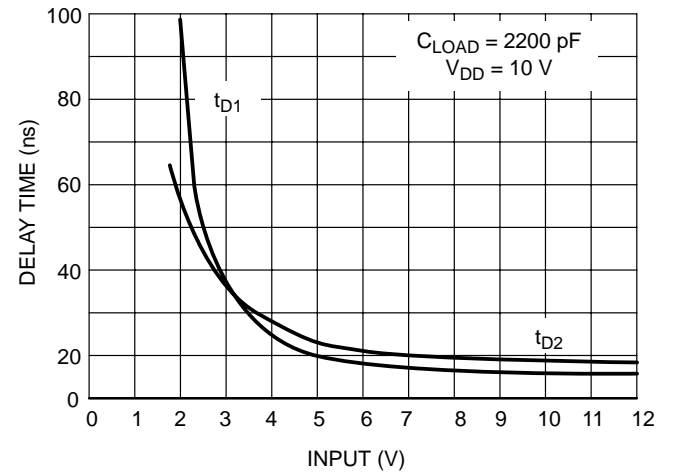

Figure 8. Propagation Delay vs. Input Amplitude

NCP4423, NCP4424, NCP4425

TYPICAL ELECTRICAL CHARACTERISTICS

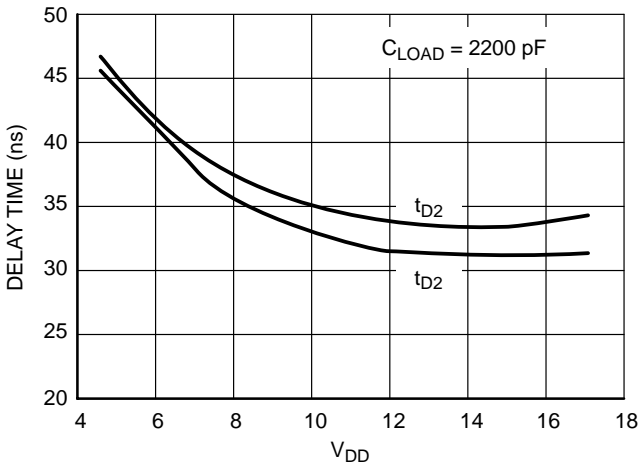

Figure 9. Propagation Delay Time vs. Supply Voltage

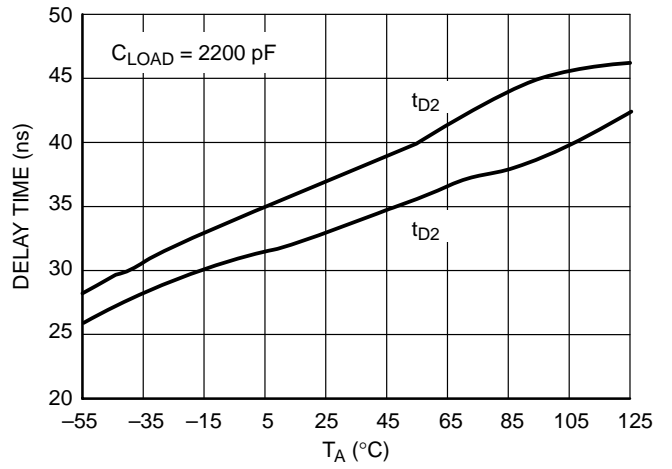

Figure 10. Delay Time vs. Temperature

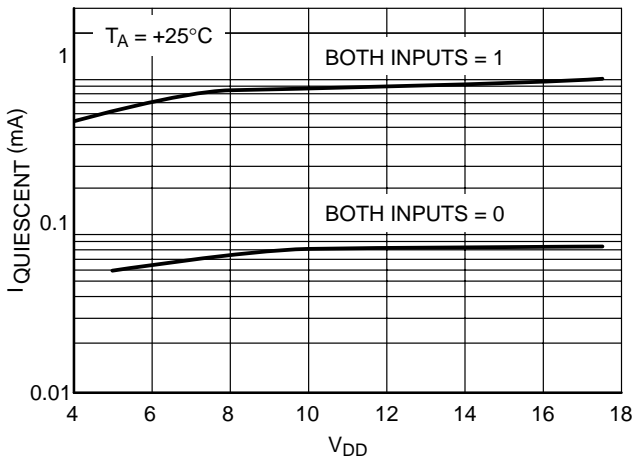

Figure 11. Quiescent Current vs. Supply Voltage

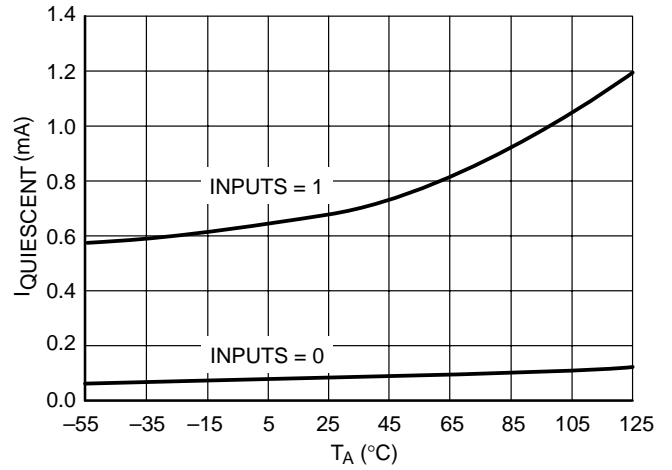

Figure 12. Quiescent Current vs. Temperature

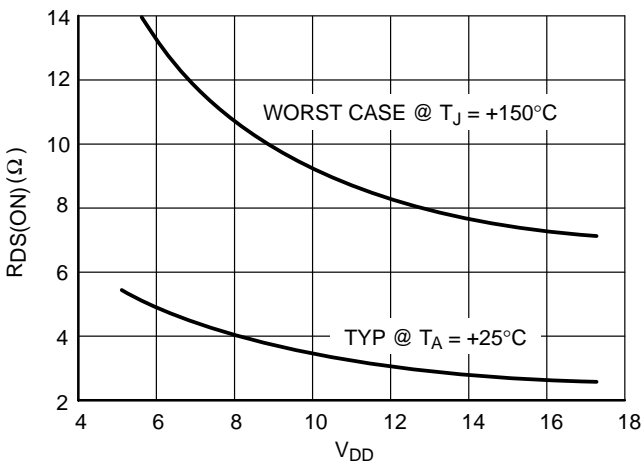

Figure 13. Output Resistance (Output High) vs. Supply Voltage

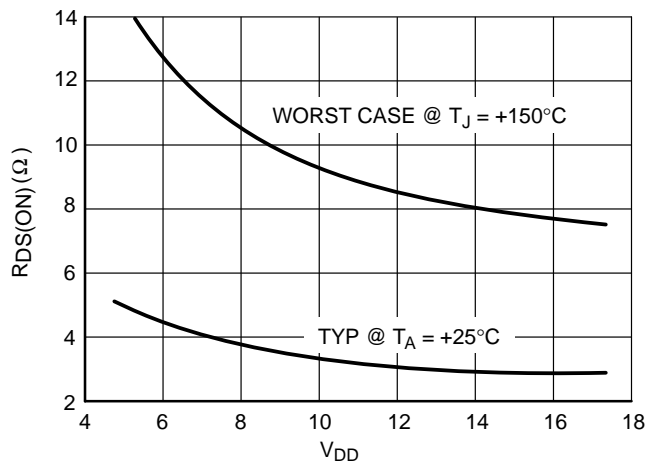

Figure 14. Output Resistance (Output Low) vs. Supply Voltage

NCP4423, NCP4424, NCP4425

TYPICAL ELECTRICAL CHARACTERISTICS

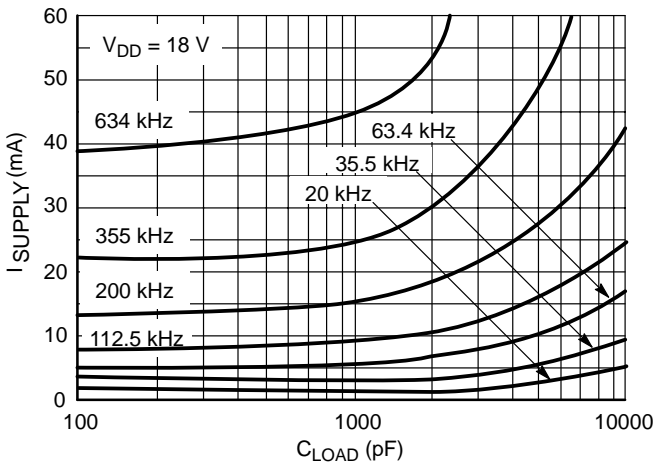

Figure 15. Supply Current vs. Capacitive Load

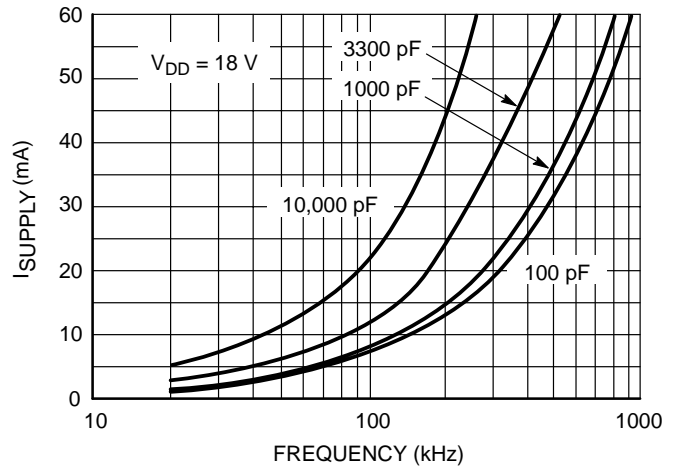

Figure 16. Supply Current vs. Frequency

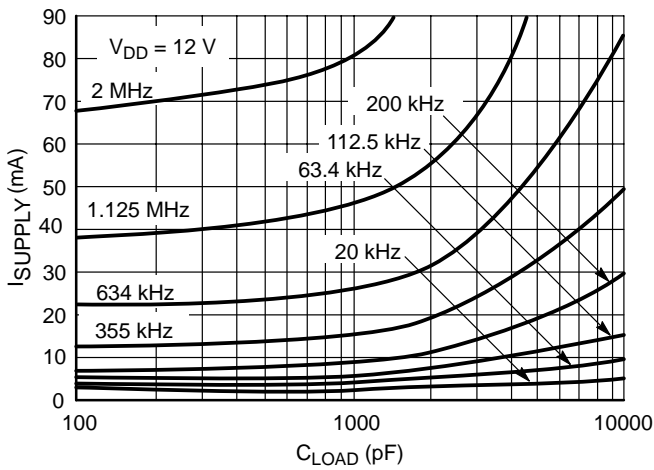

Figure 17. Supply Current vs. Capacitive Load

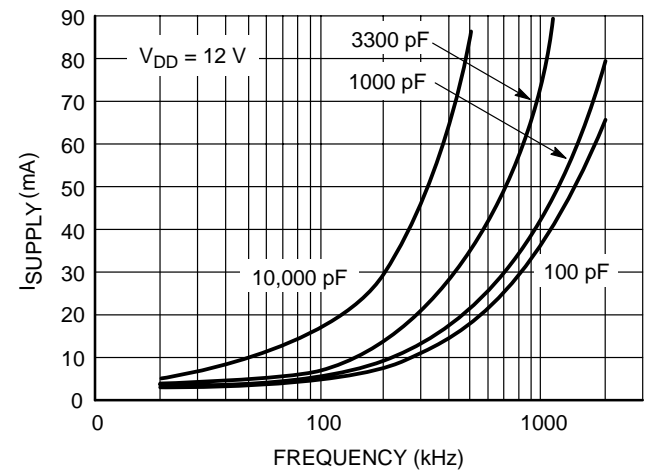

Figure 18. Supply Current vs. Frequency

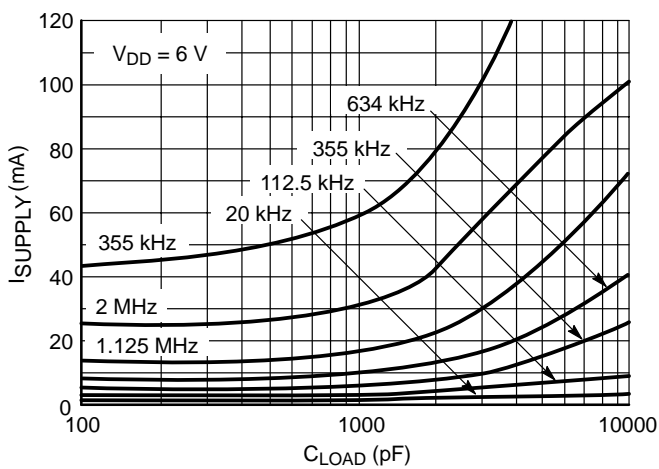

Figure 19. Supply Current vs. Capacitive Load

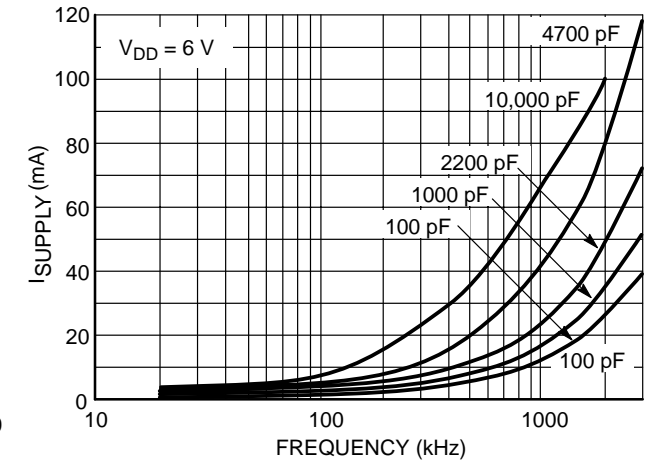

Figure 20. Supply Current vs. Frequency

NCP4423, NCP4424, NCP4425

TYPICAL ELECTRICAL CHARACTERISTICS

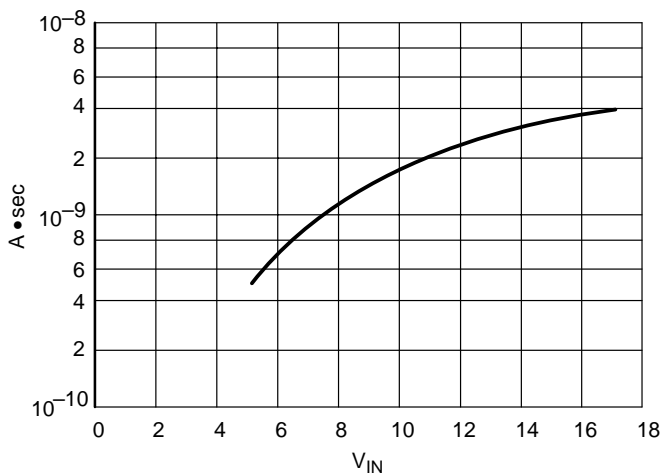

Figure 21. NCP4423 Crossover Energy

NOTE: The values on this graph represent the loss seen by both drivers in a package during one complete cycle. For a single driver, divide the stated values by 2. For a single transition of a single driver, divide the stated value by 4.

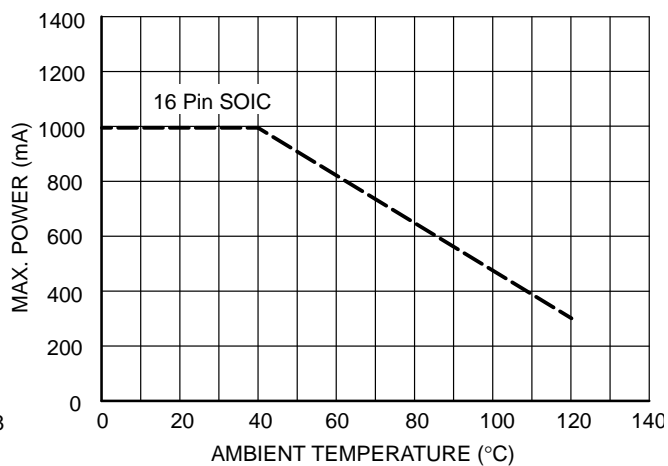

Figure 22. Thermal Derating Curves

Static-sensitive device. Unused devices must be stored in conductive material. Protect devices from static discharge and static fields. Stresses above those listed under Absolute Maximum Ratings (See page 2) may cause permanent damage to the device. These are stress ratings only and functional operation of the device at these or any other conditions above those indicated in the operational sections of the specifications is not implied. Exposure to Absolute Maximum Rating Conditions for extended periods may affect device reliability.

NCP4423, NCP4424, NCP4425

PACKAGE DIMENSIONS

PDIP-8
P SUFFIX
 CASE 626-05
 ISSUE K

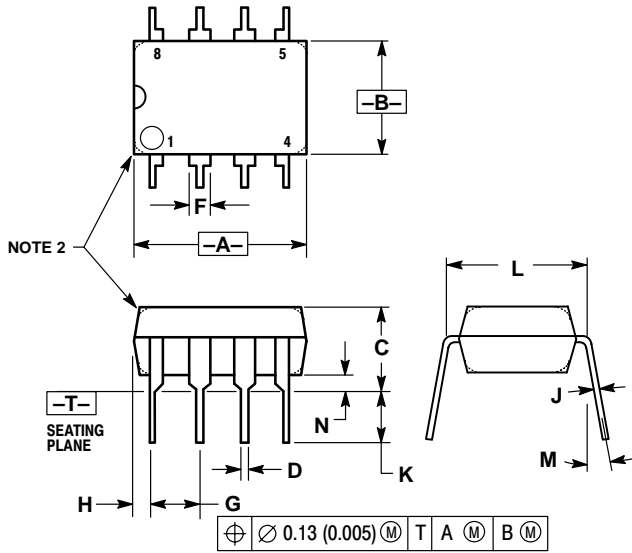

NOTES:

1. DIMENSION L TO CENTER OF LEAD WHEN FORMED PARALLEL.
2. PACKAGE CONTOUR OPTIONAL (ROUND OR SQUARE CORNERS).
3. DIMENSIONING AND TOLERANCING PER ANSI Y14.5M, 1982.

DIM	MILLIMETERS		INCHES	
	MIN	MAX	MIN	MAX
A	9.40	10.16	0.370	0.400
B	6.10	6.60	0.240	0.260
C	3.94	4.45	0.155	0.175
D	0.38	0.51	0.015	0.020
F	1.02	1.78	0.040	0.070
G	2.54 BSC		0.100 BSC	
H	0.76	1.27	0.030	0.050
J	0.20	0.30	0.008	0.012
K	2.92	3.43	0.115	0.135
L	7.62 BSC		0.300 BSC	
M	---	10°	---	10°
N	0.76	1.01	0.030	0.040

SO-16
DW SUFFIX
 CASE 751G-03
 ISSUE B

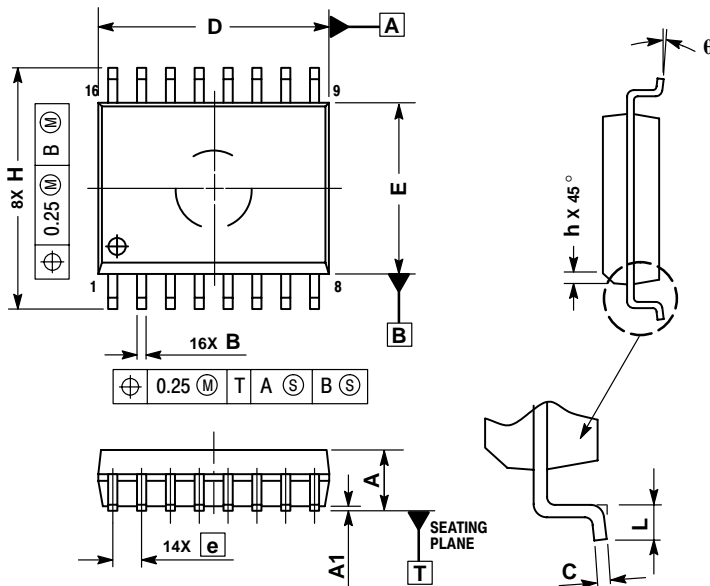

NOTES:

1. DIMENSIONS ARE IN MILLIMETERS.
2. INTERPRET DIMENSIONS AND TOLERANCES PER ASME Y14.5M, 1994.
3. DIMENSIONS D AND E DO NOT INCLUDE MOLD PROTRUSION.
4. MAXIMUM MOLD PROTRUSION 0.15 PER SIDE.
5. DIMENSION B DOES NOT INCLUDE DAMBAR PROTRUSION. ALLOWABLE DAMBAR PROTRUSION SHALL BE 0.13 TOTAL IN EXCESS OF THE B DIMENSION AT MAXIMUM MATERIAL CONDITION.

DIM	MILLIMETERS	
	MIN	MAX
A	2.35	2.65
A1	0.10	0.25
B	0.35	0.49
C	0.23	0.32
D	10.15	10.45
E	7.40	7.60
e	1.27 BSC	
H	10.05	10.55
h	0.25	0.75
L	0.50	0.90
θ	0°	7°

NCP4423, NCP4424, NCP4425

Notes

NCP4423, NCP4424, NCP4425

Notes

NCP4423, NCP4424, NCP4425

ON Semiconductor and  are trademarks of Semiconductor Components Industries, LLC (SCILLC). SCILLC reserves the right to make changes without further notice to any products herein. SCILLC makes no warranty, representation or guarantee regarding the suitability of its products for any particular purpose, nor does SCILLC assume any liability arising out of the application or use of any product or circuit, and specifically disclaims any and all liability, including without limitation special, consequential or incidental damages. "Typical" parameters which may be provided in SCILLC data sheets and/or specifications can and do vary in different applications and actual performance may vary over time. All operating parameters, including "Typicals" must be validated for each customer application by customer's technical experts. SCILLC does not convey any license under its patent rights nor the rights of others. SCILLC products are not designed, intended, or authorized for use as components in systems intended for surgical implant into the body, or other applications intended to support or sustain life, or for any other application in which the failure of the SCILLC product could create a situation where personal injury or death may occur. Should Buyer purchase or use SCILLC products for any such unintended or unauthorized application, Buyer shall indemnify and hold SCILLC and its officers, employees, subsidiaries, affiliates, and distributors harmless against all claims, costs, damages, and expenses, and reasonable attorney fees arising out of, directly or indirectly, any claim of personal injury or death associated with such unintended or unauthorized use, even if such claim alleges that SCILLC was negligent regarding the design or manufacture of the part. SCILLC is an Equal Opportunity/Affirmative Action Employer.

PUBLICATION ORDERING INFORMATION

NORTH AMERICA Literature Fulfillment:

Literature Distribution Center for ON Semiconductor
P.O. Box 5163, Denver, Colorado 80217 USA
Phone: 303-675-2175 or 800-344-3860 Toll Free USA/Canada
Fax: 303-675-2176 or 800-344-3867 Toll Free USA/Canada
Email: ONlit@hibbertco.com
Fax Response Line: 303-675-2167 or 800-344-3810 Toll Free USA/Canada

N. American Technical Support: 800-282-9855 Toll Free USA/Canada

EUROPE: LDC for ON Semiconductor – European Support

German Phone: (+1) 303-308-7140 (Mon-Fri 2:30pm to 7:00pm CET)
Email: ONlit-german@hibbertco.com
French Phone: (+1) 303-308-7141 (Mon-Fri 2:00pm to 7:00pm CET)
Email: ONlit-french@hibbertco.com
English Phone: (+1) 303-308-7142 (Mon-Fri 12:00pm to 5:00pm GMT)
Email: ONlit@hibbertco.com

EUROPEAN TOLL-FREE ACCESS*: 00-800-4422-3781

*Available from Germany, France, Italy, UK, Ireland

CENTRAL/SOUTH AMERICA:

Spanish Phone: 303-308-7143 (Mon-Fri 8:00am to 5:00pm MST)
Email: ONlit-spanish@hibbertco.com

ASIA/PACIFIC: LDC for ON Semiconductor – Asia Support

Phone: 303-675-2121 (Tue-Fri 9:00am to 1:00pm, Hong Kong Time)
Toll Free from Hong Kong & Singapore:
001-800-4422-3781
Email: ONlit-asia@hibbertco.com

JAPAN: ON Semiconductor, Japan Customer Focus Center
4-32-1 Nishi-Gotanda, Shinagawa-ku, Tokyo, Japan 141-0031
Phone: 81-3-5740-2700
Email: r14525@onsemi.com

ON Semiconductor Website: <http://onsemi.com>

For additional information, please contact your local Sales Representative.