

NJM2904

The NJM2904 consists of two independent, high gain, internally frequency compensated operation amplifiers which were designed specifically to operate from a single power supply over a wide range of voltages. Operation from split power supplies is also possible and the low power supply current drain is independent of the magnitude of the power supply voltage.

Application areas include transducer amplifiers, DC gain blocks, and all the conventional op amp circuits which now can be more easily implemented in single power supply systems. For example, the NJM2904 can be directly operated off of the standard +5V power supply voltage which is used in digital systems and will easily provide the required interface electronics without requiring the additional $\pm 15V$ power supplies.

Absolute Maximum Ratings (Ta=25°C)

Supply Voltage	V ⁺ (V ⁺ /V ⁻)	32V (or $\pm 16V$)
Differential Input Voltage	V _{ID}	32V
Input Voltage	V _I	-0.3~+32V
Power Dissipation	P _D (D-Type)	500mW
	(M-Type)	300mW
	(L-Type)	800mW
Operating Temperature Range	T _{opr}	-40~+85°C
Storage Temperature Range	T _{stg}	-50~+125°C

Package Outline

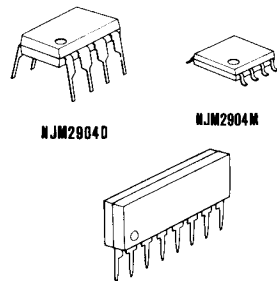

Electrical Characteristics (Ta=25°C, V⁺=5V)

Parameter	Symbol	Test Condition	Min.	Typ.	Max.	Unit
Input Offset Voltage	V _{IO}	R _S =0Ω	—	2	7	mV
Input Offset Current	I _{IO}		—	5	50	nA
Input Bias Current	I _B		—	25	250	nA
Large Signal Voltage Gain	A _V	R _L ≥ 2kΩ	—	100	—	dB
Maximum Output Voltage Swing	V _{OPP}	R _L = 2kΩ	3.5	—	—	V
Input Common Mode Voltage Range	V _{ICM}		0	—	3.5	V
Common Mode Rejection Ratio	CMR		—	85	—	dB
Supply Voltage Rejection Ratio	SVR		—	100	—	dB
Output Source Current	I _{SOURCE}	V _{IN} ⁺ = 1V, V _{IN} ⁻ = 0V	20	30	—	mA
Output Sink Current	I _{SINK}	V _{IN} ⁺ = 0V, V _{IN} ⁻ = 1V	8	20	—	mA
Channel Separation	CS	f = 1k~20kHz, Input Referred	—	120	—	dB
Supply Current	I _{CC}	R _L = ∞	—	0.7	1.2	mA
Slew Rate	SR		—	0.5	—	V/μs
Gain Bandwidth Product	GB		—	0.2	—	MHz

Equivalent Circuit (1/2 Shown)

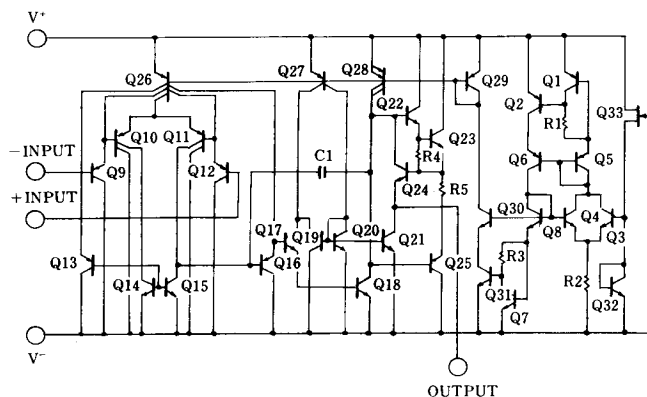

Connection Diagrams

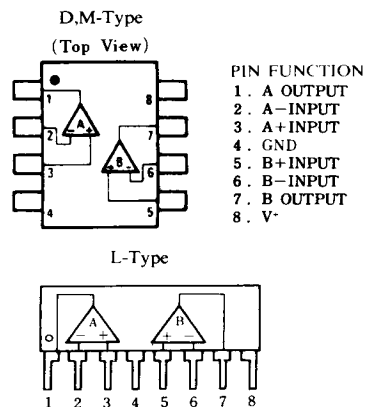

■ Typical Characteristics

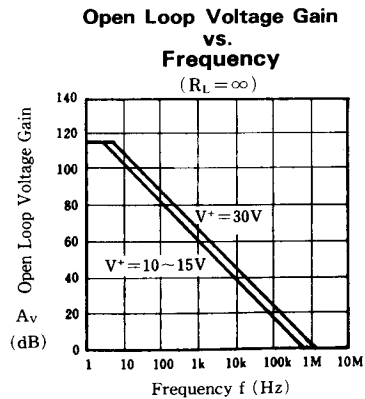
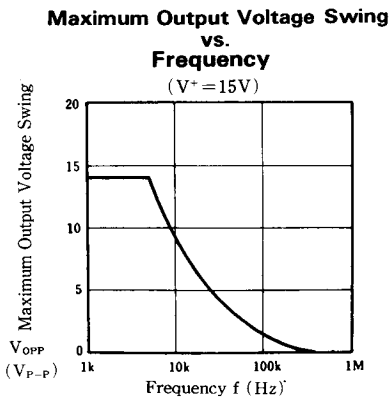
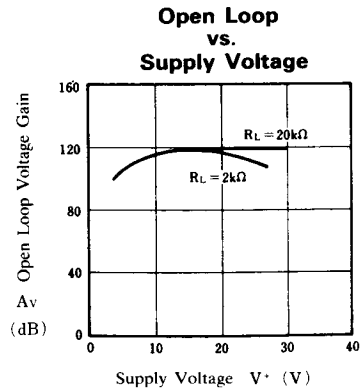
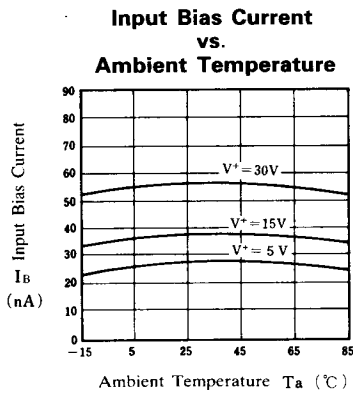
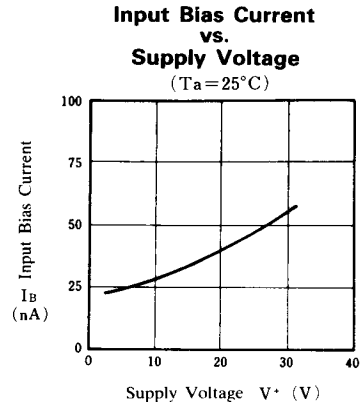
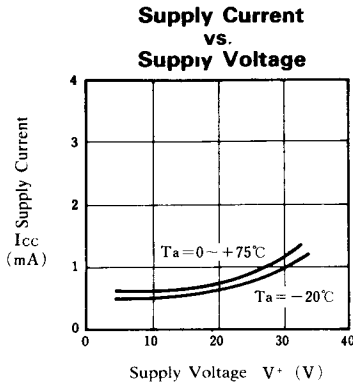

■ Typical Characteristics

2

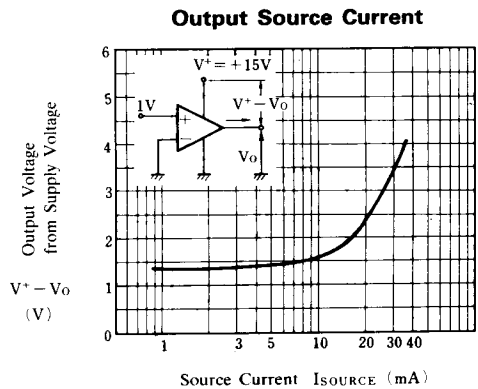
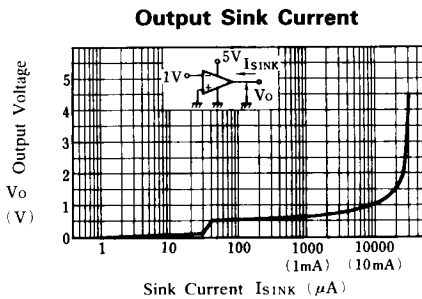
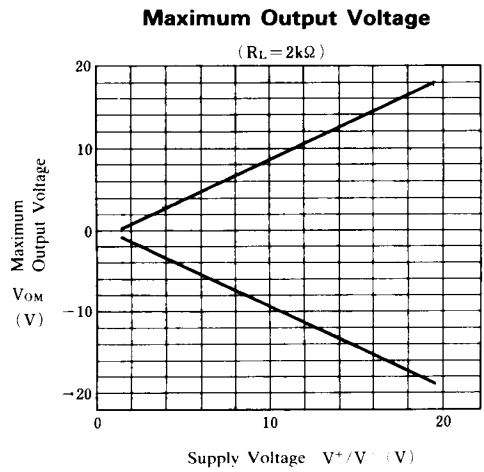
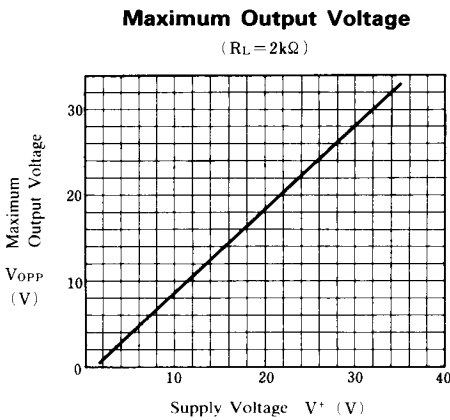
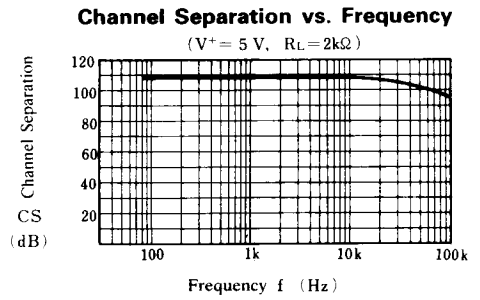
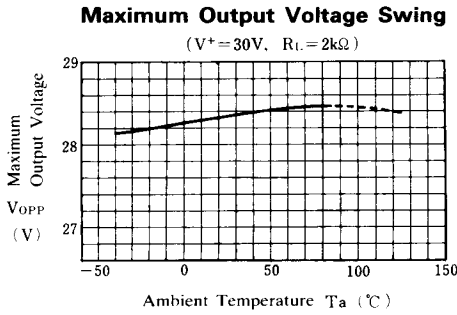

■ Typical Characteristics

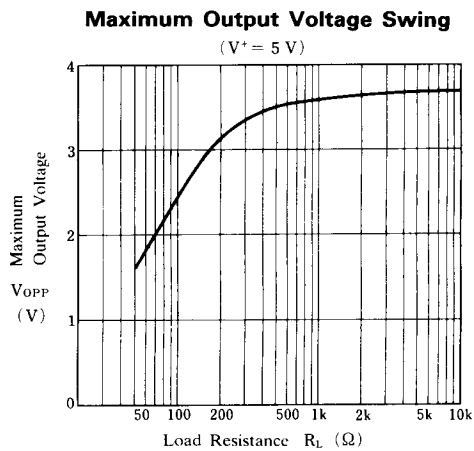

2